

Top 100
Global
Innovator
for 10 years

Metasol Meta Solution

MC/TOR

Contactors and Overload Relays



LS ELECTRIC

Metasol Contactors and overload relays

New Generation of Contactors From LS



Designed to show superior technology: Metasol series

Sealed structure has improved its safety features so that no arc flash is exposed. In order to emphasize its durability as an industrial device, Metasol series adopt simple design form and sophisticated shape applying diamond cut concepts on product surface.



Contents

Table of specifications	10
Type numbering system	20
Environment	22
Connections	23
Control coil characteristics	24
Marking	28
Internal structure	29
Contactors	30
Motor starters	54
Reversing contactors	58
LED voltage monitoring contactor	60
Contactor relays	61
Latching contactors	64
4-pole contactors	68
Enclosed motor starters, Mold enclosure	80
Enclosed motor starters, Steel enclosure	81
Capacitor contactors	82
2-pole AC contactors, Definite purpose	83
3-pole AC contactors, Definite purpose	84
Single-pole AC contactors, Definite purpose	85
2-pole DC contactors	86
Accessory	87
Overload relays	98
Overload relay specifications	100
Overload relay operation	104
Accessories for overload relay	105
Overload relay ordering types	110
Overload relay trip curves	116
Type 2 coordination (440V)	124
Rated UL 508 combination motor controller Type-C	131
Rated UL 508 combination motor controller Type-D	135
Rated UL 508 combination motor controller Type-F	138
Ready for IE3	141
Dimension	142
Delayed opening device	178
Electronic timer unit	179
Contact arrangement	180
Comparison table	183
Certifications	189

Metasol Series completion



More Safe,
More Valuable



Contactors & Overload Relays



- *Advanced technology & Expert solution*
- *Offering economical solution with compact size & easy connection*
- *Ensure reliability in the system: Type II Coordination*
- *Perfect system with peripheral devices.*
- *Environment friendly product: complies with International environment standard RoHS.*
- *25 Models in 9 Frames*
- *Ready for IE3*

Contactors and overload relays

Motor Starters

- Compact design for space saving
- DIN rail and screw mountable (upto 150AF)
- Overload relays directly mountable to contactors separately
- Finger-proof design
- Easy to combine with manual motor starters
- Broad range of accessories
- World class products conforming to IEC and UL standards



18AF

Contactor

MC-6a, 9a, 12a, 18a

Rated current:
6, 9, 12, 18A

Rated insulation voltage:
690V

Overload relay MT-12

Current range: 0.1~18A
Trip class: Class10A, 20

22AF

Contactor

MC-9b, 12b, 18b, 22b

Rated current:
9, 12, 18, 22A

Rated insulation voltage:
690V

Overload relay MT-32

Current range: 0.1~40A
Trip class: Class10A, 20

40AF

Contactor

MC-32a, 40a

Rated current:
32, 40A

Rated insulation voltage:
1000V

Overload relay MT-32

Current range: 0.1~40A
Trip class: Class10A, 20

65AF

Contactor

MC-50a, 65a

Rated current:
50, 65A

Rated insulation voltage:
1000V

Overload relay MT-63

Current range: 4~65A
Trip class: Class10A, 20

100AF

Contactor

MC-75a, 85a, 100a

Rated current:
75, 85, 100A

Rated insulation voltage:
1000V

Overload relay MT-95

Current range: 7~100A
Trip class: Class10A, 20

150AF

Contactor

MC-130a, 150a

Rated current:
130, 150A

Rated insulation voltage:
1000V

Overload relay MT-150

Current range: 34~150A
Trip class: Class10A, 20

MS-500a, MS-630a, MS-800a

MS-185a, MS-225a
MS-265a, MS-330a, MS-400a



225AF



400AF



800AF

225AF

Contactor

MC-185a, 225a

Rated current:

185, 225A

Rated insulation voltage:
1000V

Overload relay MT-225

Current range: 65~240A

Trip class: Class10A, 20

400AF

Contactor

MC-265a, 330a, 400a

Rated current:

265, 330, 400A

Rated insulation voltage:
1000V

Overload relay MT-400

Current range: 85~400A

Trip class: Class10A, 20

800AF

Contactor

MC-500a, 630a, 800a

Rated current:

500, 630, 800A

Rated insulation voltage:
1000V

Overload relay MT-800

Current range: 200~800A

Trip class: Class10A, 20

1260AF

Contactor

MC-1260a

Rated current:

1260A

Rated insulation voltage:
1000V

2650AF

Contactor

**MC-1400a, 1700a, 2100a,
2650a**

Rated current:

1400, 1700, 2100, 2650A

Rated insulation voltage:
1000V



MC/TOR Accessories

Perfect combination of peripheral devices and various accessories

Offering economical solution with compact size & easy connection



Perfect system with other devices and accessories

■ One-touch connection

- Din Rail connection without any special tools
- Direct combine a surge unit

■ Simple wiring

- Mounting unit, Adapter
- Reversing wire set

■ Easy maintenance

- 4-terminal type: Easy wiring of operation coil
- Module type of screw terminal
- Interlock unit with built-in auxiliary contacts(2NO built-in)

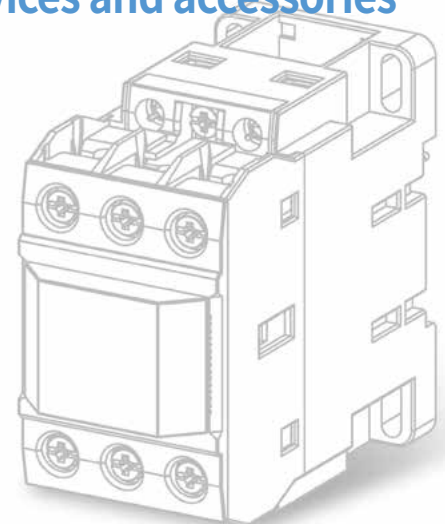

Advanced accessories for Metasol contactors

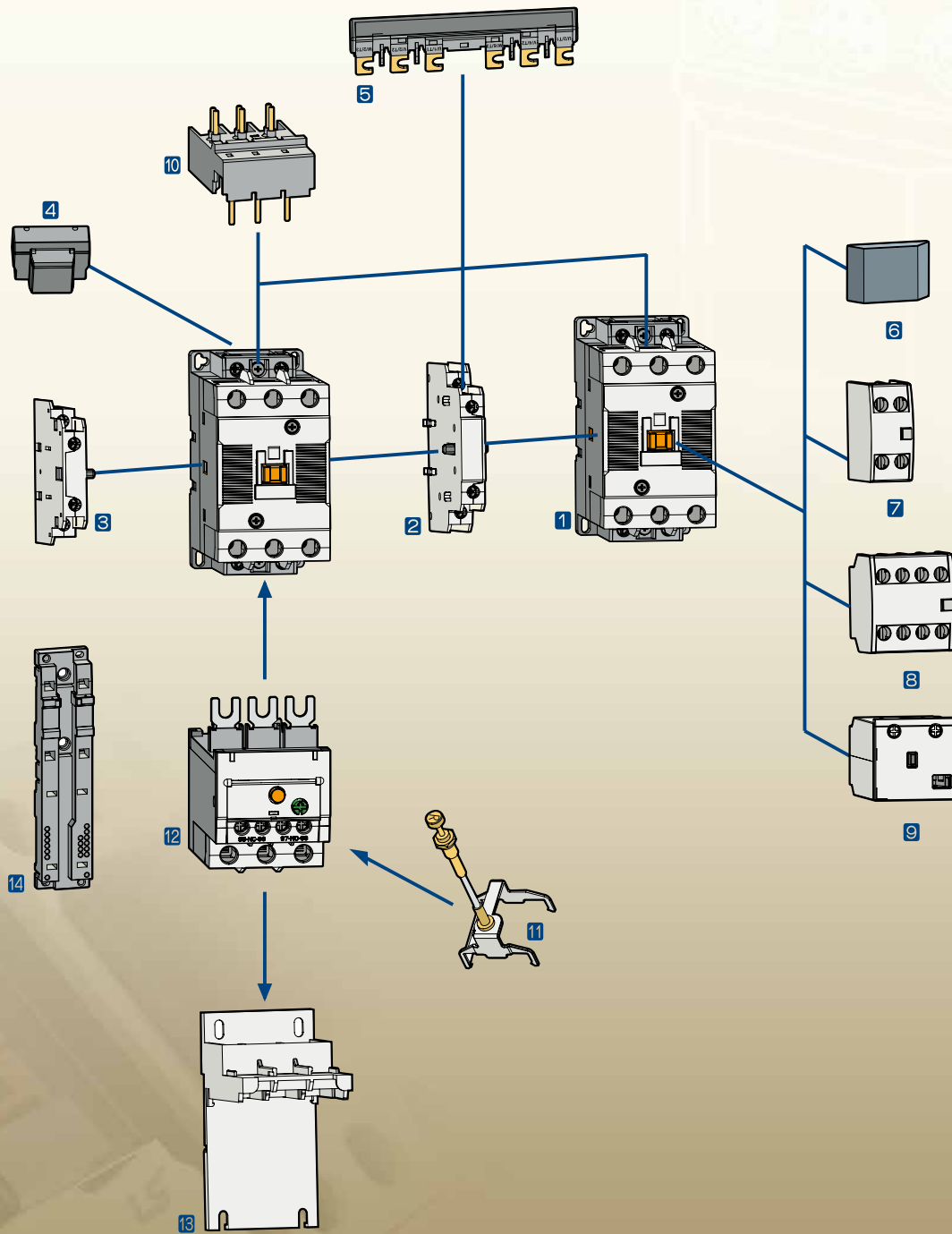

- | | | |
|--|---|-----------------------------------|
| 1 Contactor | 6 Safety cover (Option) | 10 Direct adaptor to MMS |
| 2 Interlock unit | 7 Auxiliary contact unit
- front mount(2p) | 11 Remote reset unit |
| 3 Auxiliary contact unit
- side mount | 8 Auxiliary contact unit
- front mount(4p) | 12 Overload relay |
| 4 Surge unit | 9 Mechanical latch unit | 13 Separate mounting unit |
| 5 Wire kit | | 14 Mounting unit for use with MMS |

Table of specifications

MC type Magnetic Contactors



Frame size		18AF				22AF				
Type	Screws clamp terminals	MC-6a	MC-9a	MC-12a	MC-18a	MC-9b	MC-12b	MC-18b	MC-22b	
	Lug clamp terminals	●	●	●	●	●	●	●	●	
Number of poles		3pole				3pole				
Rated operational voltage(Ue)		690V				690V				
Rated insulation voltage(Ui)		690V				690V				
Rated frequency		50/60Hz				50/60Hz				
Rated impulse withstand voltage, Uimp		6kV				6kV				
Maximum operating rate in operating cycles per hour(AC3)		1800 operations per hour				1800 operations per hour				
Durability	Mechanical	15 mil. operations				15 mil. operations				
	Electrical	2.5 mil. operations				2.5 mil. operations				
Current power	AC-1, Thermal current	[A]	25	25	25	32	25	27	40	45
	AC-3 200/240V	[kW]	2.2	2.5	3.5	4.5	2.5	3.5	4.5	5.5
		[A]	9	11	13	18	11	13	18	22
	380/440V	[kW]	3	4	5.5	7.5	4	5.5	7.5	11
		[A]	7	9	12	18	9	12	18	22
	500/550V	[kW]	3	4	7.5	7.5	4	7.5	7.5	15
		[A]	6	7	12	13	7	12	13	20
	690V	[kW]	3	4	7.5	7.5	4	7.5	7.5	15
		[A]	4	5	9	9	6	9	9	18
	1000V	[kW]	-	-	-	-	-	-	-	-
[A]		-	-	-	-	-	-	-	-	
Rated Short-time withstand current (IEC 60947)	1s	[A]	210	250	280	300	250	280	300	400
	10s	[A]	105	110	120	130	110	120	154	186
	30s	[A]	70	70	80	85	70	80	100	130
	1min	[A]	61	61	61	70	61	61	84	90
	3min	[A]	40	45	47	50	45	50	60	60
	10min	[A]	30	30	30	40	30	30	40	50
	≥15min	[A]	25	26	28	30	26	28	30	45
UL rating (50/60Hz)	Continuous current	[A]	25	25	25	32	25	25	40	40
	Single phase 110~120V	[HP]	0.5	0.5	1	2	0.5	1	2	2
		[HP]	1.5	1.5	2	3	1.5	2	3	3
	Three phase 200~208V	[HP]	2	2	3	7.5	2	3	7.5	7.5
		[HP]	3	3	5	7.5	3	5	7.5	10
	440~480V	[HP]	5	5	7.5	10	5	7.5	10	15
		[HP]	7.5	7.5	10	15	7.5	10	15	20
NEMA size		00	00	0	1	00	0	1		
Size and weight	AC control	Weight	[kg]				0.33			
		Size(W×H×D)	[mm]				45×73.5×80.4			
	DC control	Weight	[kg]				0.41			
		Size(W×H×D)	[mm]				45×73.5×96.6			
Auxiliary(Standard)		1a or 1b								
Auxiliary	Side mount	UA-1				UA-1				
	Front mount	UA-2, UA-4				UA-2, UA-4				

Note) Minimum conduct current of Auxiliary contactor is DC 17V5mA.

MT type Thermal Overload Relays



Type	MT-12/□	MT-32/□
Type	Screws clamp terminals	●
	Lug clamp terminals	●
Rated operational voltage, Ue		690V
Rated insulation voltage, Ui		690V
Rated impulse withstand voltage, Uimp		6kV
Trip class		10A, 20
Setting range		0.1~18A
Size and weight	Weight	[kg]
	Size(W×H×D)	[mm]

* The safety cover of magnetic contactor and thermal overload relay is optional.



40AF		65AF		100AF		
MC-32a	MC-40a	MC-50a	MC-65a	MC-75a	MC-85a	MC-100a
●	●	●	●	●	●	●
3pole		3pole		3pole		
1000V		1000V		1000V		
1000V		1000V		1000V		
50/60Hz		50/60Hz		50/60Hz		
8kV		8kV		8kV		
1800 operations per hour		1200 operations per hour		1200 operations per hour		
12 mil. operations		12 mil. operations		12 mil. operations		
2 mil. operations		2 mil. operations		2 mil. operations		1 mil. operations
55	60	100	115	125	135	160
7.5	11	15	18.5	22	25	30
32	40	55	65	75	85	105
15	18.5	22	30	37	45	55
32	40	50	65	75	85	105
18.5	22	30	33	37	45	55
28	32	43	60	64	75	85
18.5	22	30	33	37	45	55
20	23	28	35	42	45	65
22	22	30	30	37	37	37
17	17	23	23	28	28	28
600	700	1000	1050	1100	1200	1320
260	300	550	700	750	800	900
160	190	330	380	400	450	500
100	120	250	270	300	350	400
70	80	150	200	220	270	270
55	65	90	120	140	170	180
50	60	87	96	114	150	160
50	60	70	100	110	135	160
3	3	3	5	5	7.5	10
5	7.5	10	15	15	15	20
7.5	15	20	25	25	30	30
10	15	25	30	30	40	40
20	30	40	50	50	60	75
25	30	50	60	60	75	75
1P	2				3	
0.55		1.05		1.93		
69×83×90		79×106×119		94×140×135.8		
0.77		1.3		2.8		
69×83×117.1		79×106×146.4		94×140×172.3		
2a2b		2a2b		2a2b		
UA-1		UA-1		UA-1		
UA-2, UA-4		UA-2, UA-4		UA-2, UA-4		



MT-32/□	MT-63/□	MT-95/□
●	●	●
690V	690V	690V
690V	690V	690V
6kV	6kV	6kV
10A, 20	10A, 20	10A, 20
0.1~40A	4~65A	7~100A
0.17	0.31/0.33	0.48/0.5
45×75×90	55×81×100	70×97×110

Table of specifications

MC type Magnetic Contactors



Frame size			150AF		225AF		400AF		
Type			MC-130a	MC-150a	MC-185a	MC-225a	MC-265a	MC-330a	MC-400a
	Screws clamp terminals		●	●	●	●	●	●	●
	Lug clamp terminals		●	●	●	●			
Number of poles			3pole		3pole		3pole		
Rated operational voltage(Ue)			1000V		1000V		1000V		
Rated insulation voltage(Ui)			1000V		1000V		1000V		
Rated frequency			50/60Hz		50/60Hz		50/60Hz		
Rated impulse withstand voltage, Uimp			8kV		8kV		8kV		
Maximum operating rate in operating cycles per hour(AC3)			1200 operations per hour		1200 operations per hour		1200 operations per hour		
Durability	Mechanical		5 mil. operations		5 mil. operations		5 mil. operations		2.5 mil. operations
	Electrical		1 mil. operations		1 mil. operations		1 mil. operations		0.5 mil. operations
Current and power	AC-1, Thermal current	[A]	200	250	300	350	400	500	520
		[kW]	37	45	55	75	80	90	125
	AC-3 200/240V	[A]	130	150	185	225	265	330	400
		[kW]	60	75	90	132	147	160	200
	380/440V	[A]	130	150	185	225	265	330	400
		[kW]	60	70	110	132	147	160	225
	500/550V	[A]	90	100	180	200	225	280	350
		[kW]	55	55	110	140	160	200	250
	690V	[A]	60	60	120	150	185	220	300
		[kW]	75	75	132	132	147	147	147
	1000V	[A]	50	50	90	90	105	105	105
		[kW]							
Rated Short-time withstand current (IEC 60947)	1s	[A]	1350	1800	2000	2500	3500	4000	4600
	10s	[A]	950	1200	1500	1700	2400	3000	4400
	30s	[A]	700	800	1000	1200	1500	2500	2974
	1min	[A]	550	600	800	1000	1100	1700	1846
	3min	[A]	350	450	520	700	800	1000	1313
	10min	[A]	200	300	350	500	600	620	760
	≥15min	[A]	175	280	320	400	500	553	699
UL rating (50/60Hz)	Continuous current	[A]	200	250	300	350	400	500	520
		[HP]	10	15	15	15	-	-	-
	Single phase 110~120V	[HP]	20	25	30	40	-	-	-
		[HP]	40	40	60	60	75	100	125
	Three phase 220~240V	[HP]	40	50	60	75	100	100	150
		[HP]	75	100	125	150	200	200	300
	440~480V	[HP]	75	75	125	150	200	200	300
		[HP]							
550~600V	[HP]								
	[HP]								
Size and weight	AC control	Weight [kg]	2.4		5.4		9.2		
		Size(W×H×D) [mm]	119×158×130.3		138×203×185.1		163×243×204.4		
	DC control	Weight [kg]	2.4		5.4		9.2		
		Size(W×H×D) [mm]	119×158×130.3		138×203×185.1		163×243×204.4		
Auxiliary(Standard)			2a2b		2a2b		2a2b		
Auxiliary	Side mount		UA-1		AU-100, AU-100E (Max.4a4b)		AU-100, AU-100E (Max.4a4b)		
	Front mount		UA-2, UA-4		-		-		

MT type Thermal Overload Relays

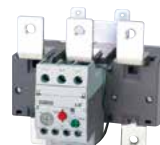

Type		MT150/□	MT225/□	MT400/□
	Screws clamp terminals	●	●	●
	Lug clamp terminals	●	●	
Rated operational voltage, Ue		690V	690V	690V
Rated insulation voltage, Ui		690V	690V	690V
Rated impulse withstand voltage, Uimp		6kV	6kV	6kV
Trip class		10A, 20	10A, 20	10A, 20
Setting range		34~150A	65~240A	85~400A
Size and weight	Weight [kg]	0.67	2.5	2.6
	Size(W×H×D) [mm]	95×109×113	147×141×184	151×171×198

* The safety cover of magnetic contactor and thermal overload relay is optional.



800AF			1260AF	2650AF			
MC-500a	MC-630a	MC-800a	MC-1260a	MC-1400a	MC-1700a	MC-2100a	MC-2650a
●	●	●	●	●	●	●	●
3pole			3pole	3pole			
1000V			1000V	1000V			
1000V			1000V	1000V			
50/60Hz			50/60Hz	50/60Hz			
8kV			8kV	8kV			
1200 operations per hour			300 operations per hour	300 operations per hour			
2.5 mil. operations			0.5 mil. operations	0.5 mil. operations			0.3 mil. operations
0.5 mil. operations			0.05 mil. operations	0.05 mil. operations			0.02 mil. operations
700	900	1050	1260	1400	1700	2100	2650
147	190	220	-	290	310	-	-
500	630	800	-	860	1050	-	-
265	330	440	-	550	700	900	-
500	630	800	-	860	1050	1450	-
265	330	500	-	-	-	-	-
400	500	720	-	-	-	-	-
300	400	500	-	800	1000	-	-
380	420	630	-	800	950	-	-
280	280	280	-	-	-	-	-
220	220	220	-	-	-	-	-
6000	7000	7500	8000	-	-	-	-
5050	6400	7000	7200	8000	10000	10000	-
4400	4500	4900	5200	-	-	-	-
3400	3500	3800	4000	4500	5500	5500	-
2000	2200	2500	2300	-	-	-	-
1400	1550	1550	3000	2600	3000	3000	-
1100	1300	1300	1500	-	-	-	-
700	900	1050	1260	1400	1700	2100	2650
-	-	-	-	-	-	-	-
-	-	-	-	-	-	-	-
150	200	200	-	-	-	-	-
200	250	300	-	-	-	-	-
400	500	600	-	-	-	-	-
400	500	600	-	-	-	-	-
6		7					
22.2 285×310×246			24 285×352×246	33.8 431×380×246			47 431×392×246
22.2 285×310×246			24 285×352×246	33.8 431×380×246			47 431×392×246
2a2b			2a2b	2a2b			
AU-100, AU-100E (Max.4a4b)			AU-100, AU-100E (Max.4a4b)	AU-100, AU-100E (Max.4a4b)			
-			-	-			



MT-800/□	
●	
690V	
690V	
6kV	
10A, 20	
200~800A	
11.5	
360×530×212	

Table of specifications

MC type Magnetic Contactors (4pole)



Frame size				18AF			
Type				MC-6a/4	MC-9a/4	MC-12a/4	MC-18a/4
	Screw clamp terminal					●	
Number of poles						4pole	
Rated operational voltage (Ue)						690V	
Rated insulation voltage (Ui)						690V	
Rated frequency						50/60Hz	
Rated impulse withstand voltage, Uimp						6kV	
Maximum operating rate in operating cycles per hour(AC1)						1800 operations per hour	
Durability	Mechanical			15 mil. operations			
	Electrical			0.5 mil. operations		0.8 mil. operations	
Current and power	Thermal current	[A]	25	25	25	40	
		[kW]	9	9	9	15	
	AC-1	200/240V	[A]	25	25	25	40
		380/400V	[kW]	17	17	17	27
	500/550V	[A]	25	25	25	40	
		[kW]	21	21	21	35	
	690V	[A]	25	25	25	40	
		[kW]	27	27	27	44	
UL rating (50/60Hz)	Continuous current	[A]	25	25	25	32	
	Single	110~120V	[HP]	0.5	0.5	0.75	1
	Phase	220~240V	[HP]	1.5	1.5	2	3
	Three	200~208V	[HP]	2	2	3	7.5
	Phase	220~240V	[HP]	3	3	5	7.5
		440~480V	[HP]	5	5	7.5	10
		550~600V	[HP]	7.5	7.5	10	15
Size and weight	AC	Weight	[kg]	0.33			
	Control	Size(W×H×D)	[mm]	45×73.5×80.4			
	DC	Weight	[kg]	0.4			
	Control	Size(W×H×D)	[mm]	45×73.5×96.6			
Auxiliary(Standard)				-			
Auxiliary	Side mount			UA-1			
	Front mount			UA-2, UA-4			



	22AF	40AF		85AF			
	MC-22a/4	MC-32a/4	MC-40a/4	MC-50a/4	MC-65a/4	MC-75a/4	MC-85a/4
	●	●		●			
	4pole	4pole		4pole			
	690V	690V		690V			
	690V	690V		1000V			
	50/60Hz	50/60Hz		50/60Hz			
	6kV	6kV		8kV			
	1800 operations	1800 operations per hour		1800 operations per hour			
	15 mil. operations	15 mil. operations		12 mil. operations			
	1 mil. operations	1 mil. operations		1 mil. operations			
	40	50	60	80	100	110	135
	15	18	22	30	37	41	51
	40	50	60	80	100	110	135
	27	35	42	56	70	76	95
	40	50	60	80	100	110	135
	35	43	52	70	88	97	120
	40	50	60	80	100	110	135
	44	55	66	88	110	120	150
	40	50	60	80	100	110	135
	32	45	50	70	80	90	100
	2	2	3	3	5	5	7.5
	3	5	5	7.5	10	15	15
	7.5	7.5	10	10	15	20	25
	7.5	10	10	15	20	25	30
	10	20	25	30	40	50	50
	15	20	25	30	40	50	50
	0.4	0.59		1.2			
	47.2×80×86.8	59×83.5×94.6		91×123.5×117.8			
	0.5	0.7		1.29			
	47.2×80×113.2	59×83.5×121		91×123.5×117.8			
	-	-		-			
	AU-1	AU-1		AU-1			
	UA-2, UA-4	UA-2, UA-4		UA-2, UA-4			

Table of specifications



MC type Magnetic Contactors (4pole)

Frame size				225AF					
Type				MC-100a/4	MC-130a/4	MC-150a/4	MC-185a/4	MC-225a/4	
	Screw clamp terminal			●					
Number of poles				4pole					
Rated operational voltage (Ue)				690V					
Rated insulation voltage (Ui)				1000V					
Rated frequency				50/60Hz					
Rated impulse withstand voltage, Uimp				8kV					
Maximum operating rate in operating cycles per hour(AC1)				1200 operations per hour					
Durability	Mechanical			5 mil. operations					
	Electrical			0.8 mil. operations					
Current and power	Thermal current	[A]		200	250	275	300	350	
		[kW]		57	60	76	87	100	
	AC-1	200/240V	[A]	200	250	275	300	350	
		380/400V	[kW]	106	110	142	165	185	
	500/550V	[A]	200	250	275	300	350		
		[kW]		132	137	180	205	230	
	690V	[A]	200	250	275	300	350		
		[kW]		165	170	225	255	290	
UL rating (50/60Hz)	Continuous current		[A]	200	250	275	300	350	
	Single	110~120V	[HP]	7.5	10	15	15	15	
		Phase	220~240V	[HP]	15	20	25	30	40
	Three	200~208V	[HP]	30	40	40	60	60	
		Phase	220~240V	[HP]	30	40	50	60	75
	440~480V	[HP]	60	75	100	125	150		
		550~600V	[HP]	60	75	100	125	150	
	Size and weight	AC	Weight	[kg]	5.6				
Control			Size(W×H×D)	[mm]	175×203×185				
DC		Weight	[kg]	5.6					
		Control	Size(W×H×D)	[mm]	175×203×185				
Auxiliary(Standard)				2NO2NC					
Auxiliary	Side mount			AU-100, AU-100E					
	Front mount			-					

* - FLA=722A, LRA=5618A

** - FLA=566A, LRA=4495A



400AF			800AF		
MC-265a/4	MC-330a/4	MC-400a/4	MC-500a/4	MC-630a/4	MC-800a/4
●			●		
4pole			4pole		
690V			690V		
1000V			1000V		
50/60Hz			50/60Hz		
8kV			8kV		
1200 operations per hour			1200 operations per hour		
2.5 mil. operations			2.5 mil. operations		
0.5 mil. operations			0.5 mil. operations		
400	500	520	700	900	1050
115	135	160	245	255	310
400	500	520	700	900	1050
215	250	300	450	470	570
400	500	520	700	900	1050
265	315	375	560	590	710
400	500	520	700	900	1050
335	390	470	710	740	900
400	500	520	700	900	1050
400	500	520	700	900	1050
-	-	-	-	-	-
-	-	-	-	-	-
75	100	125	150	200	200
100	100	150	200	250	300
200	200	300	400	500	600*
200	200	300	400	500	600**
9.9 206×243×205			26.3 346×310 ×244		
9.9 206×243×205			26.3 346×310 ×244		
2NO2NC			2NO2NC		
AU-100, AU-100E			AU-100, AU-100E		
-			-		

Table of specifications

Renewable Magnetic Contactor

- Eco-friendly contact material applied (Cd free)
- Type 2 coordination data with MCCB or ACB



Frame size			1260AF			
Type			MCI-900	MCI-1050	MCI-1260	
	Screws clamp terminals			●		
Number of poles	[pole]			3		
Rated operational voltage(Ue)	[Vac]			1000		
Rated insulation voltage(Ui)	[Vac]			1000		
Rated frequency	[Hz]			50/60		
Rated impulse withstand voltage(Uimp)	[kV]			8		
Mechanical operating cycle	[cycles/hour]		600	600	300	
Electrical operating cycle	[cycles/hour]		600	600	300	
Durability	Mechanical	[million]	1	1	0.5	
	Electrical(AC-1@690V)	[million]	0.26	0.26	0.15	
	Electrical(AC-1@400V)	[million]	0.5	0.5	0.2	
Current and Power (IEC)	AC-1 1000V 55/60/70°C	[A]	900/850/700	1050/875/720	1260/1060/900	
	Thermal current	[A]	900	1050	1260	
	Heat dissipation	[W]	100	170	170	
Rated Short-time withstand current(Icw) (IEC 60947)	1s	[A]	7000	7500	8000	
	10s	[A]	6400	7000	7200	
	1min	[A]	3500	3800	4000	
	10min	[A]	1550	1550	2300	
max. breaking capacity(Icd)	400V	[A]	6000	7500	7500	
	690V	[A]	5000	7000	7000	
	1000V	[A]	2000	2500	2500	
Type-2 Coordination (with MCCB or ACB)	[kA]		42kA (Break time: less than 20ms)			
Current and HP (UL)	Thermal current	[A]	900	1050	1260	
	Single phase	110~120V	[HP]	-	-	-
		220~240V	[HP]	-	-	-
	Three phase	200~208V	[HP]	200	200	-
		220~240V	[HP]	250	300	-
		440~480V	[HP]	500	600	-
	550~600V	[HP]	500	600	-	
Weight	[kg]		22.2	22.2	25	
Size(W×H×D) mm]			285 x 310 x 246	285 x 310 x 246	285 x 352 x 246	
Auxiliary(Standard)			2a2b			
Auxiliary	Side mount		AU-100, AU-100E (max.4a4b)			
	Front mount		-			



2650AF		
MCI-1700	MCI-2100	MCI-2650
	●	
	3	
	1000	
	1000	
	50/60	
	8	
	300	
300	300	120
0.5	0.5	0.3
0.05	0.05	0.02
0.05	0.05	0.05
1700/1450/1300	2100/1750/1500	2650/2350/2150
1700	2100	2650
220	350	350
	12000	
	10000	
	5500	
	3000	
9000	12000	12000
8000	8500	8500
3000	3150	3150
42kA (Break time: less than 50ms)		
1700	2100	2650
-	-	-
-	-	-
-	-	-
-	-	-
-	-	-
34.6	34.6	47
431 x 380 x 246	431 x 380 x 246	431 x 392 x 246
2a2b		
AU-100, AU-100E (max.4a4b)		
-		

Type numbering system

Contactors

MC-6a	/	R	/	220V	60Hz	SCREW	1a1b
Rated current		Version		Coil voltage	Frequency		Auxiliary contact
6a 6A		- Standard		AC 220V	60Hz	None	None
⋮		R Reversing		⋮	50Hz	Screw	1a1b
2650a 2650A		4 4pole		DC 24V	50/60HZ	LUG	2a2b
9b 9A							1a
⋮							1b
22b 22A							

Note) See page 22, 23 for details.

Renewable contactors

MCi-900	/	AC 300V	50/60Hz	2a2b
Rated Current		Coil Voltage	Frequency	Auxiliary contact
900 900A		AC 300V	50/60Hz	2a2b
⋮		⋮		
2650 2650A		AC 100~240V		
		DC 100~220V		

Starters

MS-6a	/	R	2H	/	220V	60Hz	1N01NC	/	0.1
Rated current		Contactor version	Relay version		Coil voltage	Frequency	Auxiliary contact		Relay setting current
6a 6A		- Standard	2H Non-differential (2-heater)		AC 220V	60Hz	無		0.1 0.1A
⋮		R Reversing	3H Non-differential (3-heater)		⋮	50Hz	1a1b		⋮
800a 800A			3K Differential		DC 24V		2a2b		800 800A
9b 9A			3D Class 20				1a		
⋮							1b		
22b 22A									

Note) See page 22, 23 for details.

Thermal Overload Relay

MT-12	/	2H	0.1
Rated current		Relay version	Relay setting current
12 12AF		2H Non-differential (2-heater)	0.1 0.1A
32 32AF		⋮	⋮
63 63AF		3H Non-differential (3-heater)	800 800A
95 95AF		⋮	
⋮		3K Differential	
800 800AF		3D Class 20	

Contactor relays

MR	/	4
		Poles
		4 4 Pole
		6 6 Pole
		8 8 Pole

Optional accessories

Auxiliary contact unit

UA1	
Version	
UA-1 AU-100 AU-100E	Side mount
UA-2	Front mount(2P)
UA-4	Front mount(4P)

11	
Contact composition	
11	1NO+1NC
20	2NO
02	2NC
40	4NO
31	3NO+1NC
22	2NO+2NC
13	1NO+3NC
04	4NC

Note) UA-2: 2NO, 1NO1NC, 2NC
 UA-4: 4NO, 3NO1NC, 4NC,
 2NO2NC, 1NO3NC,

Surge absorber

US11		
Composition and voltage		
1	Varistor+RC	AC 24~48V
2	Varistor+RC	AC 100~125V
3	Varistor+RC	AC 200~240V
4	Varistor+RC	DC 24~48V
5	Varistor+RC	DC 100~125V
6	Varistor+RC	DC 200~220V
11	Varistor	AC/DC 24~48V
12	Varistor	AC/DC 100~125V
13	Varistor	AC/DC 200~240V
14	Varistor	AC/DC 380~440V
22	RC	AC 100~125V

Note) See page 82 for details.

Interlock unit	Wire kit for interlocking	Separate mounting unit (For relay)	Remote reset unit (For relay)
UR02	UW32	UZ32	UM
Contact composition	Rated current	Rated current	Cable length
02 2NC	18 18AF	12 12AF	4R 400
00 None	22 22AF	32 32AF	5R 500
	32 40AF	63 63AF	6R 600
	63 65AF	95 95AF	
	95 100AF	150 150AF	



















Environment



Standards	IEC/EN 60947-1, IEC/EN 60947-4-1, UL508, K60947
Certifications	CE, UL, CCC
Rated insulation voltage (Ui)	1000V (6A-22A: 690V, 32A-800A: 1000V)
Rated impulse withstand voltage (Uimp)	8kV (6A-22A: 6kV, 32A-800A: 8kV)
Degree of protection	IP20 (Conforming to IEC60529)
Ambient air temperature	<p>Storage: -30°C ~ +65°C (MCI : -40 ~ +80°C)</p> <p>Operation: -5°C ~ +55°C (AC Type) -5°C ~ +40°C (MT, DC Type) -25°C ~ +60°C (MT refer to Graph) -25°C ~ +55°C (MCI)</p>
Operating altitude	3000m (8900ft)
Operating positions	
Shock resistance (1/2 sine wave =11ms)	Opened: 8G(MC-2650a / MCI-2650 : 5G) Closed: 10G(MC-2650a / MCI-2650 : 5G)
Vibration resistance (Conforming to IEC68-2-6) (5...300 Hz)	Opened: 2G(MC-2650a / MCI-2650 : 1G) Closed: 4G(MC-2650a / MCI-2650 : 1G)
Flame resistance	Conforming to UL 94: V0 Conforming to IEC 695-2-1: 960°C

Connections

Metasol MS

Frame	Wire type	Main terminal size							Torque		
			(AWG / mm ²)						mm(max)	[lb-in]	[Nm]
MC-6a/9a		M3.5	18-10/1-4	18-10 / 1-4	18-10 / 1-4			8.3	10	1.13	12
MC-12a			16-10/1.5-4	16-10 / 1.5-4	16-10 / 1.5-4						
MC-18a			16-10/1.5-6	16-10 / 1.5-6	16-10 / 1.5-6						
MC-9b		M4	18-10/1-4	18-10 / 1-4	18-10 / 1-4			9.6	20	2.25	23
MC-12b			16-10/1.5-6	16-10 / 1.5-6	16-10 / 1.5-6						
MC-18b			16-10/1.5-6	16-10 / 1.5-6	16-10 / 1.5-6						
MC-22b			14-8/2.5-10	14-8 / 2.5-10	14-8 / 2.5-10						
MC-32a		M5	-	12-6 / 2.5-16	12-6 / 2.5-16			12.8	35	4	41
MC-40a			-	12-6 / 2.5-16	12-6 / 2.5-16						
MC-50a		M6	-	10-3 / 4-35	10-3 / 4-35			14	35	4	41
MC-65a			-	10-2 / 4-35	10-2 / 4-35						
MC-75a		M8	-	10-1 / 6-50	10-1 / 6-50			17	45	5.1	52
MC-85a			-	10-1/0 / 6-50	10-1/0 / 6-50						
MC-100a			-	10-2/0 / 6-70	10-2/0 / 6-70						
MC-130a		M8	-	8-3/0 / 10-95	8-3/0 / 10-95			24	80	9.1	93
MC-150a			-	8-250kcmil / 10-120	8-250kcmil / 10-120						
MC-6-150a Aux./Coil		M4	20-14 / 0.5-2.5	18-12 / 0.75-2.5	18-12 / 0.75-2.5			7.6	10	1.13	12
MC-185a		M10	-	3-350kcmil / 35-185	3-350kcmil / 35-185			25	130	14.7	150
MC-225a			-	3-400kcmil / 35-185	3-400kcmil / 35-185						
MC-265a		M12	-	2-500kcmil / 35-240	2-500kcmil / 35-240			30	200	22.6	230
MC-330a			-	2-250kcmil x 2 / 35-150 x 2	2-250kcmil x 2 / 35-150 x 2						
MC-400a			-	2-350kcmil x 2 / 35-185 x 2	2-350kcmil x 2 / 35-185 x 2						
MC-500a		M16	-	4/0-300kcmil x 3 / 95-240 x 2	4/0-300kcmil x 3 / 95-240 x 2			40	500	56.5	576
MC-630a/MCi-900			-	95-60 x 5 x 2	95-60 x 5 x 2						
MC-800a/MCi-1050			-	95-80 x 5 x 2	95-80 x 5 x 2						
MC-185-800a/MCi-1050 Aux./Coil		M4	16-10 / 1.25~5.5	16-10 / 1.25~5.5	16-10 / 1.25~5.5			7.6	15	1.75	18
MC-1260a/MCi-1260		M12	-	50mm×10mm×2ea	-			-	200	22.6	230
MC-1400a		M12	-	100mm×5mm×2ea 100mm×5mm×3ea 100mm×5mm×4ea 100mm×10mm×3ea	-			-	200	22.6	230
MC-1700a/MCi-1700											
MC-2100a/MCi-2100											
MC-2650a/MCi-2650											

Control coil characteristics (3pole)



Frame size			18AF	22AF	40AF	65AF	100AF	150AF(A)	
Type			MC-6a	MC-9b	MC-32a	MC-50a	MC-75a	MC-130a	
			MC-9a	MC-12b	MC-40a	MC-65a	MC-85a	MC-150a	
			MC-12a	MC-18b		MD-30a	MC-100a		
			MC-18a	MC-22b			MD-60a		
			MR-4, 6, 8				MD-100a		
AC coil									
Control voltage	[Uc]							48, 110~120, 220~240, 300, 380~440, 500V	
	50Hz	[V]	24, 32, 36, 42, 48, 80, 100, 110, 120, 220, 230, 240, 380, 400, 415, 440, 500, 550V						
	60Hz	[V]	24, 48, 110, 120, 200, 208, 220, 230, 240, 277, 380, 440, 480, 600V						
Voltage limit	[Uc]		85 ~110%						
Coil consumption at 20°C									
AC 220V	Inrush	[VA]	70	70	90	110	240	110	
60Hz	Holding	[VA]	9	9	9	13	17	18	
Heat dissipation			[W]	2.3	2.3	2.7	2.8	5.4	2.7
Operating time									
	Closing	[ms]	15 ... 30	15 ... 30	15 ... 30	15 ... 30	15 ... 30	20 ... 40	
	Opening	[ms]	4 ... 19	4 ... 19	4 ... 19	4 ... 19	10 ... 30	50 ... 7	
DC coil									
Control voltage	[Uc]		12, 20, 24, 30, 48, 60, 80, 100, 110, 125, 200, 220, 250V					24, 48	
Voltage limit	[Uc]		85~110%						
Coil consumption at 20°C									
DC 110V	Inrush	[W]	6	6	9	9	18	280 <i>Note 3)</i>	
	Holding	[W]	6	6	9	9	18	7.5	
Time constant (L/R)			[ms]	28	28	28	65	75	
Operating time									
	Closing	[ms]	40 ... 70 <i>Note 2)</i>	40 ... 70 <i>Note 2)</i>	50 ... 65	50 ... 65	100 ... 120	70 ... 80	
	Opening	[ms]	4 ... 19	4 ... 19	4 ... 19	4 ... 19	10 ... 25	60 ... 70	

Note 1. Either semi-electronic coil(A) or electronic coil(B) can be chosen for MC-130a and MC-150a
Note 2. The operation time may increase up to 80ms when re-supply after the ON state continues.
Note 3. MC-150AF is based on DC24V

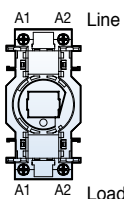

Note) A1(A2) in line side is internally connected to A1(A2) in load side.



Frame size	150AF(B)	225AF	400AF	800AF	1260AF	2650AF
Type	MC-130a MC-150a	MC-185a MC-225a	MC-265a MC-330a MC-400a	MC-500a MC-630a MC-800a MCI-900 MCI-1050	MC-1260a MCI-1260	MC-1400a MC-1700a MC-2100a MC-2650a MCI-1700 MCI-2100 MCI-2650
AC/DC common coil						
Control voltage [Uc]						
AC/DC	AC 24	24/24	DC 24	-	-	-
AC/DC	24~48/24~48	48/48	-	100/100	-	-
AC/DC	100~240/100~220	100~240/100~220	100~240/100~220	200/200	100~240/100~220	100~240/100~220
AC or DC	DC 70~110	AC 300	AC 300	AC 300	-	-
AC or DC	DC 110	AC 400	AC 400	AC 400	-	-
AC or DC	-	AC 500	AC 500	AC 500	-	-
Voltage limit [Uc]	85~110% <i>Note 1)</i>					
Coil consumption at 20°C <i>Note 2)</i>						
AC 220V Inrush [VA]	320	380	571	1000	1500	2500
50/60Hz Holding [VA]	10	11.6	14	29	24	50
Heat dissipation [W]	4.5	4.7	5	7.8	7.8	8.7
Operating time						
Closing [ms]	70	70	55	75	75	80
Opening [ms]	70	70	55	75	75	70

- Note 1)* Voltage limit for DC 24V coil is 75~110%.
Note 2) Operating time for DC 24V coil is 90ms.
 3. Either semi-electronic coil(A) or electronic coil(B) can be chosen for MC-130a and MC-150a
 4. Please check the details page for each AF range

Control coil characteristics (4pole)



Frame size			18AF	22AF	40AF	85AF
Type			MC-6a/4P MC-9a/4P MC-12a/4P MC-18a/4P	MC-22a/4P	MC-32a/4P MC-40a/4P	MC-50a/4P MC-65a/4P MC-75a/4P MC-85a/4P
AC coil						
Control voltage	[Uc]					
	50Hz	[V]	24, 32, 42, 48, 80, 100, 110, 220, 230, 240, 380, 400, 500, 550	24, 32, 42, 48, 65, 80, 100, 110, 220, 230, 240, 380, 400, 415, 500, 550, 240(wide)		24, 48, 100, 110, 200, 220, 230, 240, 380, 400, 415, 440, 500, 550, 240(wide)
	60Hz	[V]	24, 48, 100, 110, 120, 200, 208, 220, 230, 240, 277, 380, 480, 600	24, 48, 110, 120, 208, 220, 240, 277, 380, 440, 480, 600		24, 48, 110, 120, 208, 220, 230, 240, 277, 380, 440, 480, 600
	50/60Hz	[V]	24, 48, 100, 110, 120, 200, 220, 230, 20, 380, 415, 440, 500, 550	24, 48, 100, 110, 120, 200, 220, 230, 240, 380, 415, 440, 500, 550		24, 48, 110, 120, 220, 230, 240, 380, 415, 440, 500, 550
Voltage limit			85~110%			
Coil consumption at 20°C						
AC 220V	Inrush	[VA]	70	95	95	220
60Hz	Holding	[VA]	9	9	9	17
Heat dissipation		[W]	2.3	2	2	5
Operating time	Closing	[ms]	15...30	10~17	10~17	16~25
	Opening	[ms]	4...9	6~9	6~9	8~15
DC coil						
Control voltage	[Uc]		12, 20, 24, 48, 60, 80, 100, 110, 125, 200, 220, 250			
Voltage limit			85~110%			
Coil consumption at 20°C						
DC 100V	Inrush	[W]	6	9	9	460
(18AF: DC110V)	Holding	[W]	6	9	9	6
Time constant (L/R)		[ms]	28	50	50	-
Operating time	Closing	[ms]	40...60	45~55	45~55	20~30
	Opening	[ms]	4...19	8~15	8~15	13~20



Frame size			225AF	400AF	800AF
Type			MC-100a/4P MC-130a/4P MC-150a/4P MC-185a/4P MC-225a/4P	MC-265a/4P MC-330a/4P MC-400a/4P	MC-500a/4P MC-630a/4P MC-800a/4P
AC/DC common coil					
Control voltage	[Uc]				
	[AC/DC]		24/24	24(DC Only)	-
	[AC/DC]		48/48	-	100/100
	[AC/DC]		100~240/100~220	100~240/100~220	200/200
	[AC]		300	300	300
	[AC]		400	400	400
	[AC]		500	500	500
Voltage limit			85~110% <i>Note 1)</i>		
Coil consumption at 20°C <i>Note 2)</i>					
AC 220V 50/60Hz	Inrush	[VA]	380	571	1000
	Holding	[VA]	11.6	14	29
Heat dissipation		[W]	4.7	5	7.8
Operating time	Closing	[ms]	70	55	75
	Opening	[ms]	70	55	75

Note 1) Voltage limit for DC 24V coil is 75~110%.
Note 2) Operating time for DC 24V coil is 90ms.

Marking

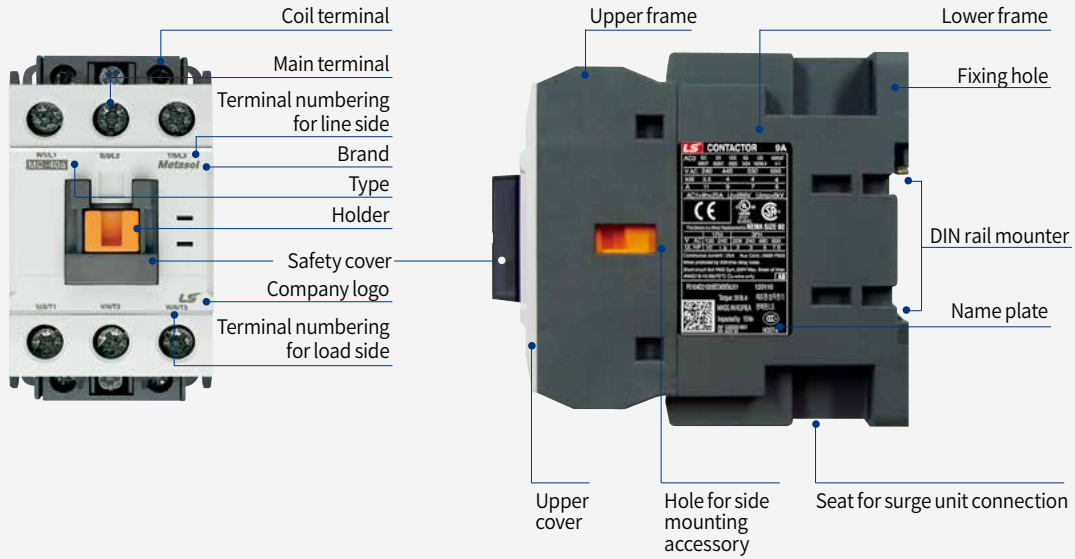

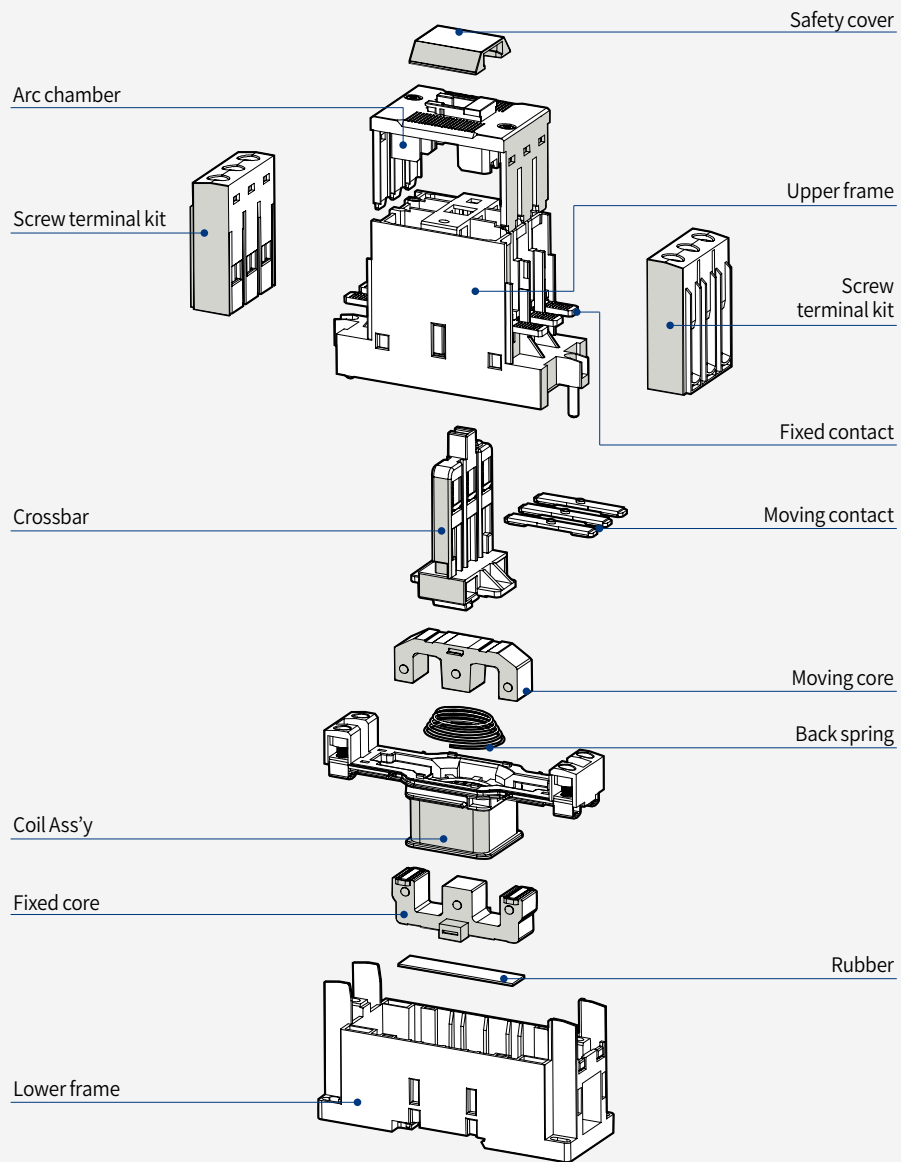

Contactors

Description 18AF

- 3-pole(NO) main contact
- Finger proof design
- DIN rail or screw mountable
- AC or DC control in different physical size
- Front/side mountable accessories available
- Direct mountable overload relay available rating
- 1NO or 1NC Auxiliary contact built-in as standard.
- Degree of protection: IP20

Rating



MC-18a

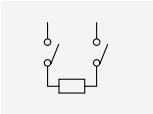

2pole for DC contact

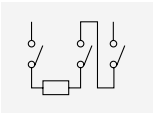

3pole for DC contact

Contactor type			MC-6a		MC-9a		MC-12a		MC-18a		
			kW	A	kW	A	kW	A	kW	A	
AC duty	AC3	200/240V	2.2	9	2.5	11	3.5	13	4.5	18	
		380/440V	3	7	4	9	5.5	12	7.5	18	
		500/550V	3	6	4	7	7.5	12	7.5	13	
		690V	3	4	4	5	7.5	9	7.5	9	
	AC4	200/240V	1.5	7	1.5	8	2.2	11	3.7	16	
		380/440V	2.2	5	2.2	6	4	9	4	11	
	AC1		-	25	-	25	-	25	-	32	
DC1 duty (L/R=1ms)	2-pole in series	24V	-	10	-	10	-	12	-	18	
		48V	-	10	-	10	-	12	-	18	
		110V	-	6	-	6	-	10	-	13	
	3-pole in series	24V	-	10	-	10	-	12	-	18	
		48V	-	10	-	10	-	12	-	18	
		110V	-	8	-	8	-	12	-	18	
	DC3, 4 duty (L/R=15ms)	2-pole in series	24V	-	8	-	8	-	12	-	12
			48V	-	4	-	4	-	6	-	6
			110V	-	2.5	-	2.5	-	4	-	4
3-pole in series		24V	-	8	-	8	-	12	-	12	
		48V	-	6	-	6	-	10	-	10	
		110V	-	4	-	4	-	8	-	8	
Directly mountable overload relay			MT-12								
Conductor size (Solid, stranded) (the max. number of conducts: 2)			AWG	18~10		16~10		16~8		14~8	
			mm ²	1~4		1.5~4		1.5~10		2.5~10	
Conductor type			65/75°C Cu-wire only								



Coil voltage

AC	50Hz	24, 32, 36, 42, 48, 80, 100, 110, 120, 220, 230, 240, 380, 400, 415, 440, 500, 550V
	60Hz	24, 48, 110, 120, 200, 208, 220, 230, 240, 277, 380, 440, 480, 600V
DC		12, 20, 24, 30, 48, 60, 80, 100, 110, 125, 200, 220, 250V

Certification

- CE(IEC)
- UL508
- CCC

* Please be cautious for wiring control power cable, especially “+” (Positive) and “-” (Negative) polarity should be correctly considered.

Accessories

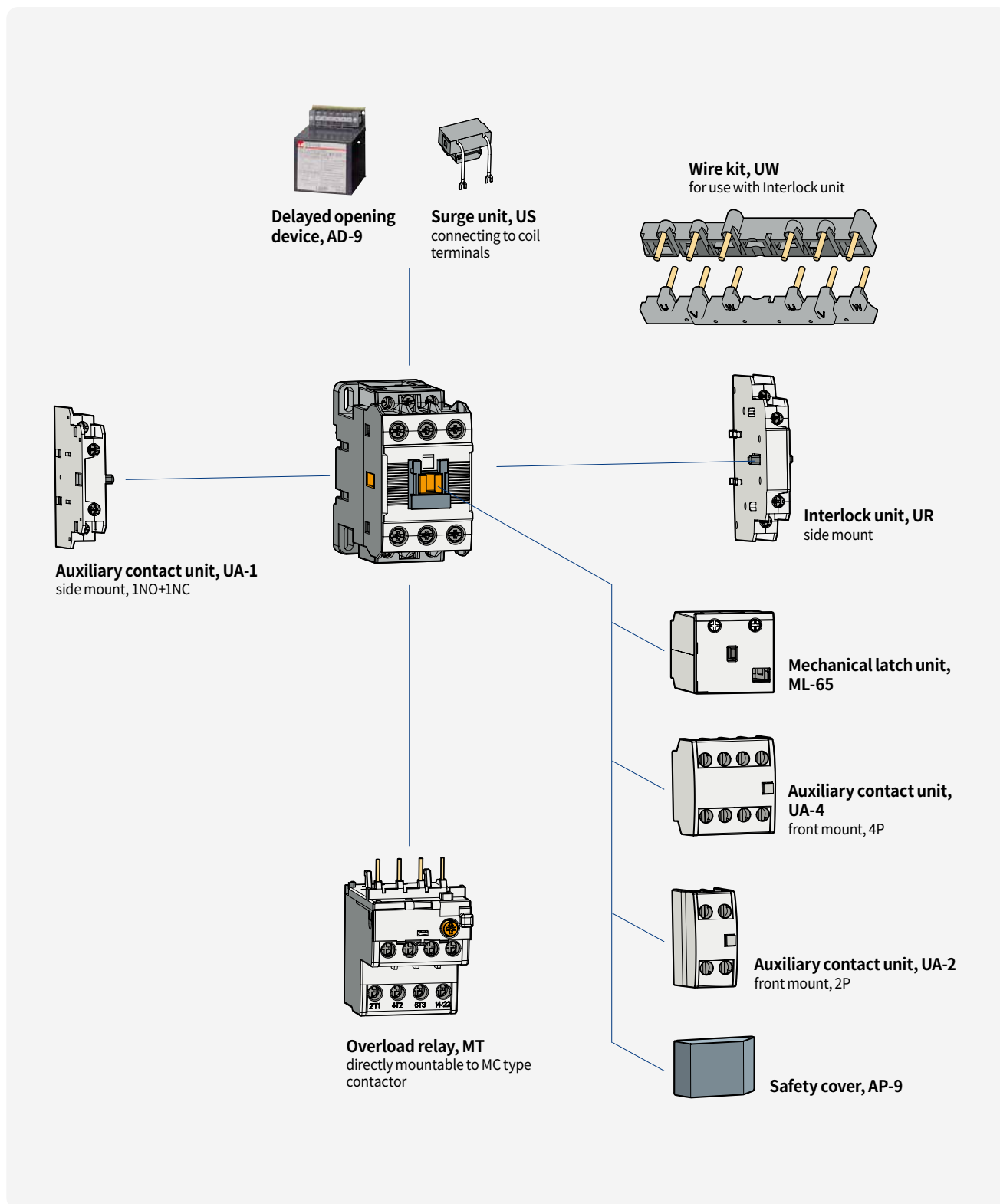

Contactors

Description 22AF

- 3-pole(NO) main contact
- Finger proof design
- DIN rail or screw mountable
- AC or DC control in different physical size
- Front/side mountable accessories available
- Direct mountable overload relay available rating
- 1NO1NC Auxiliary contact built-in as standard.
- UA-1 is available on only left side
- Degree of protection: IP20



MC-22b

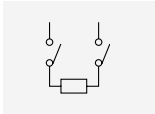

2pole for DC contact

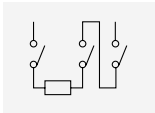

3pole for DC contact

Rating

Contactor type			MC-9b		MC-12b		MC-18b		MC-22b			
			kW	A	kW	A	kW	A	kW	A		
AC duty	AC3	200/240V	2.5	11	3.5	13	4.5	18	5.5	22		
		380/440V	4	9	5.5	12	7.5	18	11	22		
		500/550V	4	7	7.5	12	7.5	13	15	20		
		690V	4	6	7.5	9	7.5	9	15	18		
	AC4	200/240V	1.5	8	2.2	11	3.7	16	3.7	18		
		380/440V	2.2	6	4	9	4	11	5.5	13		
DC1 duty (L/R=1ms)	2-pole in series	24V	-	25	-	27	-	40	-	45		
		48V	-	10	-	12	-	18	-	20		
		110V	-	6	-	10	-	13	-	15		
	3-pole in series	24V	-	10	-	12	-	18	-	20		
		48V	-	10	-	12	-	18	-	20		
		110V	-	8	-	12	-	18	-	20		
		DC3, 4 duty (L/R=15ms)	2-pole in series	24V	-	8	-	12	-	12	-	20
				48V	-	4	-	6	-	6	-	15
				110V	-	2.5	-	4	-	4	-	8
	3-pole in series	24V	-	8	-	12	-	12	-	20		
		48V	-	6	-	10	-	10	-	20		
		110V	-	4	-	8	-	8	-	15		
Directly mountable overload relay			MT-32									
Conductor size (Solid, stranded) (the max. number of conducts: 2)		AWG	16~10		16~8		14~8		14~8			
		mm ²	1.5~4		1.5~10		2.5~10		2.5~10			
Conductor type			65/75°C Cu-wire only									



Coil voltage

AC	50Hz	24, 32, 36, 42, 48, 80, 100, 110, 120, 220, 230, 240, 380, 400, 415, 440, 500, 550V
	60Hz	24, 48, 110, 120, 200, 208, 220, 230, 240, 277, 380, 440, 480, 600V
DC		12, 20, 24, 30, 48, 60, 80, 100, 110, 125, 200, 220, 250V

Certification

- CE(IEC)
- UL508
- CCC

* Please be cautious for wiring control power cable, especially “+” (Positive) and “-” (Negative) polarity should be correctly considered.

Accessories

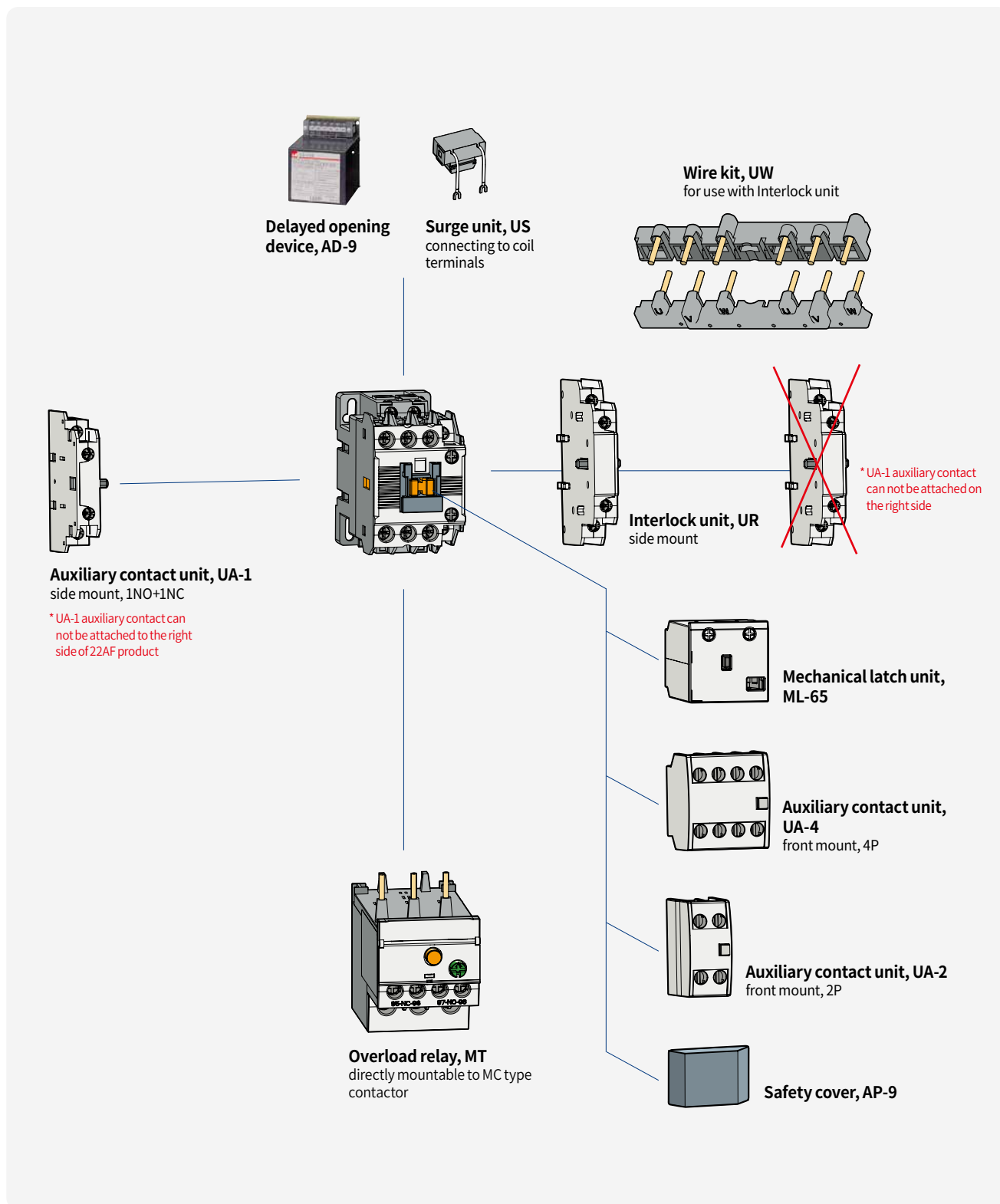

Contactors

Description 40AF

- 3-pole(NO) main contact
- Finger proof design
- DIN rail or screw mountable
- AC or DC control in different physical size
- Front/side mountable accessories available
- Direct mountable overload relay available rating
- 2NO2NC Auxiliary contact built-in is possible as standard
- Degree of protection: IP20



MC-40a

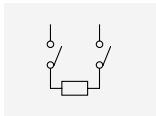

2pole for DC contact

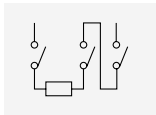

3pole for DC contact

Rating

Contactor type			MC-32a		MC-40a	
			kW	A	kW	A
AC duty	AC3	200/240V	7.5	32	11	40
		380/440V	15	32	18.5	40
		500/550V	18.5	28	22	32
		690V	18.5	20	22	23
		1000V	22	17	22	17
	AC4	200/240V	4.5	20	5.5	25
		380/440V	7.5	17	11	24
	AC1		-	55	-	60
	DC1 (L/R=1ms)	2-pole in series	24V	-	25	-
48V			-	25	-	35
110V			-	25	-	25
3-pole in series		24V	-	25	-	35
		48V	-	25	-	35
		110V	-	25	-	35
DC3, 4 (L/R=15ms)	2-pole in series	24V	-	25	-	35
		48V	-	20	-	20
		110V	-	10	-	10
	3-pole in series	24V	-	25	-	35
		48V	-	25	-	30
		110V	-	20	-	20
Directly mountable overload relay			MT-32			
Conductor size (Solid, stranded) (the max. number of conducts: 2)	AWG		12~8		8~6	
	mm ²		2.5~10		10~16	
Conductor type			65/75°C Cu-wire only			



Coil voltage

AC	50Hz	24, 32, 36, 42, 48, 80, 100, 110, 120, 220, 230, 240, 380, 400, 415, 440, 500, 550V
	60Hz	24, 48, 110, 120, 200, 208, 220, 230, 240, 277, 380, 440, 480, 600V
DC		12, 20, 24, 48, 60, 80, 100, 110, 125, 200, 220, 250V

Certification

- CE(IEC)
- UL508
- CCC

Accessories

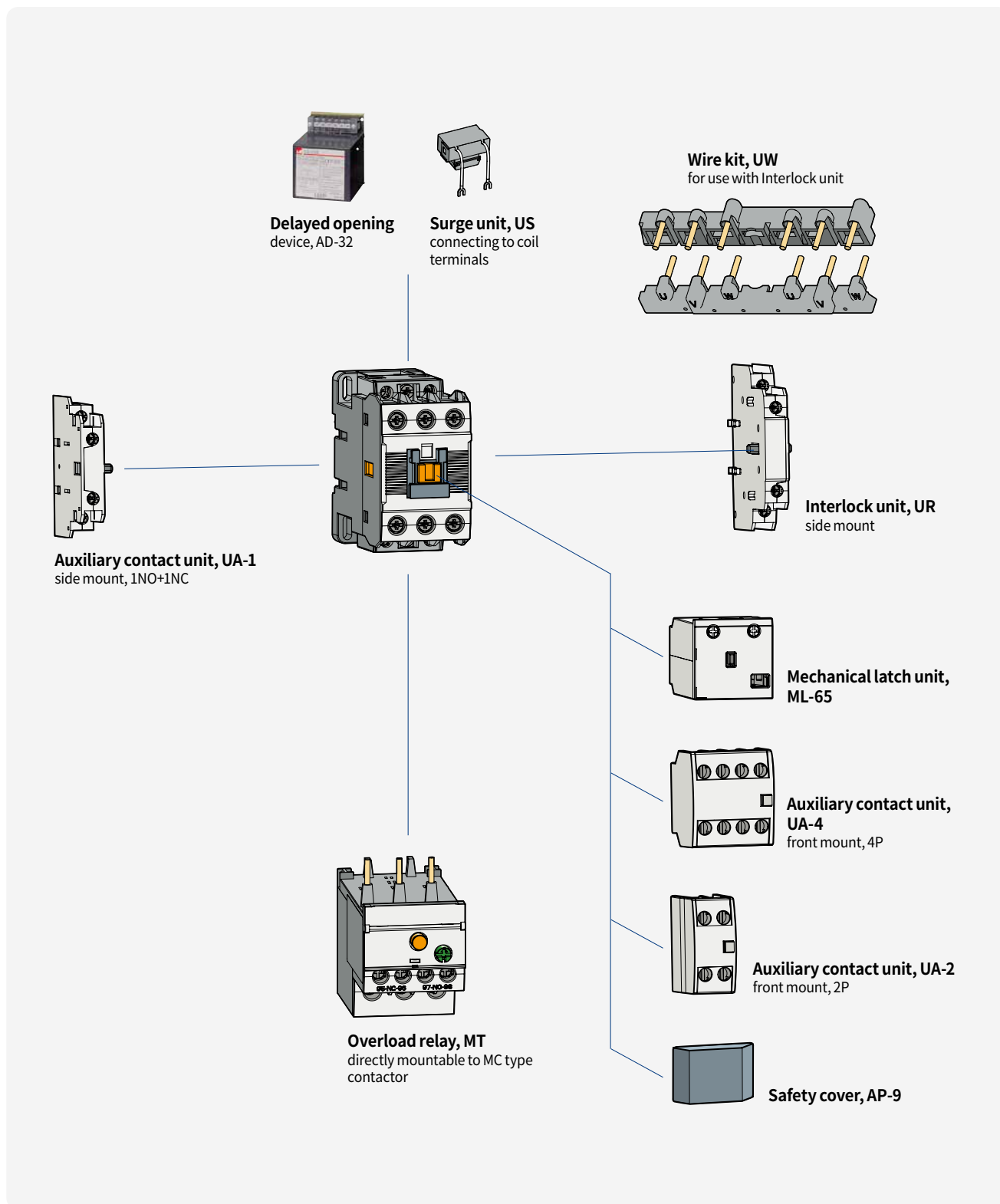

Contactors

Description 65AF

- 3-pole(NO) main contact
- Finger proof design
- DIN rail or screw mountable
- Both screw and Box terminal (lug) type are available
- AC or DC control in different physical size
- Front/side mountable accessories available
- Direct mountable overload relay available rating
- 2NO2NC Auxiliary contact built-in is possible as standard
- Degree of protection: IP20

Rating



MC-65a

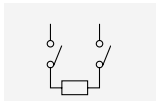

2pole for DC contact

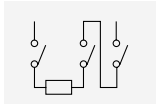

3pole for DC contact

Contactor type			MC-50a		MC-65a		
			kW	A	kW	A	
AC duty	AC3	200/240V	15	55	18.5	65	
		380/440V	22	50	30	65	
		500/550V	30	43	33	60	
		690V	30	28	33	35	
		1000V	30	23	30	23	
	AC4	200/240V	7.5	35	11	50	
		380/440V	15	32	22	47	
	AC1		-	100	-	115	
	DC1 duty (L/R=1ms)	2-pole in series	24V	-	50	-	50
			48V	-	40	-	40
110V			-	35	-	35	
3-pole in series		24V	-	50	-	65	
		48V	-	50	-	65	
		110V	-	50	-	65	
DC3, 4 duty (L/R=15ms)	2-pole in series	24V	-	45	-	45	
		48V	-	25	-	25	
		110V	-	15	-	15	
	3-pole in series	24V	-	50	-	50	
		48V	-	35	-	35	
		110V	-	30	-	30	
Directly mountable overload relay			MT-63				
Conductor size (Solid, stranded) (the max. number of conducts: 2)		AWG	10~4		8~3		
		mm ²	6~25		10~35		
Conductor type			65/75°C Cu-wire only				



Coil voltage

AC	50Hz	24, 32, 36, 42, 48, 80, 100, 110, 120, 220, 230, 240, 380, 400, 415, 440, 500, 550V
	60Hz	24, 48, 110, 120, 200, 208, 220, 230, 240, 277, 380, 440, 480, 600V
DC		12, 20, 24, 48, 60, 80, 100, 110, 125, 200, 220, 250V

Certification

- CE(IEC)
- UL508
- CCC

Accessories

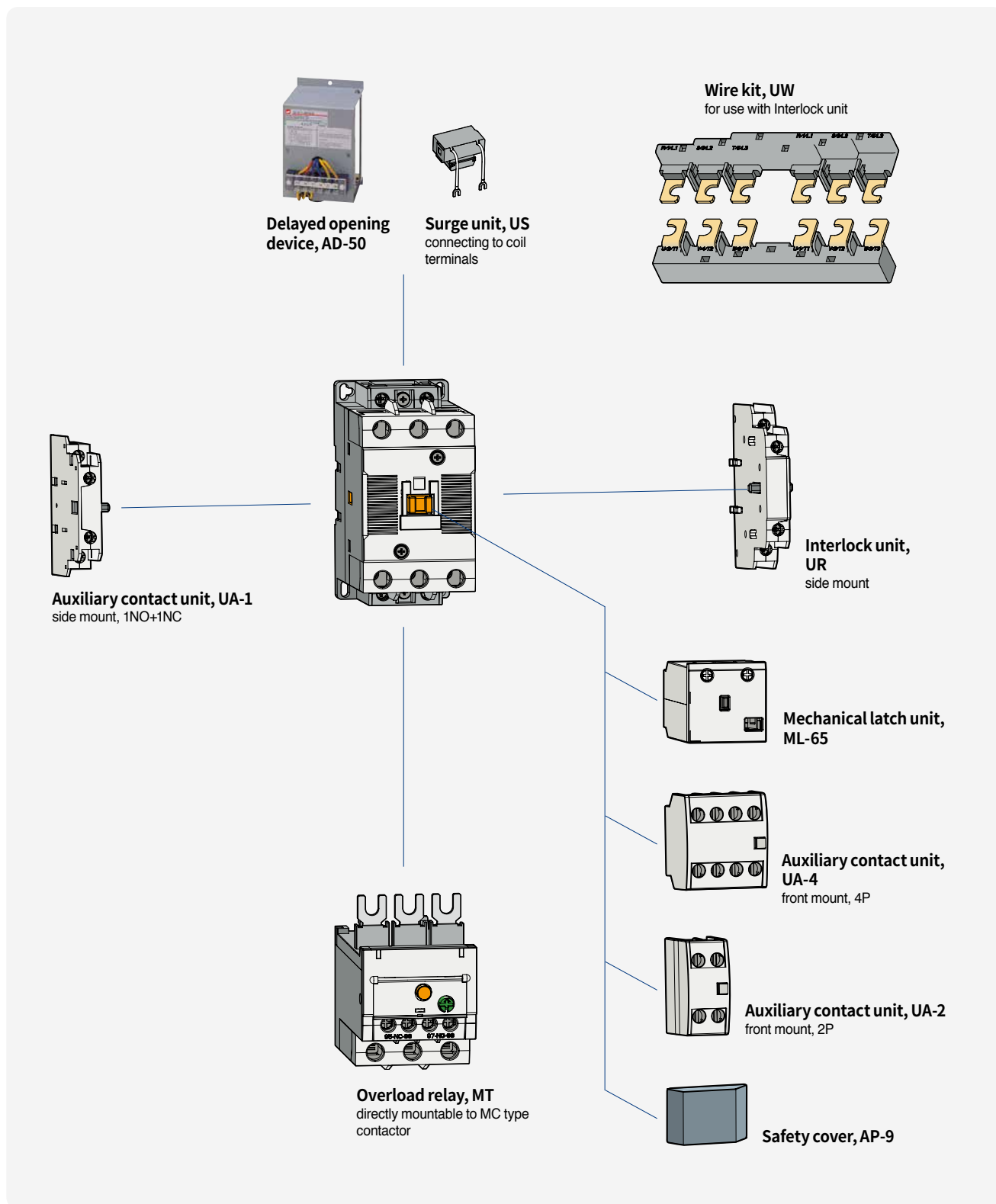

Contactors

Description 100AF

- 3-pole(NO) main contact
- Finger proof design
- DIN rail or screw mountable
- Both screw and Box terminal (lug) type are available
- AC or DC control in different physical size
- Front/side mountable accessories available
- Direct mountable overload relay available rating
- 2NO2NC Auxiliary contact built-in is possible as standard
- Degree of protection: IP20

Rating



MC-100a

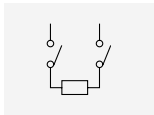

2pole for DC contact

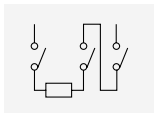

3pole for DC contact

Contactor type			MC-75a		MC-85a		MC-100a		
			kW	A	kW	A	kW	A	
AC duty	AC3	200/240V	22	75	25	85	30	105	
		380/440V	37	75	45	85	55	105	
		500/550V	37	64	45	75	55	85	
		690V	37	42	45	45	55	65	
		1000V	37	28	37	28	37	28	
	AC4	200/240V	13	55	15	65	19	80	
		380/440V	25	52	30	62	37	75	
	AC1		-	125	-	135	-	160	
	DC1 duty (L/R=1ms)	2-pole in series	24V	-	75	-	80	-	100
			48V	-	65	-	65	-	100
110V			-	50	-	50	-	80	
3-pole in series		24V	-	75	-	80	-	100	
		48V	-	75	-	80	-	100	
		110V	-	75	-	80	-	100	
DC3, 4 duty (L/R=15ms)	2-pole in series	24V	-	65	-	65	-	100	
		48V	-	40	-	40	-	60	
		110V	-	20	-	20	-	40	
	3-pole in series	24V	-	80	-	80	-	100	
		48V	-	60	-	60	-	90	
		110V	-	50	-	50	-	80	
Directly mountable overload relay			MT-95						
Conductor size (Solid, stranded) (the max. number of conducts: 2)		AWG	8-2		8-0		8-00		
		mm ²	10-35		10-50		10-70		
Conductor type			65/75°C Cu-wire only						



Coil voltage

AC	50Hz	24, 32, 36, 42, 48, 80, 100, 110, 120, 220, 230, 240, 380, 400, 415, 440, 500, 550V
	60Hz	24, 48, 110, 120, 200, 208, 220, 230, 240, 277, 380, 440, 480, 600V
DC		12, 20, 24, 48, 60, 80, 100, 110, 125, 200, 220, 250V

Certification

- CE(IEC)
- UL508
- CCC

Accessories

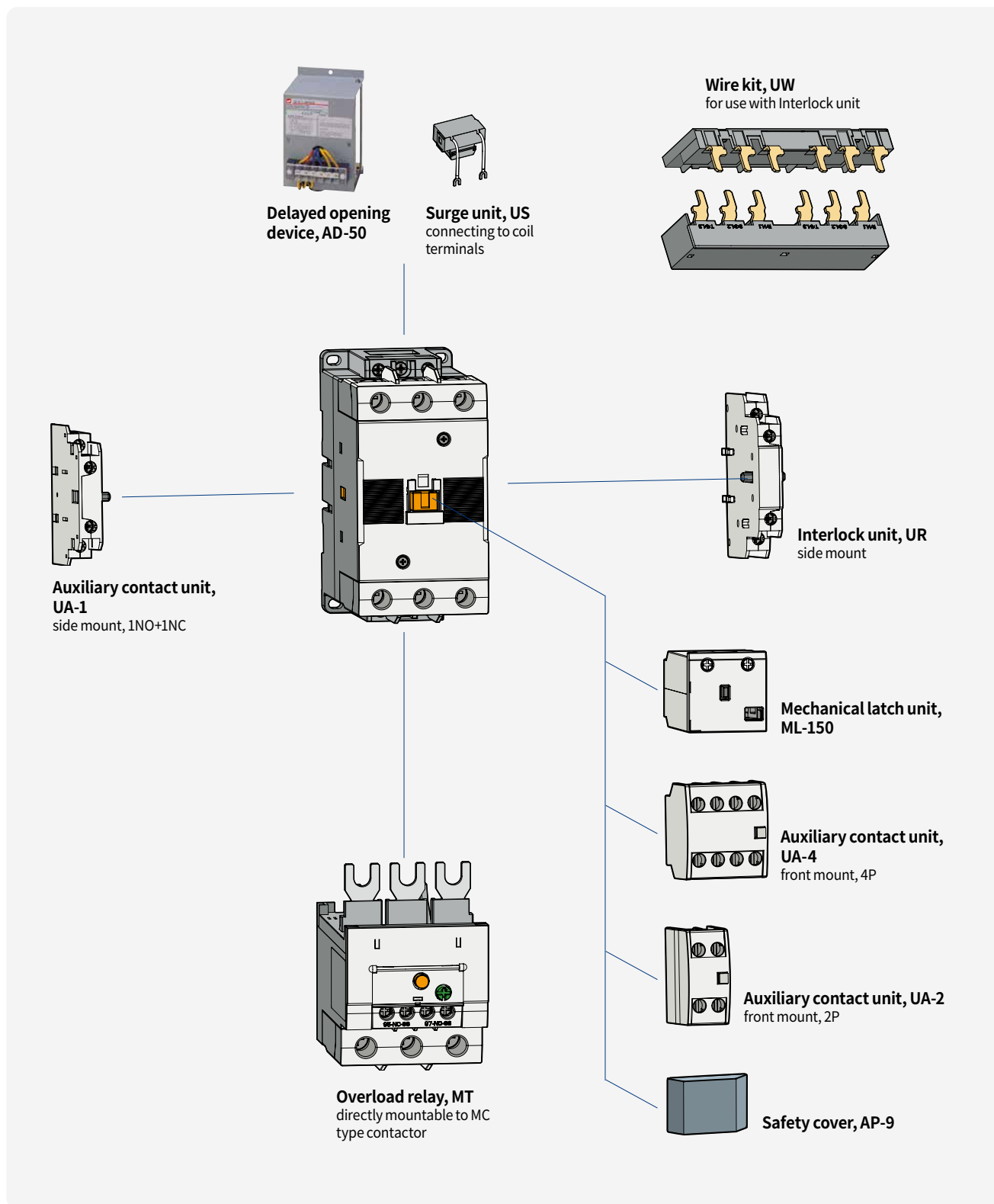

Contactors

Description 150AF

- 3-pole(NO) main contact
- Finger proof design
- DIN rail or screw mountable
- Both screw and Box terminal (lug) type are available
- AC or DC control in the same physical size
- Front/side mountable accessories available
- Direct mountable overload relay available
- 2NO2NC Auxiliary contact built-in is possible as standard
- Degree of protection: IP20

Rating



MC-150a

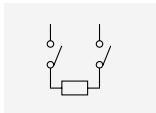

2pole for DC contact

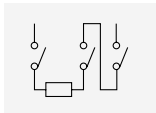

3pole for DC contact

Contactor type			MC-130a		MC-150a	
			kW	A	kW	A
AC duty	AC3	200/240V	37	130	45	150
		380/440V	60	130	75	150
		500/550V	60	90	70	100
		690V	55	60	55	60
		1000V	75	50	75	50
	AC4	200/240V	22	93	30	120
		380/440V	45	90	55	110
	AC1		-	200	-	250
DC1 duty (L/R=1ms)	2-pole in series	24V	-	120	-	150
		48V	-	100	-	120
		110V	-	80	-	100
	3-pole in series	24V	-	120	-	150
		48V	-	120	-	150
		110V	-	100	-	150
DC3, 4 duty (L/R=15ms)	2-pole in series	24V	-	120	-	150
		48V	-	60	-	100
		110V	-	40	-	80
	3-pole in series	24V	-	120	-	150
		48V	-	90	-	130
		110V	-	80	-	120
Directly mountable overload relay			MT-150			
Conductor size (Solid, stranded) (the max. number of conducts: 2)	AWG		3~00		3~4/0	
	mm ²		35~70		35~95	
Conductor type			65/75°C Cu-wire only			



Coil voltage

AC / DC	100~240 / 100~220 / 24~48
AC 50/60Hz	24, 48, 100~240, 110~120, 220~240, 300, 380~440, 500V
DC	24, 48, 70~110, 100~220, 110, 220V

Certification
<ul style="list-style-type: none"> • CE(IEC) • UL508 • CCC

Accessories

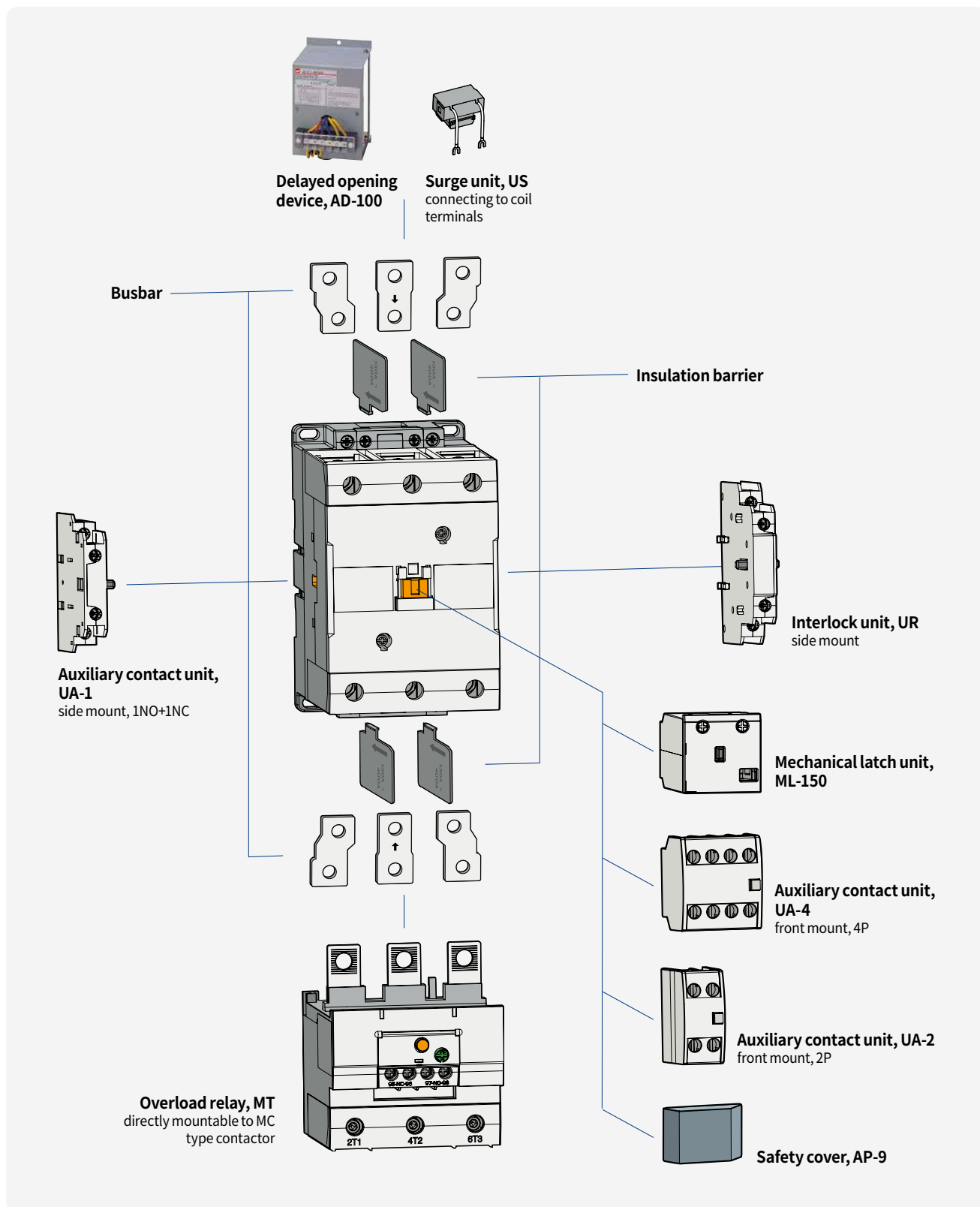

Description 225AF

- 3-pole main contact
- AC/DC common use coil built
- Wide coil operation voltage
- Screw mountable
- 2NO+2NC Auxiliary contacts built-in as standard
- Top/side mountable accessories available
- Direct mountable overload relays available
- Degree of protection: IP00



MC-225a

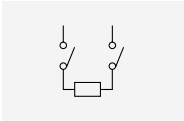

2pole for DC contact

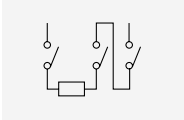

3pole for DC contact

Rating

Contactor type			MC-185a		MC-225a	
			kW	A	kW	A
AC duty	AC3	200/240V	55	185	75	225
		380/440V	90	185	132	225
		500/550V	110	180	132	200
		690V	110	120	140	150
		1000V	132	90	132	90
	AC4	200/240V	37	150	45	180
		380/440V	75	150	90	180
	AC1		-	300	-	350
	DC1 duty (L/R=1ms)	2-pole in series	24V	-	180	-
48V			-	180	-	180
110V			-	150	-	150
3-pole in series		24V	-	180	-	220
		48V	-	180	-	220
		110V	-	180	-	220
DC3, 4 duty (L/R=15ms)	2-pole in series	24V	-	180	-	220
		48V	-	150	-	150
		110V	-	120	-	120
	3-pole in series	24V	-	180	-	220
		48V	-	180	-	220
		110V	-	150	-	150
Directly mountable overload relay			MT-225			
Conductor size (Solid, stranded) (The max. number of conducts: 2)	AWG	1~4/0		0~300		
	mm ²	50~95		50~150		
Conductor type			75°C Cu stranded wire			



Coil voltage, AC/DC common

Nominal(ordering) voltage	AC 50/60Hz	DC
24V	24 - 25V	24V
48V	48 - 50V	48V
100/200V	100 - 240V	100 - 220V
300V	265 - 347V	-
400V	380 - 450V	-
500V	440 - 575V	-

Certification
<ul style="list-style-type: none"> • CE(IEC) • UL508 • CCC

Accessories

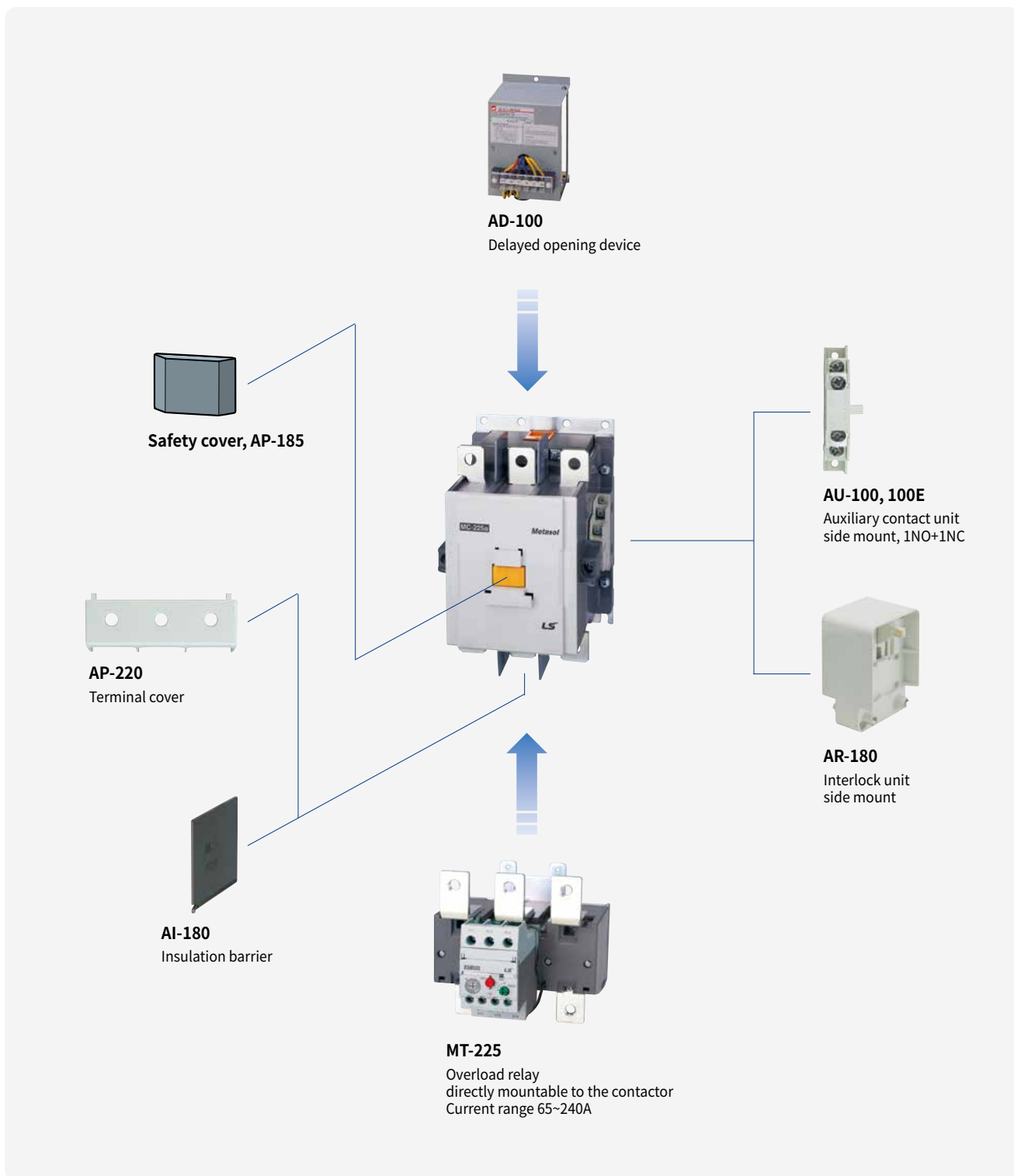

Contactors

Description 400AF

- 3-pole main contact
- AC/DC common use coil built
- Wide coil operation voltage
- Screw mountable
- 2NO+2NC Auxiliary contacts built-in as standard
- Side mountable accessories available
- Degree of protection: IP00



MC-400a

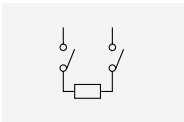

2pole for DC contact

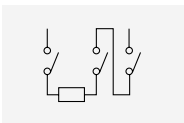

3pole for DC contact

Rating

Contactor type			MC-265a		MC-330a		MC-400a	
			kW	A	kW	A	kW	A
AC duty	AC3	200/240V	80	265	90	330	125	400
		380/440V	147	265	160	330	200	400
		500/550V	147	225	160	280	225	350
		690V	160	185	200	220	250	300
		1000V	147	105	147	105	147	105
	AC4	200/240V	50	200	55	220	75	300
		380/440V	102	200	110	220	150	300
		AC1	-	400	-	500	-	520
	DC1 duty (L/R=15ms)	2-pole in series	24V	-	220	-	300	-
48V			-	180	-	240	-	240
110V			-	150	-	200	-	200
3-pole in series		24V	-	220	-	300	-	400
		48V	-	220	-	300	-	400
		110V	-	220	-	300	-	400
DC3, 4 duty (L/R=15ms)	2-pole in series	24V	-	220	-	300	-	400
		48V	-	150	-	200	-	200
		110V	-	120	-	150	-	150
	3-pole in series	24V	-	220	-	300	-	400
		48V	-	220	-	280	-	280
		110V	-	150	-	200	-	200
Directly mountable overload relay					MT-400			
Conductor size (Solid, stranded) (The max. number of conducts: 2)	AWG	3/0~500		4/0~500		350~700		
	mm ²	95~240		95~240		185~370		
Conductor type					75°C Cu stranded wire			



Coil voltage, AC/DC common

Nominal(ordering) voltage	AC 50/60Hz	DC	Certification • CE(IEC) • UL508 • CCC
100V / 200V	100 - 240V	100 - 110V	
300V	265 - 347V	-	
400V	380 - 450V	-	
500V	440 - 575V	-	

Accessories

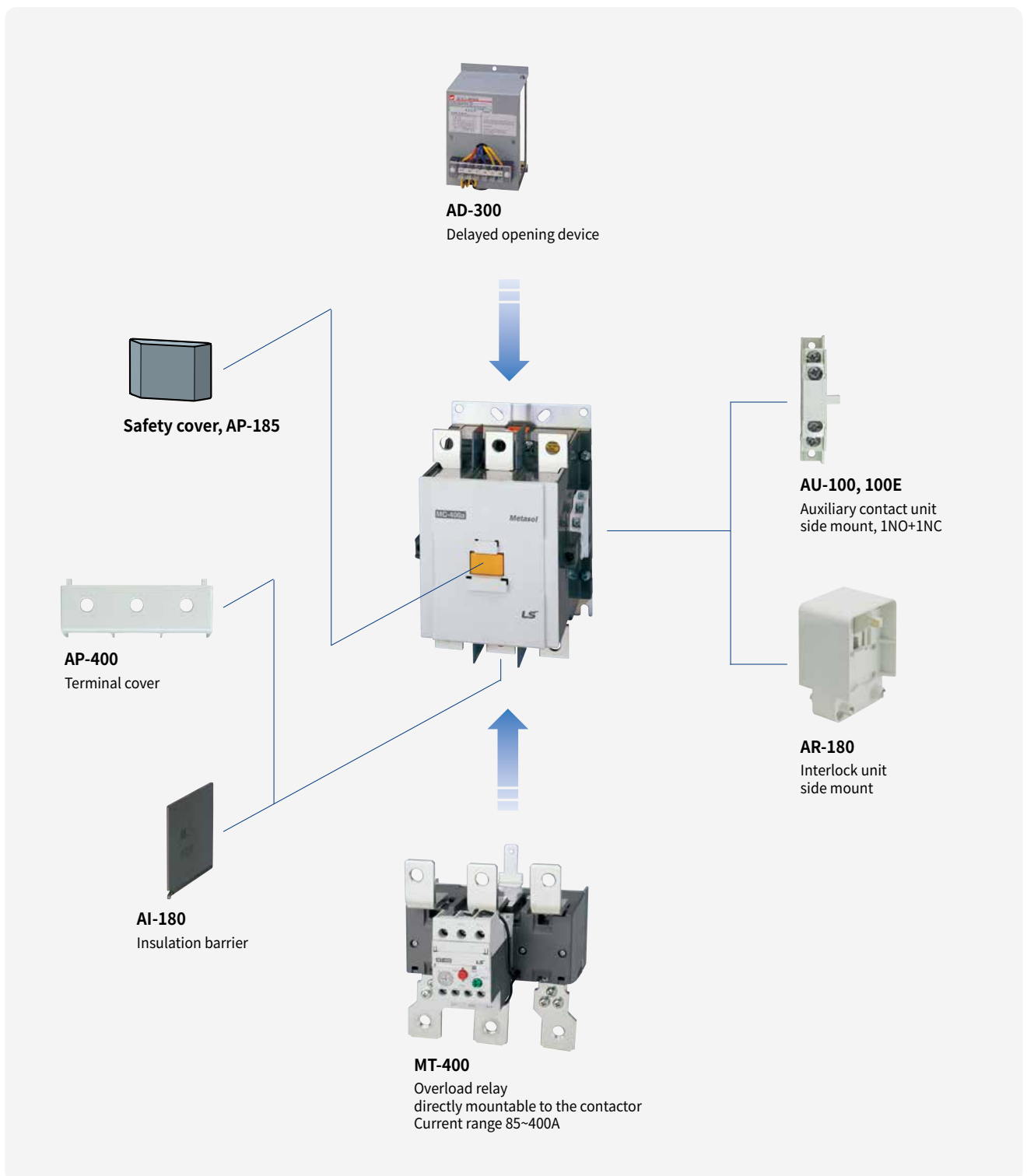

Contactors

Description 800AF

- 3-pole main contact
- AC/DC common use coil built
- Wide coil operation voltage
- Screw mountable
- 2NO+2NC Auxiliary contacts built-in as standard
- Top/side mountable accessories available
- Overload relays available
- Degree of protection: IP00



MC-800a

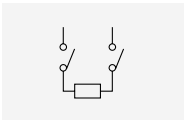

2pole for DC contact

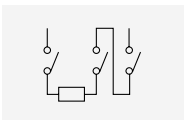

3pole for DC contact

Rating

Contactor type			MC-500a		MC-630a		MC-800a		
			kW	A	kW	A	kW	A	
AC duty	AC3	200/240V	147	500	190	630	220	800	
		380/440V	265	500	330	630	440	800	
		500/550V	265	400	330	500	500	720	
		690V	300	380	400	420	500	630	
		1000V	280	220	280	220	280	220	
	AC4	200/240V	90	350	110	400	160	630	
		380/440V	176	350	200	400	300	630	
	AC1		-	700	-	900	-	1050	
	DC1 duty (L/R=1ms)	2-pole in series	24V	-	400	-	630	-	800
48V			-	240	-	630	-	800	
110V			-	200	-	630	-	630	
3-pole in series		24V	-	400	-	630	-	800	
		48V	-	400	-	630	-	800	
		110V	-	400	-	630	-	800	
DC3, 4 duty (L/R=15ms)		2-pole in series	24V	-	400	-	630	-	800
			48V	-	200	-	630	-	630
			110V	-	150	-	630	-	630
	3-pole in series	24V	-	400	-	630	-	800	
		48V	-	280	-	630	-	630	
		110V	-	200	-	630	-	630	
Directly mountable overload relay					MT-800				
Conductor size (Solid, stranded) (The max. number of conducts: 2)	AWG	350~800		600~2000		1700~Busbar			
	mm ²	185~480		-		-			
Conductor type					75°C Cu stranded wire				



Coil voltage, AC/DC common

Nominal(ordering) voltage	AC 50/60Hz	DC	Certification • CE(IEC) • UL508 • CCC
100V	100 - 127V	100 - 110V	
200V	200 - 240V	200 - 220V	
300V	265 - 347V	-	
400V	380 - 450V	-	
500V	440 - 575V	-	

Accessories

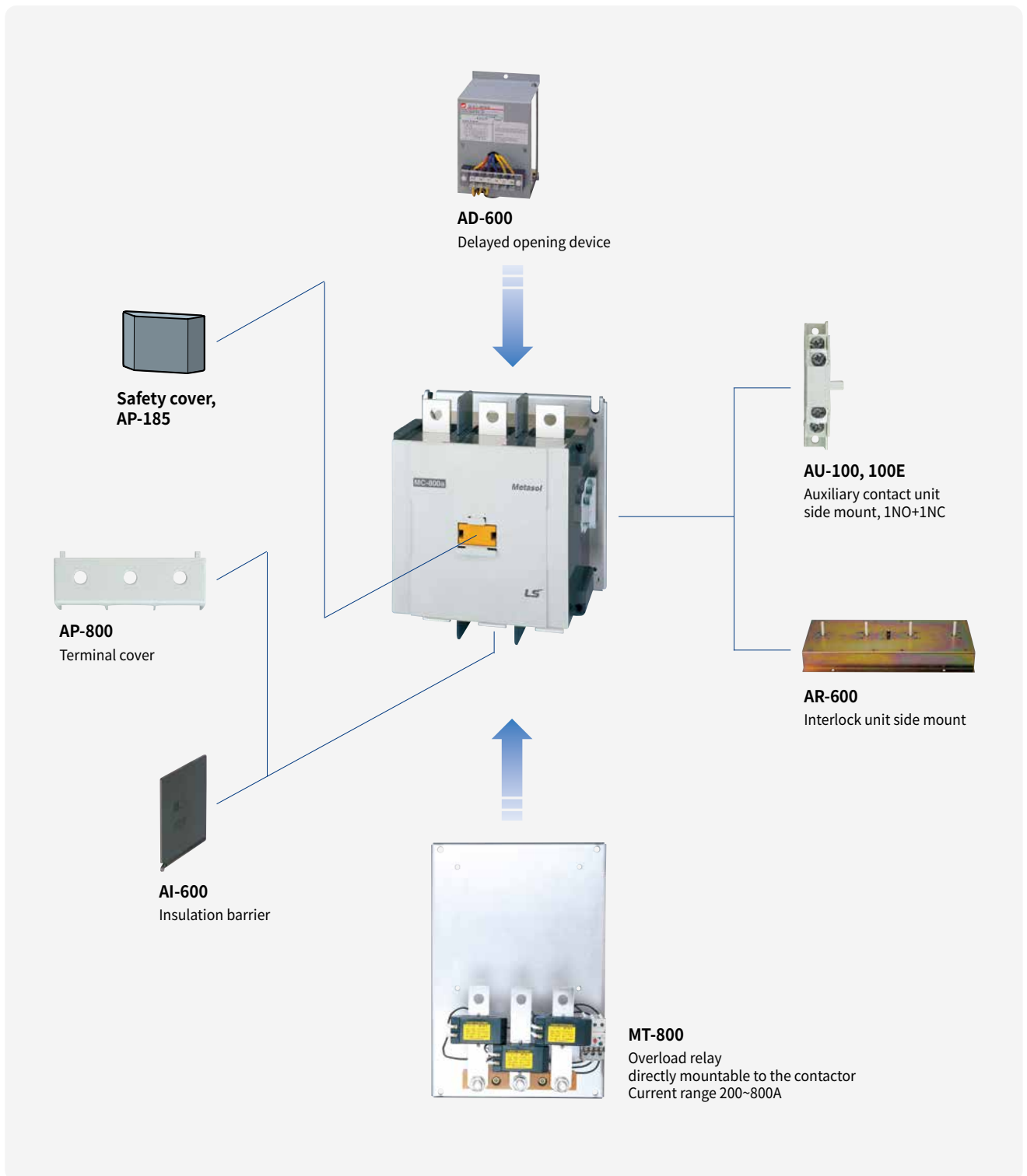

Contactors

Description 1260AF

- 3-pole main contact
- AC/DC common use coil built
- Wide coil operation voltage
- Screw mountable
- 2NO+2NC Auxiliary contacts built-in as standard
- Side mountable accessories available
- Degree of protection: IP00



MC-1260a

Rating

Contactor type		MC-1260a		
		kW	A	
AC duty	AC3	200/240V	-	-
		380/440V	-	-
		500/550V	-	-
		690V	-	-
		1000V	-	-
	AC1	-	1260	
Conductor size (Solid, stranded) (mm)	Busbar	50 x 10 x 2ea		
Conductor type	Busbar			

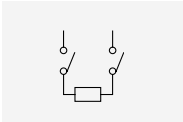

2pole for DC contact

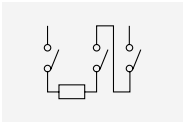

3pole for DC contact



Coil voltage, AC/DC common

Nominal(ordering) voltage	AC 50/60Hz	DC
100V / 200V	100 - 240V	100 - 220V

Certification
<ul style="list-style-type: none"> • CE(IEC) • UL, UL/cUL

Accessories



AI-800
Insulation barrier

AU-100, 100E
Auxiliary contact unit
side mount, 1NO+1NC

Contactors

Description 2650AF

- 3-pole main contact
- AC/DC common use coil built
- Wide coil operation voltage
- Screw mountable
- 2NO+2NC Auxiliary contacts built-in as standard
- Side mountable accessories available
- Degree of protection: IP00



Rating

Contactor type			MC-1400a		MC-1700a		MC-2100a		MC-2650a	
			kW	A	kW	A	kW	A	kW	A
AC duty	AC3	200/240V	290	860	310	1050	-	-	-	-
		380/440V	550	860	700	1050	900	1450	-	-
		500/550V	-	-	-	-	-	-	-	-
		690V	800	800	1000	950	-	-	-	-
		1000V	-	-	-	-	-	-	-	-
	AC1		-	1400	-	1700	-	2100	-	2650
Conductor size (Solid, stranded) (mm)		Busbar	100 x 5 x 2ea		100 x 5 x 3ea		100 x 5 x 4ea		100 x 10 x 3ea	
Conductor type			Busbar							



Coil voltage, AC/DC common

Nominal(ordering) voltage	AC 50/60Hz	DC
100V / 200V	100 - 240V	100 - 220V

Certification
<ul style="list-style-type: none"> • CE(IEC) • UL60947-4-1 • CCC

Accessories



AU-100, 100E
Auxiliary contact unit
side mount, 1NO+1NC



Insulation barrier
AI-2100(MC-1400a~2100a)
AI-2650(MC-2650a)

Renewal Magnetic Contactor

Accessories 1260AF

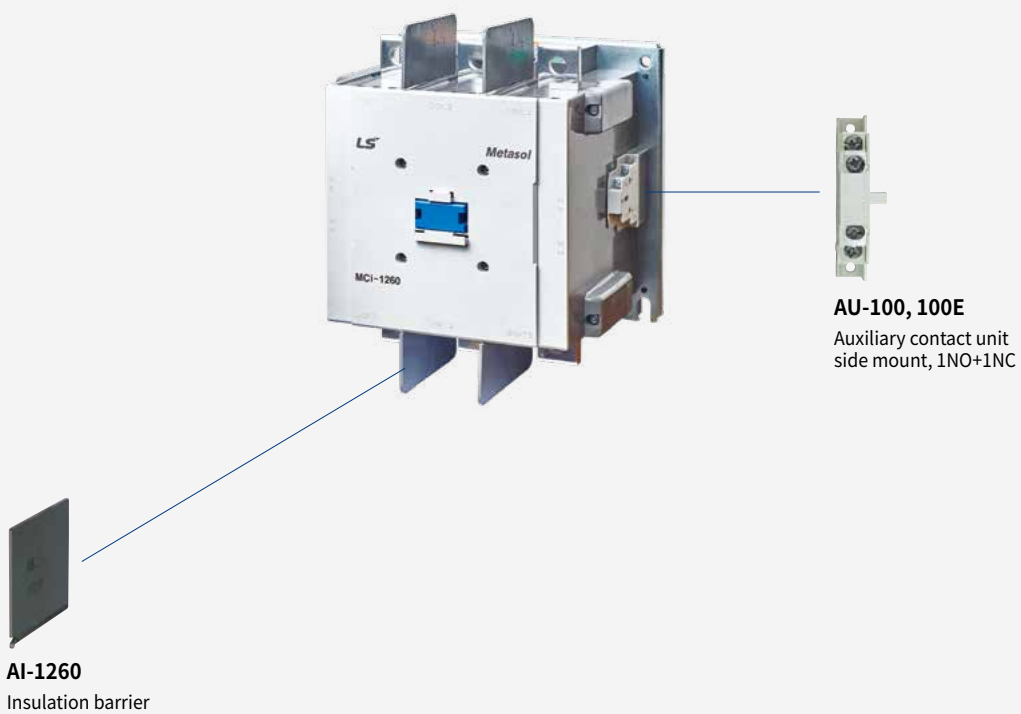

Accessories 2650AF

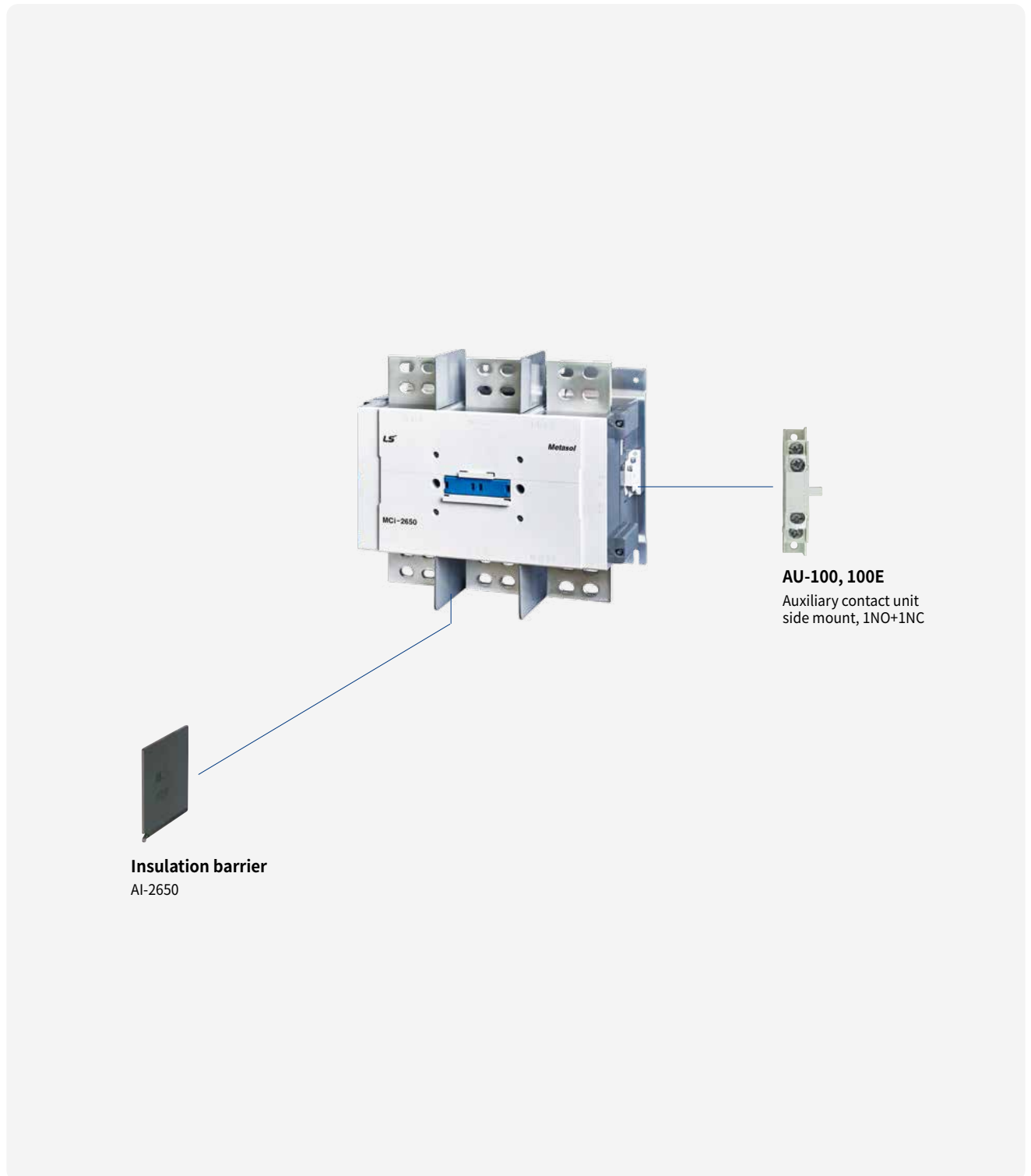

Insulation barrier
AI-2650

AU-100, 100E
Auxiliary contact unit
side mount, 1NO+1NC

Motor starters

Description

- Opened direct motor starter
- 3-pole(NO) main contact
- Finger proof design
- DIN rail or screw mountable
- AC or DC control contactor selectable
- Front/side mountable accessories available
- Overload relay is directly mounted to the contactor
- Degree of protection: IP20



Rating

Frame size				18AF				22AF			
Type				MC-6a	MC-9a	MC-12a	MC-18a	MC-9b	MC-12b	MC-18b	MC-22b
Number of poles				3				3			
Rated operational voltage (Ue)				690V				690V			
Degree of pollution (IEC60529)				IP20				IP20			
Rated operational current Ie (θ≤40°C)	AC-1	Ue max 690V	[A]	25	25	25	32	25	27	40	45
	AC-3	200/240V	[A]	9	11	13	18	11	13	18	22
		380/400V	[A]	7	9	12	18	9	12	18	22
		415V	[A]	7	9	12	18	9	12	18	22
		440V	[A]	7	9	12	18	9	12	18	22
		500V	[A]	6	7	12	13	7	12	13	20
		690V	[A]	4	5	9	9	6	9	9	18
1000V	[A]	-	-	-	-	-	-	-	-	-	
Rated operational power (θ≤40°C)	AC-3	200/240V	[kW]	2.2	2.5	3.5	4.5	2.5	3.5	4.5	5.5
		380/400V	[kW]	3	4	5.5	7.5	4	5.5	7.5	11
		415V	[kW]	3	4	5.5	7.5	4	5.5	7.5	11
		440V	[kW]	3	4	5.5	7.5	4	5.5	7.5	11
		500V	[kW]	3	4	7.5	7.5	4	7.5	7.5	15
		690V	[kW]	3	4	7.5	7.5	4	7.5	7.5	15
1000V	[kW]	-	-	-	-	-	-	-	-	-	
According to IEC60947-4-1	Rated making capacity AC-3			70	90	120	180	90	120	180	220
	Rated breaking capacity AC-3			56	72	96	144	72	96	144	176
Electrical life for Ie / AC-3 Max in millions of operating cycles				2.5	2.5	2.5	2.5	2.5	2.5	2.5	2.5
Maximum operating rate in operating cycles per hour				1800	1800	1800	1800	1800	1800	1800	1800

Devices usable in the starter combination

Contactors			18AF				22AF			
with AC or DC control coil			MC-6a	MC-9a	MC-12a	MC-18a	MC-9b	MC-12b	MC-18b	MC-22b
with coil in common use for AC and DC			-	-	-	-	-	-	-	-
Thermal overload relays			18AF				22AF			
Class 10	Differential type		MT-12/3K				MT-32/3K			
	Non-differential type		MT-12/3H				MT-32/3H			
	Non-differential type(2-heater)		MT-12/2H				MT-32/2H			
Class 20	Differential type		MT-12/3D				MT-32/3D			
Setting range A			0.1~18A				0.1~40A			



40AF		65AF		100AF		
MC-32a	MC-40a	MC-50a	MC-65a	MC-75a	MC-85a	MC-100a
3		3		3		
690V		690V		690V		
IP20		IP20		IP20		
55	60	100	115	125	135	160
32	40	55	65	75	85	105
32	40	50	65	75	85	105
32	40	50	65	75	85	105
32	40	50	65	75	85	105
28	32	43	60	64	75	85
20	23	28	35	42	45	65
17	17	23	23	28	28	28
7.5	11	15	18.5	22	25	30
15	18.5	22	30	37	45	55
15	18.5	22	30	37	45	55
15	18.5	22	30	37	45	55
18.5	22	30	33	37	45	55
18.5	22	30	33	37	45	55
22	22	30	30	37	37	37
320	400	500	650	750	850	1050
256	320	400	520	600	650	840
2	2	2	2	2	2	2
1800	1800	1200	1200	1200	1200	1200

40AF		65AF		100AF		
MC-32a	MC-40a	MC-50a	MC-65a	MC-75a	MC-85a	MC-100a
-	-	-	-	-	-	-
40AF		65AF		100AF		
MT-32/3K		MT-63/3K		MT-95/3K		
MT-32/3H		MT-63/3H		MT-95/3H		
MT-32/2H		MT-63/2H		MT-95/2H		
MT-32/3D		MT-63/3D		MT-95/3D		
0.1~40A		4~65A		7~100A		

Motor starters

Description

- Opened direct motor starter
- 3-pole(NO) main contacts
- Screw mountable
- AC/DC common use control contactor used (from 225AF)
- Additional accessories available
- Overload relay is directly mounted to the contactor
- Degree of protection: IP20



Rating

Frame size				150AF		225AF		
Type				MS-130a	MS-150a	MS-185a	MS-225a	
Number of poles				3		3		
Rated operational voltage (Ue)				690V		690V		
Degree of pollution (IEC60529)				IP20		IP20		
Rated operational current Ie (θ≤40°C)	AC-1	Ue max 690V	[A]	200	250	300	350	
		AC-3		130	150	185	225	
		200/240V	[A]	130	150	185	225	
		380/400V	[A]	130	150	185	225	
		415V	[A]	130	150	185	225	
		440V	[A]	130	150	185	225	
		500V	[A]	90	100	180	200	
	690V	[A]	60	60	120	150		
	1000V	[A]	50	50	90	90		
Rated operational power (θ≤40°C)	AC-3	200/240V	[kW]	37	45	55	75	
		380/400V	[kW]	60	75	90	132	
		415V	[kW]	60	75	90	132	
		440V	[kW]	60	75	90	132	
		500V	[kW]	60	70	110	132	
		690V	[kW]	55	55	110	140	
	1000V	[kW]	75	90	132	132		
According to IEC60947-4-1	Rated making capacity AC-3			1200	1500	1850	2250	
	Rated breaking capacity AC-3			960	1200	1480	1800	
Electrical life for Ie / AC-3 Max in millions of operating cycles				1	1	1	1	
Maximum operating rate in operating cycles per hour				1200	1200	1200	1200	

Devices usable in the starter combination

Contactors			150AF		225AF		
with AC or DC control coil			MC-130a	MC-150a	-	-	
with coil in common use for AC and DC			-	-	MC-185a	MC-225a	
Thermal overload relays			150AF		225AF		
Class 10	Differential type		MT-150/3K		MT-225/3K		
	Non-differential type		MT-150/3H		MT-225/3H		
	Non-differential type(2-heater)		MT-150/2H		MT-225/2H		
Class 20	Differential type		MT-150/3D		MT-225/3D		
Setting range A			34~150A		65~240A		



	400AF			800AF		
	MS-265a	MS-330a	MS-400a	MS-500a	MS-630a	MS-800a
		3			3	
		690V			690V	
		IP20			IP20	
	400	500	520	700	900	1050
	265	330	400	500	630	800
	265	330	400	500	630	800
	265	330	400	500	630	800
	265	330	400	500	630	800
	225	280	350	400	500	720
	185	220	300	380	420	630
	105	105	105	220	220	220
	80	90	125	147	190	220
	147	160	200	265	330	440
	147	160	200	265	330	440
	147	160	200	265	330	440
	147	160	225	265	330	500
	160	200	250	300	400	500
	147	147	147	280	280	280
	2650	3300	4000	5000	6300	8000
	2120	2640	3200	4000	5040	6400
	1	1	0.5	0.5	0.5	0.5
	1200	1200	1200	1200	1200	1200

	400AF			800AF			
	-	-	-	-	-	-	
	MC-265a	MC-330a	MC-400a	MC-500a	MC-630a	MC-800a	
		400AF			800AF		
		MT-400/3K			MT-800/3K		
		MT-400/3H			MT-800/3H		
		MT-400/2H			MT-800/2H		
		MT-400/3D			MT-800/3D		
		85~400A			200~800A		

Reversing contactors

Description

- Two AC or DC control contactors are interlocked mechanically and electrically
- 3-pole(NO) main contact in each contactor
- Finger proof design
- DIN rail or screw mountable
- Front/side mountable accessories available
- Overload relay can be directly mounted to the contactor if necessary
- Please use interval time of over 25ms
- Degree of protection: IP20

Circuit diagram

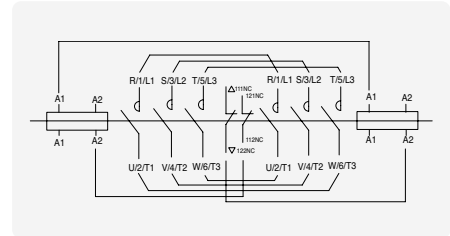

Rating

Type	AC-3 duty							Current (AC3)	Weight (AC control)
	200~240V	380~400V	415V	440V	500V	690V	1000V	440V	
	kW	kW	kW	kW	kW	kW	kW	A	
MC-6a/R	2.2	3	3	3	3	3	-	7	0.63kg
MC-9a/R	2.5	4	4	4	4	4	-	9	0.63kg
MC-12a/R	3.5	5.5	5.5	5.5	7.5	7.5	-	12	0.63kg
MC-18a/R	4.5	7.5	7.5	7.5	7.5	7.5	-	18	0.63kg
MC-9b/R	2.5	4	4	4	4	4	-	9	0.75kg
MC-12b/R	3.5	5.5	5.5	5.5	7.5	7.5	-	12	0.75kg
MC-18b/R	4.5	7.5	7.5	7.5	7.5	7.5	-	18	0.75kg
MC-22b/R	5.5	11	11	11	15	15	-	22	0.75kg
MC-32a/R	7.5	15	15	15	18.5	18.5	22	32	0.95kg
MC-40a/R	11	18.5	18.5	18.5	22	22	22	40	0.95kg
MC-50a/R	15	22	22	22	30	30	30	50	1.9kg
MC-65a/R	18.5	30	30	30	33	33	30	65	1.9kg
MC-75a/R	22	37	37	37	37	37	37	75	3.4kg
MC-85a/R	25	45	45	45	45	45	37	85	3.4kg
MC-100a/R	30	55	55	55	55	55	37	105	3.4kg



Coil voltage

AC	50Hz	24, 32, 42, 48, 80, 100, 110, 220, 230, 240, 380, 400, 500, 550V
	60Hz	24, 48, 100, 110, 120, 200, 208, 220, 230, 240, 277, 380, 480, 600V
DC		12, 20, 24, 48, 60, 80, 100, 110, 125, 200, 220, 250V

Certification
<ul style="list-style-type: none"> • CE(IEC) • UL508 • CCC

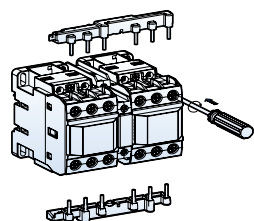

Description

- 3-pole main contact
- Mechanically interlocked
- AC/DC common use coil built (from MC-185a/R)
- Wide coil operation voltage
- Screw mountable
- 4NO4NC Auxiliary contacts built-in
- Top/side mountable accessories available
- Please use interval time of over 50ms
- Degree of protection: IP20

Rating



Type	AC-3 duty							Current (AC3)	Weight (AC control)
	200~240V	380~400V	415V	440V	500V	690V	1000V	440V	
	kW	kW	kW	kW	kW	kW	kW	A	
MC-130a/R	37	60	60	60	60	55	75	130	4.3kg
MC-150a/R	45	75	75	75	70	55	75	150	4.3kg
MC-185a/R	55	90	90	90	110	110	132	185	13kg
MC-225a/R	75	132	132	132	132	140	132	225	13kg
MC-265a/R	80	147	147	147	147	160	147	265	21.4kg
MC-330a/R	90	160	160	160	160	200	147	330	21.4kg
MC-400a/R	125	200	200	225	225	250	147	400	21.4kg
MC-500a/R	147	265	265	265	265	300	280	500	60kg
MC-630a/R	190	330	330	330	330	400	280	630	60kg
MC-800a/R	220	440	440	440	440	500	280	800	60kg



Coil voltage

For MC130a/R and MC-150a/R	AC	50/60Hz	24, 48, 100~240, 110~120, 220~240, 300, 380~440, 500V
		DC	

For MC-185a/R ~ MC-800a/R	- 24, 48, 100/200, 300, 400, 500V for types MC-185a/R, 225a/R - 100/200, 300, 400, 500V for types MC-265a/R, 330a/R, 400a/R - 100, 200, 300, 400, 500V for types MC-500a/R, 600a/R, 800a/R
---------------------------	--

Nominal(ordering) voltage	AC 50/60Hz	DC
24V	24 - 25V	24V
48V	48 - 50V	48V
100V	100 - 127V	100 - 110V
200V	200 - 240V	200 - 220V
100/200V	100 - 240V	100 - 220V
300V	265 - 347V	-
400V	380 - 450V	-
500V	440 - 575V	-

LED voltage monitoring contactor

Description



Real time observe coil voltage without additional equipments for protect coil burn out due to the under and over voltage

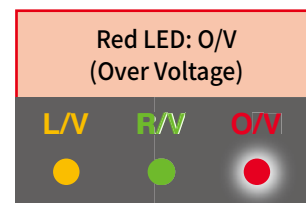
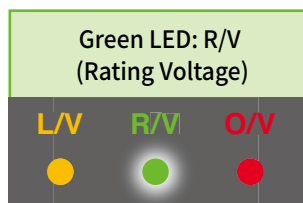
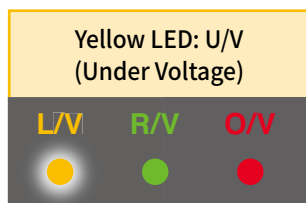

Coil voltage

Type	Coil voltage	LED indicate statue		
		Under voltage (Yellow)	Rating voltage (Green)	Over voltage (Red)
MC-130a, MC 150a	110V	~80V	80~130V	130V~
	220V	~160V	160~260V	260V~
	400V	~330V	330~480V	280V~
MC-185a, MC-225a	110V	~80V	80~130V	130V~
	220V	~160V	160~260V	260V~
	400V	~330V	330~480V	280V~
MC-265a, MC-330a MC-400a	110V	~80V	80~130V	130V~
	220V	~160V	160~260V	260V~
	400V	~330V	330~480V	280V~
MC-500a, MC-630a MC-800a	110V	~80V	80~130V	130V~
	220V	~160V	160~260V	260V~

* The accuracy of LED indicate statue is $\pm 5\%$

Description

- 4,6,8 pole units
- AC/DC control voltage
- 16A continuous current, lth
- DIN rail or screw mountable
- Degree of protection: IP20

Selection



MR-4



MR-6



MR-8

Poles	Composition	Types	Remarks
4 pole	4NO 3NO1NC 2NO2NC 1NO3NC 4NC	MR-4	Additional auxiliary contacts can be mounted on the relays.
6 pole	6NO 5NO1NC 4NO2NC 3NO3NC 2NO4NC	MR-6	UA-2 is mounted on the MR-4.
8 pole	8NO 7NO1NC 6NO2NC 5NO3NC 4NO4NC	MR-8	UA-4 is mounted on the MR-4.

Note) Product indicated "Low" is for Low current application

Rating

Rated insulation voltage (Ui)		AC 690V					
Continuous current (lth)		16A					
Operating cycle		1800 operations/hour					
Endurance	Mechanical life time	10 mil. operations					
	Electrical life time	0.25 mil. operations					
Type		MR-4	MR-6	MR-8			
AC-15	Rated current (A)	120V	6	6	6		
		240V	3	3	3		
		380V	1.9	1.9	1.9		
		480V	1.5	1.5	1.5		
		500V	1.4	1.4	1.4		
		600V	1.2	1.2	1.2		
DC-13	Rated current (A)	125V	1.1	1.1	0.55	1.1	0.55
		250V	0.55	0.55	0.27	0.55	0.27
		400V	0.31	0.31	0.15	0.31	0.15
		500V	0.27	0.27	0.13	0.27	0.13
		600V	0.2	0.2	0.1	0.2	0.1
		Minimum rated through current		DC 24V 10mA			



Coil voltage

AC	50Hz	24, 32, 42, 48, 65, 80, 100, 110, 120, 220, 230, 240, 380, 400, 500, 550V
	60Hz	24, 48, 110, 120, 200, 208, 220, 230, 240, 277, 380, 480, 600V
DC		12, 20, 24, 30, 48, 60, 80, 100, 110, 125, 200, 220, 250V
Voltage limit		85%~110%

Note)
See page 22, 23 for details.
* Please be cautious for wiring control power cable, especially "+" (Positive) and "-" (Negative) polarity should be correctly considered.

Contactors relays for micro current

Description

- 2,4,8 pole units
- AC/DC control voltage
- 0.5 mil. operations, 2.5 mil. operations
- DIN rail or screw mountable (35mm)
- Degree of protection: IP20

* Do not place strong magnets around the main circuit.

Type



MR-4E



MR-8E

Number of poles	Contact configuration		Types	Remarks
	Micro contact	Normal contact		
2 pole	1a1b	-	UA-1E AU-100E	Auxiliary contact unit (UA-1E)
4 Pole	2a 1a1b 2b	2a 1a1b 2b	MR-4E or UA-4E	Auxiliary relay (MR-4E) or Auxiliary contact unit (UA-4E)
8 Pole	4a 3a1b 2a2b 1a3b 4b	4a 3a1b 2a2b 1a3b 4b	MR-8E (MR-4E + UA-4E)	Auxiliary relay (MR-4E) and Auxiliary contact unit (UA-4E)

* MR-4E UA-4E 'Negative sides of both sides' is the contact for microcurrent.

* UA-1E is applicable to 150AF or less. (Above 225AF, AU-100E is available.)

* Please note that contact welding may occur when a high voltage is applied to the contact for micro current, not the rated voltage.



UA-4E



UA-1E

Rating

		Micro contact	Normal contact
Rated operational voltage (Ue)		AC 130V, DC 180V MAX.	AC 600V
Continuous current (Ith)		1A	16A
Switching current		0.7A MAX.	6A
Contact capacity		10VA (10W) Less	720VA
Rated insulation voltage (Ui)		DC 200V	AC 690V
Operating cycle (AC1)		1800 operations/hour	1800 operations/hour
Endurance	Mechanical	2.5 mil. operations	10 mil. operations
	Electrical	0.5 mil. operations	0.25 mil. operations
Minimum rated through current		DC 5V 0.5mA	DC 24V 10mA
Contact reliability		1×10^{-8}	4×10^{-6}



Coil voltage

AC	50Hz	24, 32, 36, 42, 48, 65, 80, 100, 110, 120, 220, 230, 240, 380, 400, 415, 440, 500, 550V
	60Hz	24, 48, 110, 120, 200, 208, 220, 230, 240, 277, 380, 440, 480, 600V
DC		12, 20, 24, 30, 48, 60, 80, 100, 110, 125, 200, 220, 250V
Temperature Range		85%~110%

Note) 1. Coil For detailed specifications, refer to Operating Coil Rating and Characteristics data (22AF) on Catalog 22 page.

2. For DC type products, be sure to wire the polarity of the + and - polarities when wiring the coil terminals.

Contact configuration

2a+2a

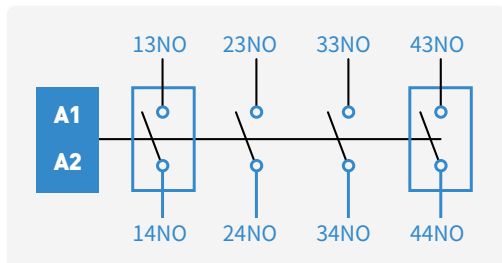

2a+1a1b

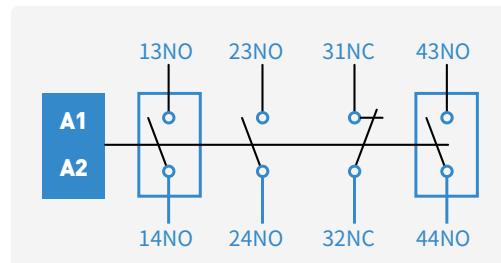

2a+2b

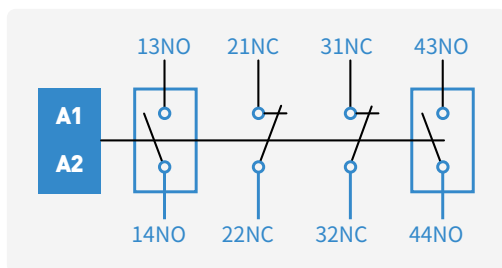

1a1b+2a

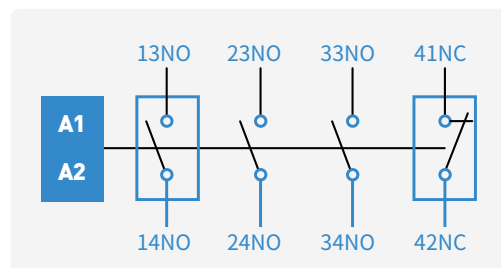

1a1b+1a1b

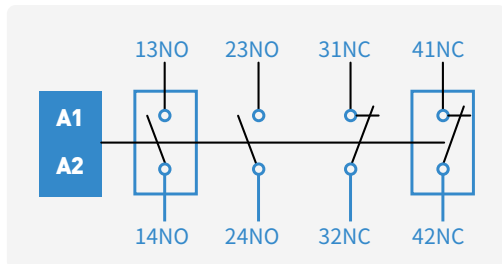

1a1b+2b

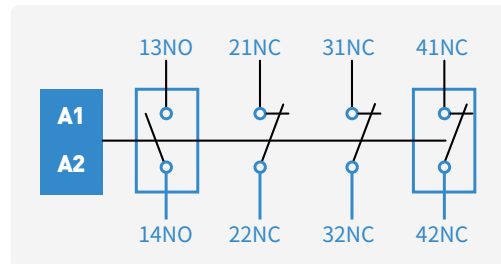

2b+2a

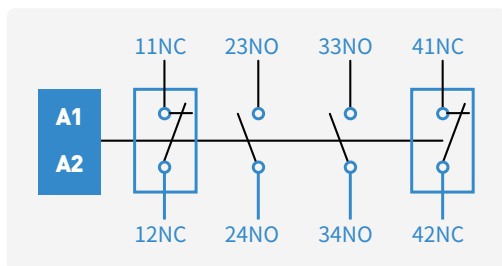

2b+1a1b

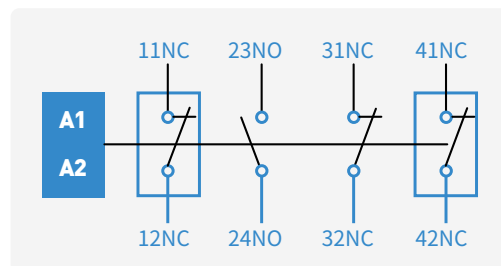

2b+2b

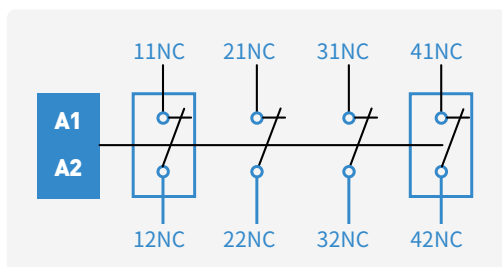

* □ is micro contact.

Latching contactors

Description 9~150AF

- 3-pole main contact
- Mechanically latched
- Finger proof design
- DIN rail or screw mountable
- Side mountable accessories available
- Direct mountable overload relays available

Circuit diagram

MC-6a/L~150a/L

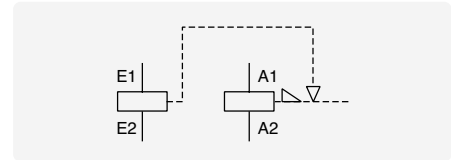

Rating



Contactor	AC3 ratings					Devices combined			
	200 / 240V kW	380 / 440V kW	500 / 550V kW	690V kW	1000V kW	Type	Durability (Mechanical)	Operational time	Excitation time
MC-6a/L	2.2	3	3	3	-	ML-65	0.5 mil.	Less 30ms (AC)	More than 50ms (AC)
MC-9a/L	2.5	4	4	4	-				
MC-12a/L	3.5	5.5	7.5	7.5	-				
MC-18a/L	4.5	7.5	7.5	7.5	-				
MC-9b/L	2.5	4	4	4	-				
MC-12b/L	3.5	5.5	7.5	7.5	-				
MC-18b/L	4.5	7.5	7.5	7.5	-				
MC-22b/L	5.5	11	15	15	-				
MC-32a/L	7.5	15	18.5	18.5	22				
MC-40a/L	11	18.5	22	22	22				
MC-50a/L	15	22	30	30	30	ML-150	2.5 mil.	Less 50ms (DC)	More than 70ms (DC)
MC-65a/L	18.5	30	33	33	30				
MC-75a/L	22	37	37	37	37				
MC-85a/L	25	45	45	45	37				
MC-100a/L	30	55	55	45	37				
MC-130a/L	37	60	60	55	75				
MC-150a/L	45	75	75	55	75	Less 100ms	More than 130ms		

*When the open signal is input for more than 1 second, the coil of the latch is burned.



Coil voltage

AC	50/60Hz	24, 48, 100, 110, 120, 200, 220, 230, 240, 380, 400, 415, 440V
DC		24, 48, 110V

Certification

- CE(IEC)
- UL508

Accessories

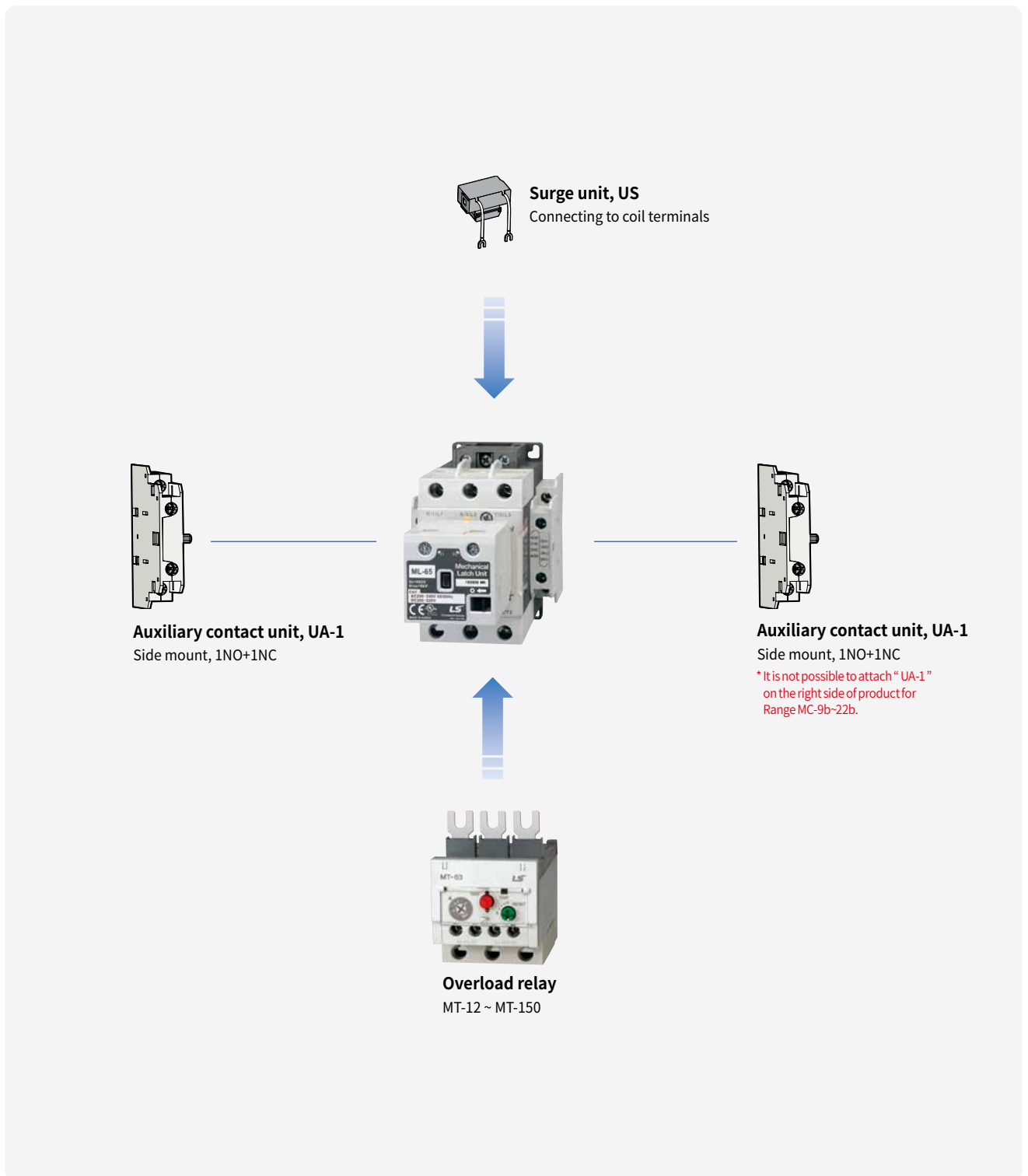

Latching contactors

Description 185~400AF

- 3-pole main contact
- Mechanically interlocked
- AC/DC common use coil built
- Wide coil operation voltage
- Screw mountable
- 1NO+2NC auxiliary contacts built-in as standard
- Top/side mountable accessories available

Circuit diagram

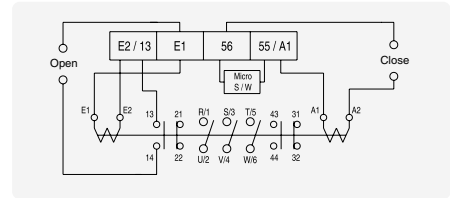

Rating

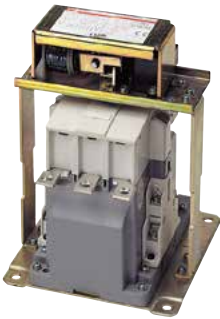

Contactor	AC3 ratings					Auxiliary contact (Standard)
	200~240V	380~440V	500~550V	690V	1000V	
MC-185a/L	55kW 185A	90kW 185A	110kW 180A	110kW 120A	132kW 90A	2NO2NC* (1NO2NC)
MC-225a/L	75kW 225A	132kW 225A	132kW 200A	140kW 150A	132kW 90A	
MC-265a/L	80kW 265A	147kW 265A	147kW 225A	160kW 185A	147kW 105A	
MC-330a/L	90kW 330A	160kW 330A	160kW 280A	200kW 220A	147kW 105A	
MC-400a/L	125kW 400A	200kW 400A	225kW 350A	250kW 300A	147kW 105A	

* 1NO contact of 2NO2NC is used in Latch and customer contact is 1NO2NC. If 2NO or higher is used, additional attachment of AU-100 is required.

Coil voltage

Nominal(ordering) voltage	Operational voltage	Operation frequency
100V	AC100~127V	600 operations/hour
	DC100~125V	300 operations/hour
200V	AC200~240V	600 operations/hour
	DC200~220V	300 operations/hour

Accessories

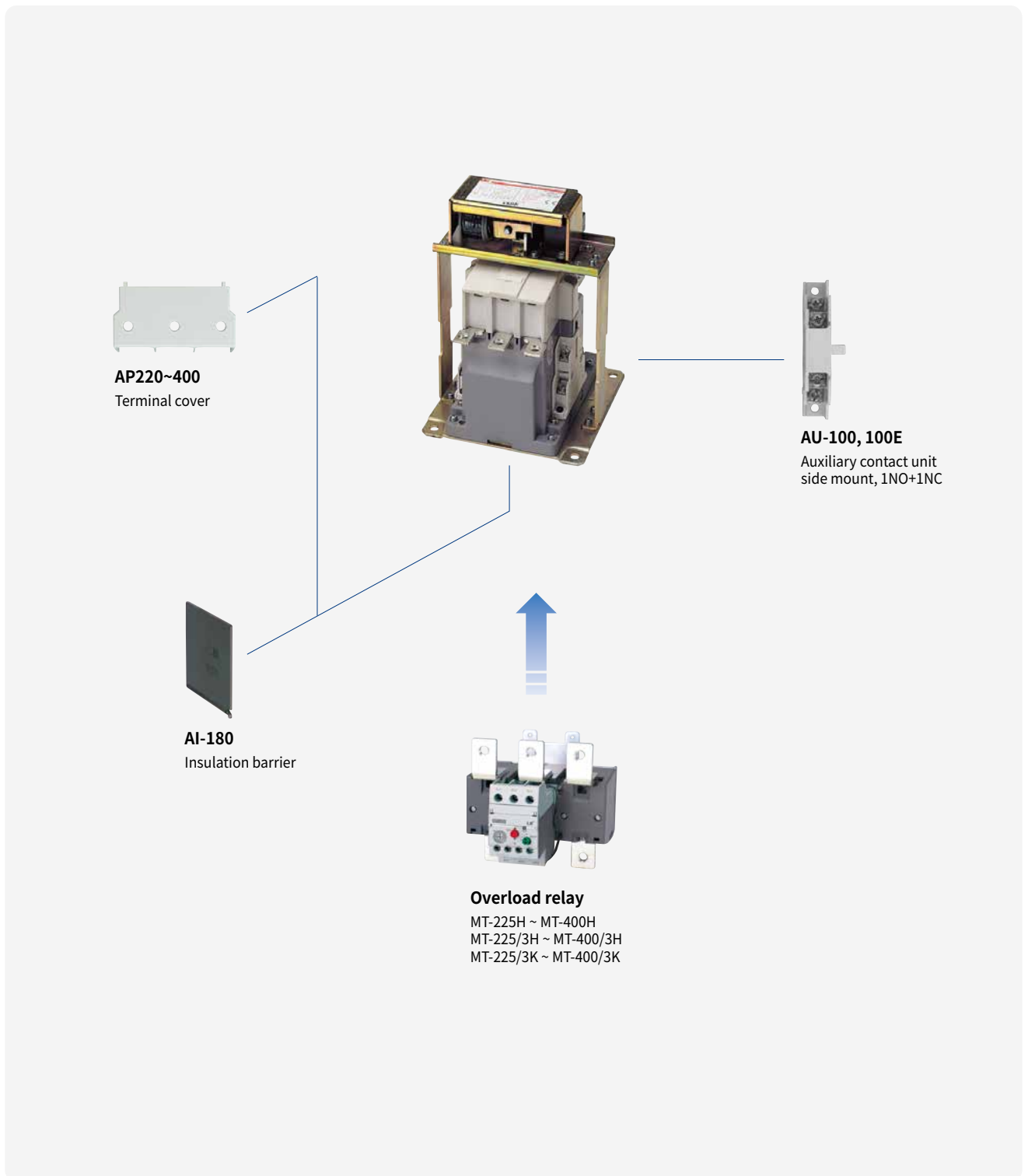

4-pole contactors

Description 18AF

- 4-pole main contact
- Finger proof design
- DIN rail or screw mountable
- Small physical size: 44 mm wide
- Auxiliary contacts are optional
- Front/side mountable accessories
- Direct mountable overload relays available
- Degree of protection: IP20

Rating



MC-18a/4

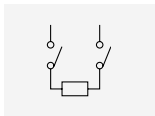

2pole for DC contact

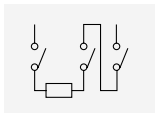

3pole for DC contact

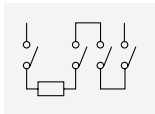

4pole for DC contact

Contactor type			MC-6a/4		MC-9a/4		MC-12a/4		MC-18a/4	
			kW	A	kW	A	kW	A	kW	A
AC duty	AC1	200/240V	9	25	9	25	9	25	15	40
		380/440V	17	25	17	25	17	25	27	40
		500/550V	21	25	21	25	21	25	35	40
		690V	27	25	27	25	27	25	44	40
	AC3	200/240V	2.2	9	2.5	11	3.5	13	4.5	18
		380/440V	3	7	4	9	5.5	12	7.5	18
		lth	-	25	-	25	-	25	-	40
DC1 duty (L/R=1ms)	2-pole in series	110V	-	6	-	6	-	10	-	13
		220V	-	3	-	3	-	7	-	8
	3-pole in series	110V	-	8	-	8	-	12	-	18
		220V	-	8	-	8	-	12	-	18
	4-pole in series	110V	-	10	-	10	-	15	-	20
		220V	-	10	-	10	-	12	-	20
UL rating			hp	A	hp	A	hp	A	hp	A
220/240V			3	-	3	-	5	-	7.5	-
440/480V			5	-	5	-	7.5	-	10	-
550/600V			7.5	-	7.5	-	10	-	15	-
lth			-	25	-	25	-	25	-	32
Conductor size (Solid, stranded) (The max. number of conducts: 2)		AWG	18~10		18~10		16~10		16~8	
		mm ²	1.5~4		1.5~10		1.5~10		1~4	
Conductor type			65/75°C Cu-wire only							



Coil voltage

AC	50Hz	24, 32, 42, 48, 80, 100, 110, 220, 230, 240, 380, 400, 500, 550V
	60Hz	24, 48, 100, 110, 120, 200, 208, 220, 230, 240, 277, 380, 480, 600V
	50/60Hz	24, 48, 100, 110, 120, 200, 220, 230, 240, 380, 415, 440, 500, 550V
DC		12, 20, 24, 30, 48, 60, 80, 100, 110, 125, 200, 220, 250V

Certification

- CE(IEC)
- UL508
- CCC

Accessories

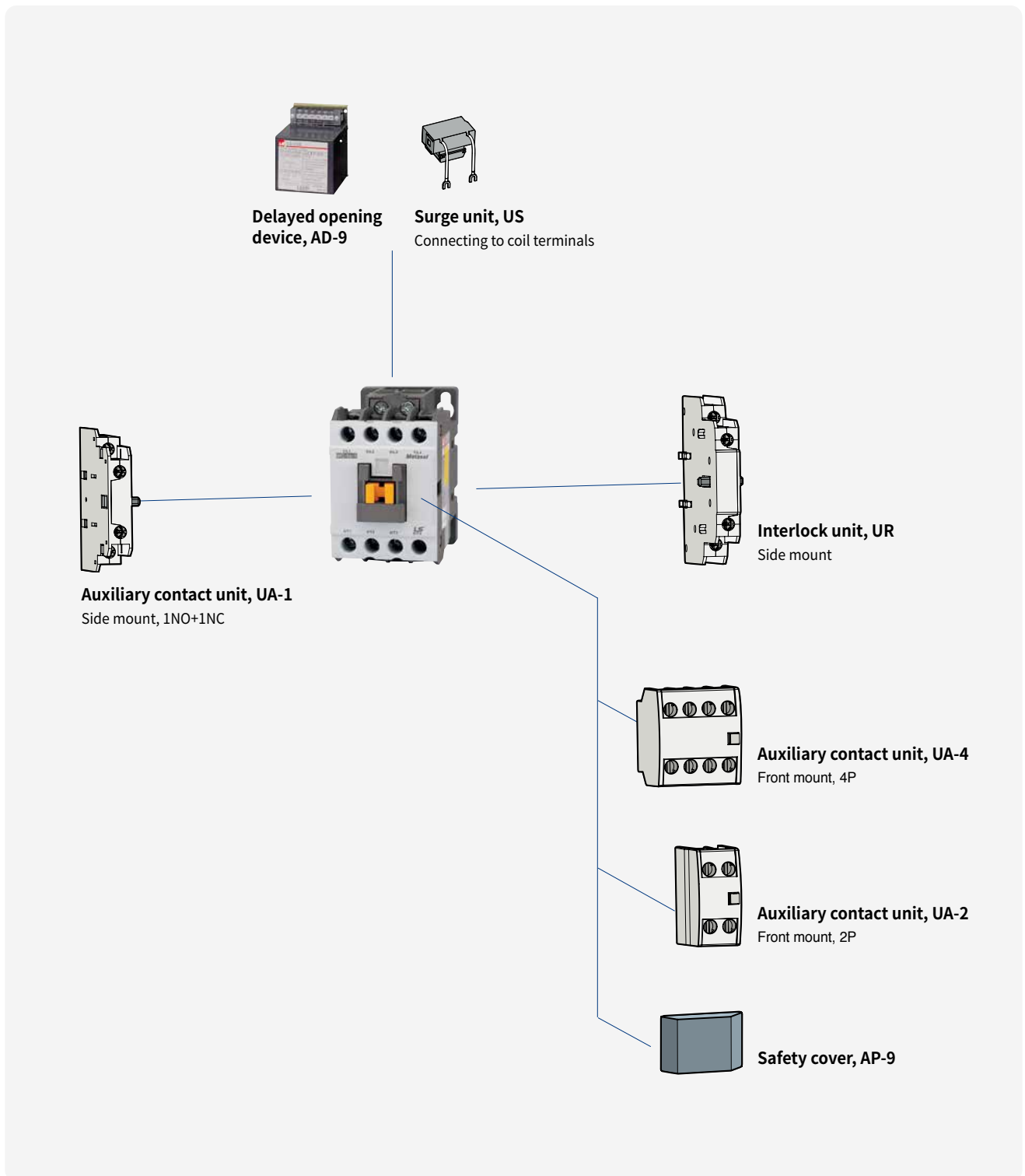

4-pole contactors

Description 22, 40AF

- 4-pole main contact
- Finger proof design
- DIN rail or screw mountable
- Auxiliary contacts are optional
- Front/side mountable accessories
- Direct mountable overload relays available
- Degree of protection: IP20

Rating

Contactor type			MC-22a/4		MC-32a/4		MC-40a/4		
			kW	A	kW	A	kW	A	
AC duty	AC1	200/240V	15	40	18	50	22	60	
		380/440V	27	40	35	50	42	60	
		500/550V	35	40	43	50	52	60	
		690V	44	40	55	50	66	60	
	AC3	200/240V	5.5	22	7.5	32	11	40	
		380/440V	11	22	15	32	18.5	40	
		lth	-	40	-	50	-	60	
DC1 duty (L/R=1ms)	2-pole in series	110V	-	15	-	25	-	25	
		220V	-	10	-	12	-	12	
	3-pole in series	110V	-	20	-	25	-	35	
		220V	-	20	-	22	-	30	
	4-pole in series	110V	-	30	-	32	-	40	
		220V	-	25	-	30	-	35	
UL rating			hp	A	hp	A	hp	A	
			220/240V	7.5	-	10	-	10	-
			440/480V	10	-	20	-	25	-
			550/600V	15	-	20	-	25	-
			lth	-	32	-	45	-	50
Conductor size (Solid, stranded) (The max. number of conducts: 2)		AWG	12~8		10~6		8~6		
		mm ²	2.5~10		4~16		10~16		
Conductor type			65/75°C Cu-wire only						



MC-22a/4



MC-40a/4

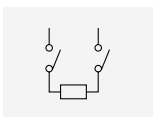

2pole for DC contact

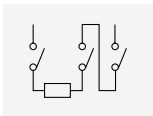

3pole for DC contact

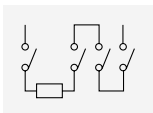

4pole for DC contact



Coil voltage

AC	50Hz	24, 36, 42, 48, 65, 80, 100, 110, 220, 230, 240, 380, 400, 415, 440, 500, 550, 240(wide)V
	60Hz	24, 48, 110, 208, 220, 240, 277, 380, 440, 480, 600V
	50/60Hz	24, 48, 100, 110, 120, 200, 220, 230, 240, 380, 400, 415, 440, 500, 550V
DC		12, 20, 24, 48, 60, 80, 100, 110, 125, 200, 220, 250V

Certification

- CE(IEC)
- UL508
- CCC

Accessories

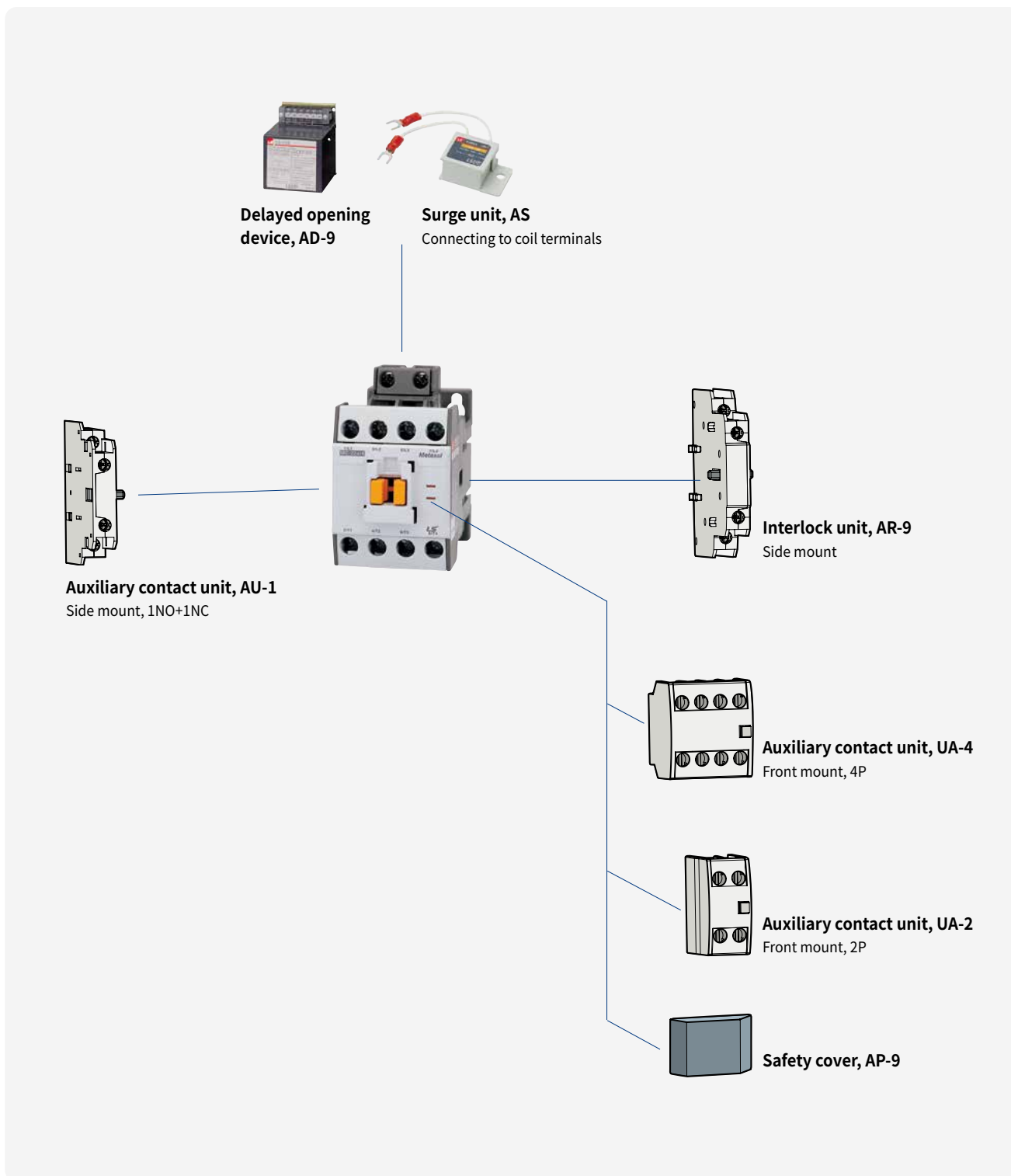

4-pole contactors

Description 85AF

- 4-pole main contact
- Finger proof design
- DIN rail or screw mountable
- Auxiliary contacts are optional
- Front/side mountable accessories
- Direct mountable overload relays available
- Degree of protection: IP20



MC-85a/4

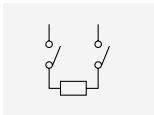

2pole for DC contact

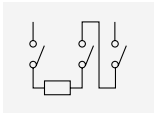

3pole for DC contact

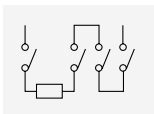

4pole for DC contact

Rating

Contactor type			MC-50a/4		MC-65a/4		MC-75a/4		MC-85a/4	
			kW	A	kW	A	kW	A	kW	A
AC duty	AC1	200/240V	30	80	37	100	41	110	51	135
		380/440V	56	80	70	100	76	110	95	135
		500/550V	70	80	88	100	97	110	120	135
		690V	88	80	110	100	120	110	150	135
	AC3	200/240V	15	55	18.5	65	22	75	25	85
		380/440V	22	50	30	65	37	75	45	85
		lth	-	80	-	100	-	110	-	135
DC1 duty (L/R=1ms)	2-pole in series	110V	-	35	-	35	-	50	-	50
		220V	-	15	-	15	-	20	-	20
	3-pole in series	110V	-	50	-	65	-	75	-	80
		220V	-	40	-	50	-	55	-	60
	4-pole in series	110V	-	60	-	70	-	80	-	100
		220V	-	50	-	60	-	70	-	70
UL rating			hp	A	hp	A	hp	A	hp	A
Conductor size (Solid, stranded)			AWG		6~3		4~2		4~2	
(The max. number of conducts: 2)			mm ²		16~35		25~35		25~50	
Conductor type			65/75°C Cu-wire only							



Coil voltage

AC	50Hz	24, 48, 100, 110, 200, 220, 230, 240, 380, 400, 415, 440, 500, 550V, 240(wide)
	60Hz	24, 48, 110, 120, 208, 220, 240, 277, 380, 440, 480, 600V
	50/60Hz	24, 48, 110, 120, 220, 230, 240, 380, 400, 415, 440, 500, 550V
DC		12, 20, 24, 48, 60, 80, 100, 110, 125, 200, 220, 250V

Certification

- CE(IEC)
- UL508
- CCC

Accessories

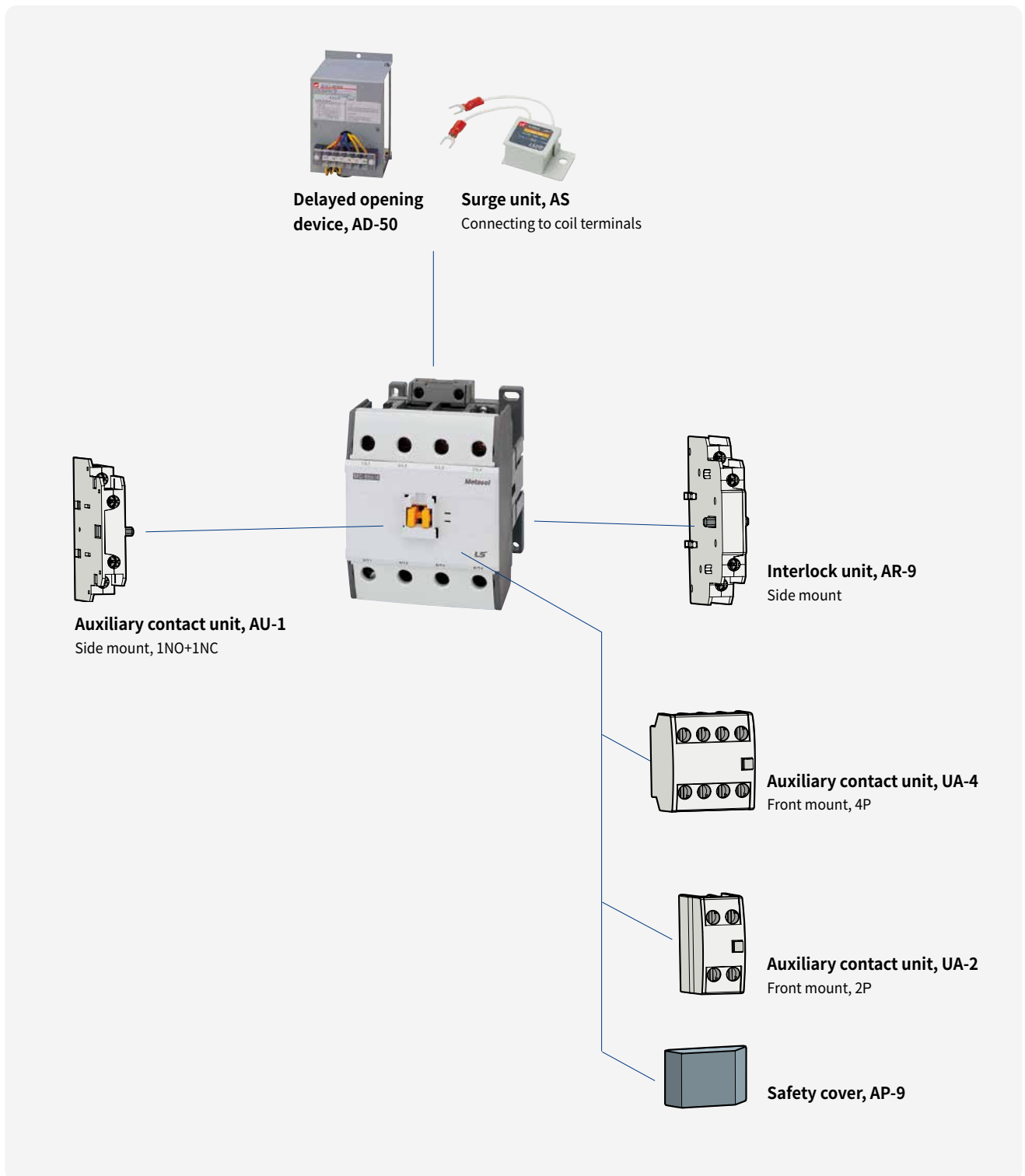

4-pole contactors

Description 225AF

- 4-pole main contact
- AC/DC common use coil built
- Wide coil operation voltage
- Screw mountable
- 2NO+2NC auxiliary contacts built-in as standard
- Side mountable accessories
- Direct mountable overload relays available
- Degree of protection: IP20

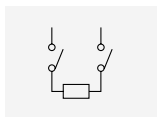

2pole for DC contact

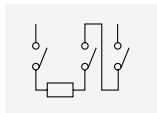

3pole for DC contact

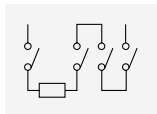

4-pole in series

Rating

Contactor type			MC-100a/4		MC-130a/4		MC-150a/4		MC-185a/4		MC-225a/4		
			kW	A	kW	A	kW	A	kW	A	kW	A	
AC duty	AC1	200/240V	57	200	60	250	76	275	87	300	100	350	
		380/440V	106	200	110	250	142	275	165	300	185	350	
		500/550V	132	200	137	250	180	275	205	300	230	350	
		690V	165	200	170	250	225	275	255	300	290	350	
	AC3	200/240V	30	105	37	125	45	150	55	185	75	225	
		380/440V	55	105	60	120	75	150	90	185	132	225	
		Ith	-	200	-	250	-	275	-	300	-	350	
		75°C Cu stranded wire											
DC1 duty (L/R=1ms)	2-pole in series	110V	-	80	-	80	-	100	-	150	-	150	
		220V	-	50	-	50	-	100	-	150	-	150	
	3-pole in series	110V	-	100	-	100	-	150	-	180	-	220	
		220V	-	80	-	80	-	150	-	180	-	220	
	4-pole in series	110V	-	100	-	100	-	150	-	180	-	220	
		220V	-	90	-	100	-	150	-	180	-	220	
UL rating			hp	A	hp	A	hp	A	hp	A	hp	A	
			220/240V	30	-	40	-	50	-	60	-	75	-
			440/480V	60	-	75	-	100	-	125	-	150	-
			550/600V	60	-	75	-	100	-	125	-	150	-
			Ith	-	200	-	250	-	275	-	300	-	350
Conductor size (Solid, stranded)			AWG	6~00		3~00		3~4/0		1~4/0		0~300	
(The max. number of conducts: 2)			mm ²	16~70		35~70		35~95		50~95		50~150	
Conductor type			75°C Cu stranded wire										



Coil voltage, AC/DC common

Nominal(Ordering) voltage	AC 50/60Hz	DC
24V	24 - 25V	24V
48V	48 - 50V	48V
100/200V	100 - 240V	100 - 220V
300V	265 - 347V	-
400V	380 - 450V	-
500V	440 - 575V	-

Certification

- CE(IEC)
- UL508
- CCC

Accessories

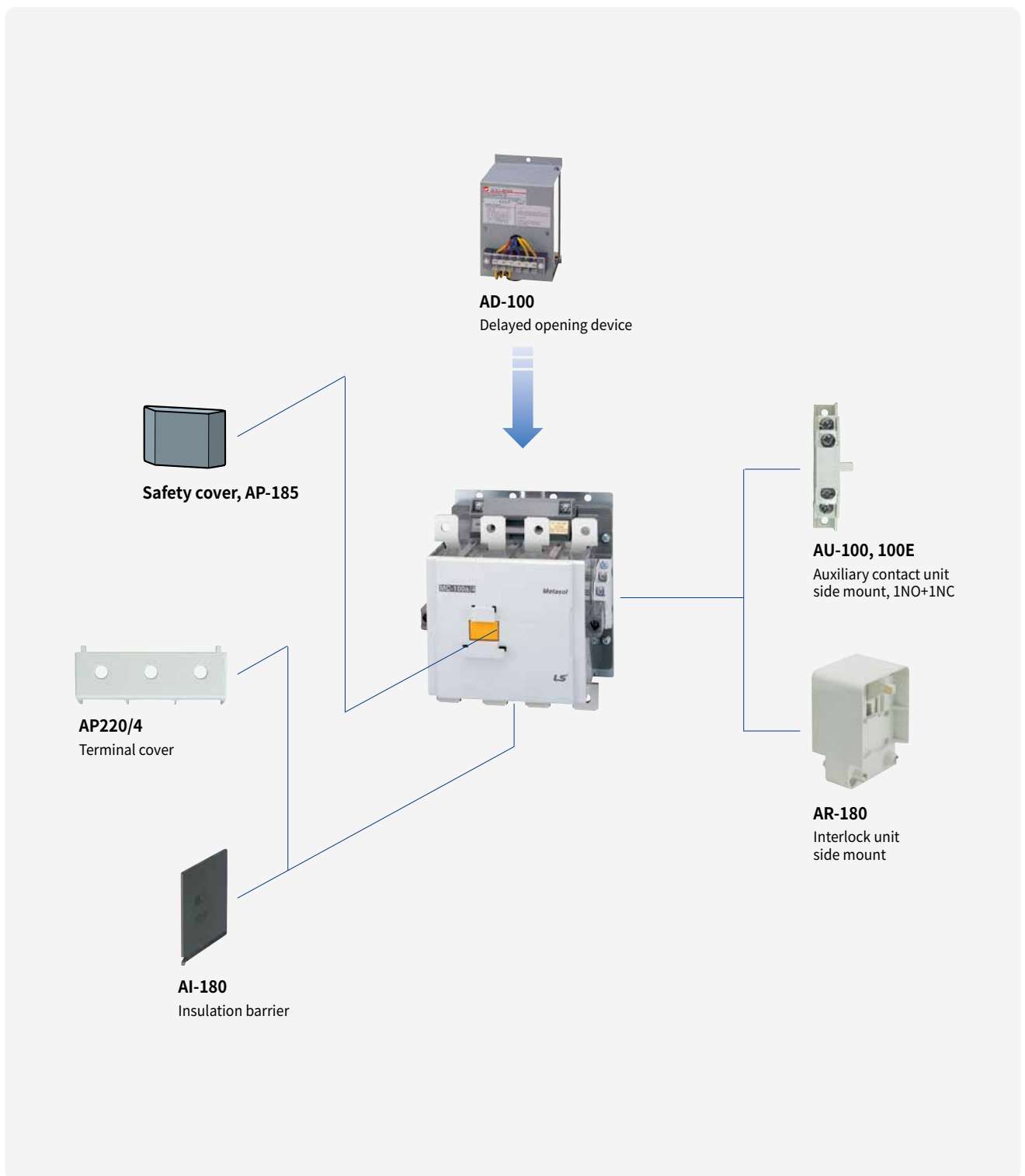

4-pole contactors

Description 400AF

- 4-pole main contact
- AC/DC common use coil built
- Wide coil operation voltage
- Screw mountable
- 2NO+2NC auxiliary contacts built-in as standard
- Side mountable accessories
- Degree of protection: IP20



MC-400a/4

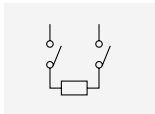

2pole for DC contact

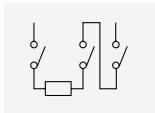

3pole for DC contact

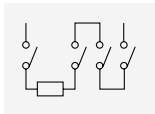

4pole for DC contact

Rating

Contactor type			MC-265a/4		MC-330a/4		MC-400a/4		
			kW	A	kW	A	kW	A	
AC duty	AC1	200/240V	115	400	135	500	160	520	
		380/440V	215	400	250	500	300	520	
		500/550V	265	400	315	500	375	520	
		690V	335	400	390	500	470	520	
	AC3	200/240V	80	265	90	330	125	400	
		380/440V	147	265	160	330	200	400	
		Ith	-	400	-	500	-	520	
DC1 duty (L/R=1ms)	2-pole in series	110V	-	150	-	200	-	200	
		220V	-	150	-	200	-	200	
	3-pole in series	110V	-	220	-	300	-	400	
		220V	-	220	-	300	-	300	
	4-pole in series	110V	-	220	-	300	-	400	
		220V	-	220	-	300	-	300	
UL rating			hp	A	hp	A	hp	A	
			220/240V	100	-	100	-	150	-
			440/480V	200	-	200	-	300	-
			550/600V	200	-	200	-	300	-
			Ith	-	400	-	500	-	520
Conductor size (Solid, stranded) (The max. number of conducts: 2)		AWG	3/0~500		4/0~500		350~700		
		mm ²	95~240		95~240		185~370		
Conductor type			75°C Cu stranded wire						



Coil voltage, AC/DC common

Nominal(Ordering) voltage	AC 50/60Hz	DC
100/200V	100 - 240V	100 - 220V
300V	265 - 347V	-
400V	380 - 450V	-
500V	440 - 575V	-

Certification

- CE(IEC)
- UL508
- CCC

Accessories

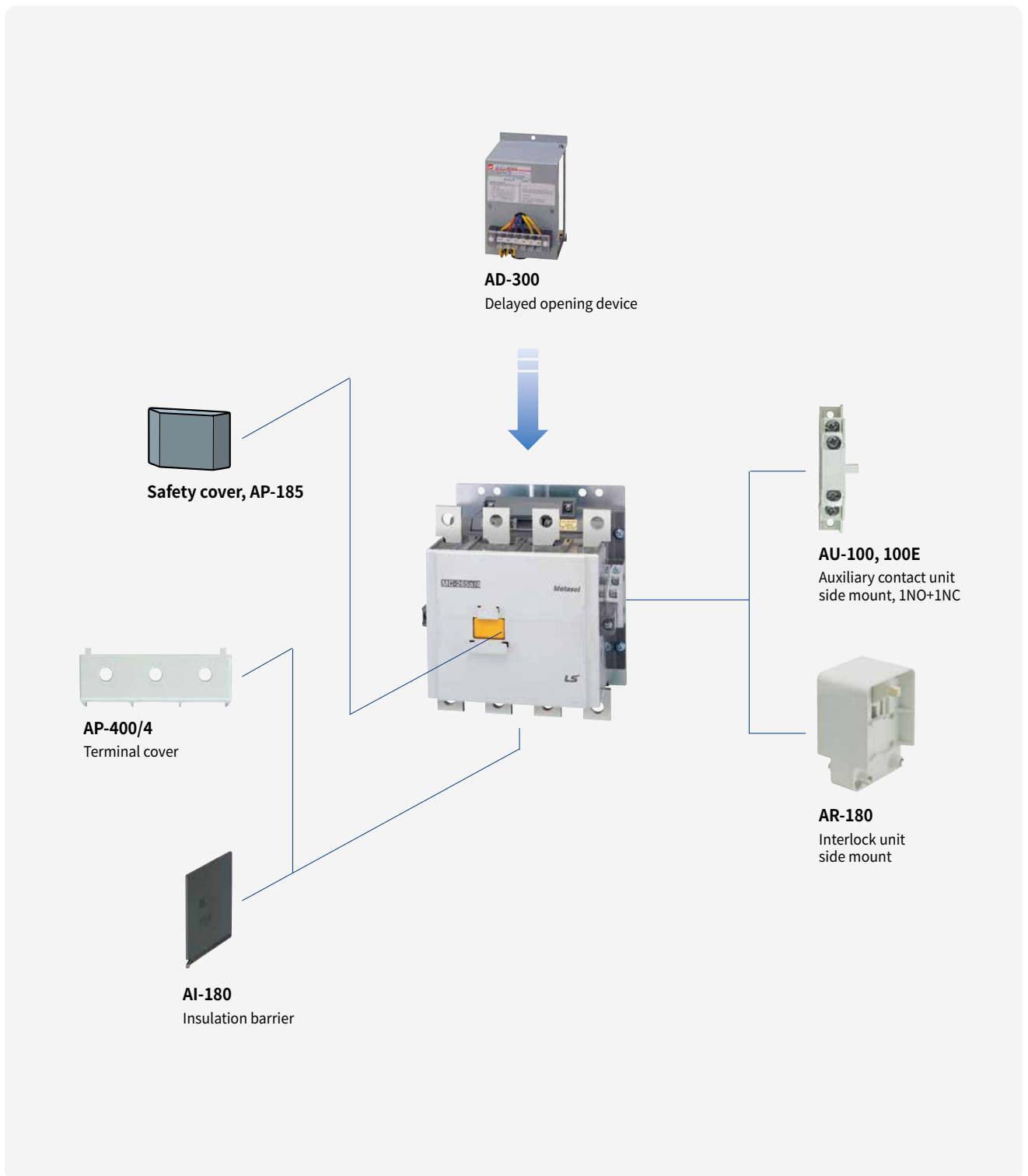

4-pole contactors

Description 800AF

- 4-pole main contact
- AC/DC common use coil built
- Wide coil operation voltage
- Screw mountable
- 2NO+2NC auxiliary contacts built-in as standard
- Side mountable accessories
- Degree of protection: IP20



MC-800a/4

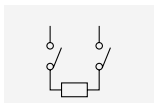

2pole for DC contact

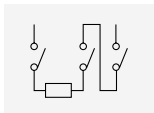

3pole for DC contact

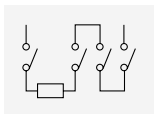

4pole for DC contact

Rating

Contactor type			MC-500a/4		MC-630a/4		MC-800a/4	
			kW	A	kW	A	kW	A
AC duty	AC1	200/240V	245	700	255	900	310	1050
		380/440V	450	700	470	900	570	1050
		500/550V	560	700	590	900	710	1050
		690V	710	700	740	900	900	1050
	AC3	200/240V	147	500	190	630	220	800
		380/440V	265	500	330	630	440	800
	Ith	-	700	-	900	-	1050	
DC1 duty (L/R=1ms)	2-pole	110V	-	200	-	630	-	630
		220V	-	200	-	630	-	630
	3-pole	110V	-	400	-	630	-	800
		220V	-	300	-	630	-	800
	4-pole	110V	-	400	-	630	-	800
		220V	-	300	-	630	-	800
UL rating			hp	A	hp	A	hp	A
		220/240V	200	-	250	-	300	-
		440/480V	400	-	500	-	600	-
		550/600V	400	-	500	-	600	-
		Ith	-	700	-	900	-	1050
Conductor size (Solid, stranded) (The max. number of conducts: 2)		AWG	350~800		600~2000		1700~Busbar	
		mm ²	185~480		-		-	
Conductor type			75°C Cu stranded wire					



Coil voltage, AC/DC common

Nominal(Ordering) voltage	AC 50/60Hz	DC
100V	100 - 127V	100 - 220V
200V	200 - 240V	200 - 220V
300V	265 - 347V	-
400V	380 - 450V	-
500V	440 - 575V	-

Certification
<ul style="list-style-type: none"> • CE(IEC) • UL508 • CCC

Accessories

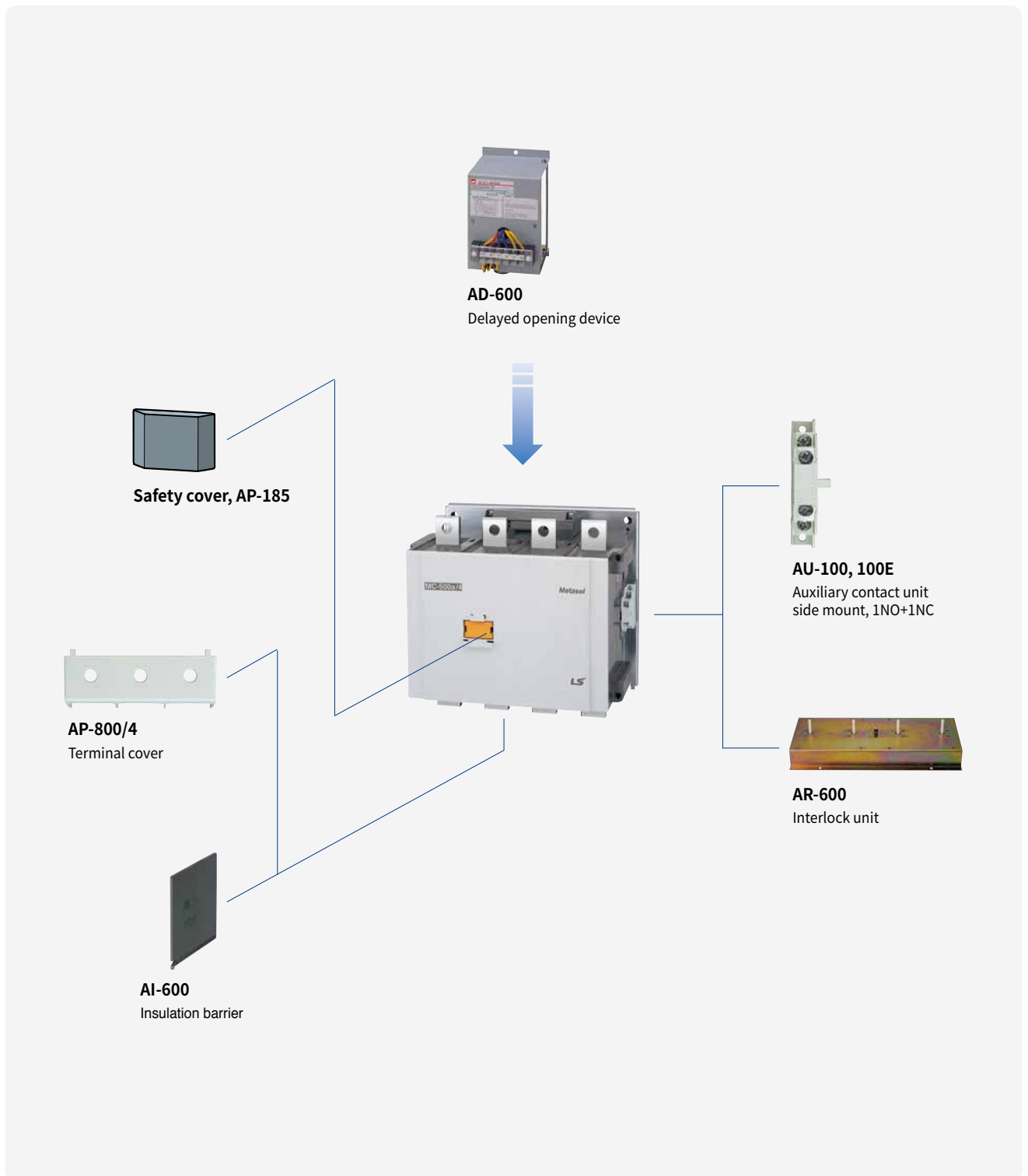

Enclosed motor starters, Mold enclosure

Description

- Enclosed & full voltage type
 - MW-□bM: Plastic enclosure without buttons
 - MW-□bMB: Plastic enclosure with ON/OFF buttons
- With differential or non-differential type thermal overload relay
- Contactors: 3 pole with AC coil
- Screw mountable
- Degree of protection: IP40

Rating



Type	AC3 Ratings (IEC 60947-4-1)				Auxiliary contact (standard)	Devices combined	
	220~240V	380~440V	500~550V	690V		Contactor	Overload relay
MW-9bM(B)	2.5kW 11A	4kW 9A	4kW 7A	4kW 6A	1NO1NC	MC-9b	MT-32 (0.1-22A)
MW-12bM(B)	3.5kW 13A	5.5kW 12A	7.5kW 12A	7.5kW 9A		MC-12b	
MW-18bM(B)	4.5kW 18A	7.5kW 18A	7.5kW 13A	7.5kW 9A		MC-18b	
MW-22bM(B)	5.5kW 22A	11kW 22A	15kW 20A	15kW 18A		MC-22b	



Overload relay setting range, Amp.

MT-12		MT-32		MT-63		MT-95	
0.1 - 0.16	5 - 8	0.1 - 0.16	5 - 8	4 - 6	28 - 40	7 - 10	54 - 75
0.16 - 0.25	6 - 9	0.16 - 0.25	6 - 9	5 - 8	34 - 50	9 - 13	63 - 85
0.25 - 0.4	7 - 10	0.25 - 0.4	7 - 10	6 - 9	45 - 65	12 - 18	70 - 95
0.4 - 0.63	9 - 13	0.4 - 0.63	9 - 13	7 - 10		16 - 22	80 - 100
0.63 - 1	12 - 18	0.63 - 1	12 - 18	9 - 13		18 - 25	
1 - 1.6		1 - 1.6	16 - 22	12 - 18		24 - 36	
1.6 - 2.5		1.6 - 2.5	18 - 25	16 - 22		28 - 40	
2.5 - 4		2.5 - 4	22 - 32	18 - 25		34 - 50	
4 - 6		4 - 6	28 - 40	24 - 36		45 - 65	



Internal device



Coil voltage

AC	50Hz	24, 32, 42, 48, 80, 100, 110, 220, 230, 240, 380, 400, 500, 550V
	60Hz	24, 48, 100, 110, 120, 200, 208, 220, 230, 240, 277, 380, 480, 600V

Certification
• CE(IEC) • UL508

Type numbering system

MW-6a	/	B	/	2H
Rated current		Enclosure type		Thermal overload relay version
6a 6A		- Without push button (Steel enclosure)		2H Non-differential(2-heater)
⋮		B With push button (Steel enclosure)		3H Non-differential(3-heater)
100a 100A		M Without push button (Mold enclosure)		3K Differential
		MB With push button (Mold enclosure)		3D Class 20

Description

- Full voltage type
MW-□a/MW-□b: Steel enclosure without buttons
MW-□aB/MW-□bB: Steel enclosure ON/OFF buttons
- Contactors: 3 pole with AC coil
- Overload relay with differential or non-differential type
- Screw mountable
- Degree of protection: IP40

Rating



Internal device

Type	AC3 Ratings (IEC 60947-4-1)					Devices combined	
	220~240V	380~440V	500~550V	690V	1000V	Contactor	Overload relay
MW-6a(B)	2.2kW 9A	3kW 7A	3kW 6A	3kW 4A	-	MC-6a	MT-12 (0.1~18A)
MW-9a(B)	2.5kW 11A	4kW 9A	4kW 7A	4kW 5A	-	MC-9a	
MW-12a(B)	3.5kW 13A	5.5kW 12A	7.5kW 12A	7.5kW 9A	-	MC-12a	
MW-18a(B)	4.5kW 18A	7.5kW 18A	7.5kW 13A	7.5kW 9A	-	MC-18a	
MW-9b(B)	2.5kW 11A	4kW 9A	4kW 7A	4kW 6A	-	MC-9b	MT-32 (0.1~22A)
MW-12b(B)	3.5kW 13A	5.5kW 12A	7.5kW 12A	7.5kW 9A	-	MC-12b	
MW-18b(B)	4.5kW 18A	7.5kW 18A	7.5kW 13A	7.5kW 9A	-	MC-18b	
MW-22b(B)	5.5kW 22A	11kW 22A	15kW 20A	15kW 18A	-	MC-22b	
MW-32a(B)	7.5kW 32A	15kW 32A	18.5kW 28A	18.5kW 20A	22kW 17A	MC-32a	MT-32 (0.1~40A)
MW-40a(B)	11kW 40A	18.5kW 40A	22kW 32A	22kW 23A	22kW 17A	MC-40a	
MW-50a(B)	15kW 55A	22kW 50A	30kW 43A	30kW 28A	30kW 23A	MC-50a	MT-63 (4~65A)
MW-65a(B)	18.5kW 65A	30kW 65A	33kW 60A	33kW 35A	30kW 23A	MC-65a	
MW-75a(B)	22kW 75A	37kW 75A	37kW 64A	37kW 42A	37kW 28A	MC-75a	MT-95 (7~100A)
MW-85a(B)	25kW 85A	45kW 85A	45kW 75A	45kW 45A	37kW 28A	MC-85a	
MW-100a(B)	30kW 105A	55kW 105A	55kW 85A	55kW 65A	37kW 28A	MC-100a	

Overload relay setting range, Amp.

MT-12		MT-32		MT-63		MT-95	
0.1 - 0.16	5 - 8	0.1 - 0.16	5 - 8	4 - 6	28 - 40	7 - 10	54 - 75
0.16 - 0.25	6 - 9	0.16 - 0.25	6 - 9	5 - 8	34 - 50	9 - 13	63 - 85
0.25 - 0.4	7 - 10	0.25 - 0.4	7 - 10	6 - 9	45 - 65	12 - 18	70 - 95
0.4 - 0.63	9 - 13	0.4 - 0.63	9 - 13	7 - 10		16 - 22	80 - 100
0.63 - 1	12 - 18	0.63 - 1	12 - 18	9 - 13		18 - 25	
1 - 1.6		1 - 1.6	16 - 22	12 - 18		24 - 36	
1.6 - 2.5		1.6 - 2.5	18 - 25	16 - 22		28 - 40	
2.5 - 4		2.5 - 4	22 - 32	18 - 25		34 - 50	
4 - 6		4 - 6	28 - 40	24 - 36		45 - 65	



Coil voltage

AC	50Hz	24, 32, 42, 48, 80, 100, 110, 220, 230, 240, 380, 400, 500, 550V
	60Hz	24, 48, 100, 110, 120, 200, 208, 220, 230, 240, 277, 380, 480, 600V

Certification
• CE(IEC) • UL508

Capacitor contactors

Description

- Capacitor unit (Pre-loading resistor) is connected to the terminals of the contactor to reduce the high inrush current exceeding $20 \times I_n$.
- AC control coil on selection
- 3-pole (NO) main contact
- DIN rail or screw mountable
- IEC 60947-4-1 AC 6b
- Finger proof design

Rating

Type	Rating (kVar, A)			
	220~240V	400~440V	500~550V	600~690V
MC-9b with AC-9	5kVar	9.7kVar	14kVar	16kVar
	13A	14A	16A	15A
MC-12b with AC-9	6.7kVar	12.5kVar	18kVar	18kVar
	18A	18A	21A	17A
MC-18b with AC-9	8.5kVar	16.7kVar	24kVar	26kVar
	22A	24A	28A	25A
MC-22b with AC-9	10kVar	18kVar	26kVar	30kVar
	26A	26A	30A	29A
MC-32a with AC-9	15kVar	25kVar	36kVar	40kVar
	39A	36A	42A	38A
MC-40a with AC-9	20kVar	33.3kVar	48kVar	53kVar
	52A	48A	55A	51A
MC-50a with AC-50	20kVar	40kVar	58kVar	65kVar
	52A	58A	67A	63A
MC-65a with AC-50	25kVar	45.7kVar	66kVar	73kVar
	66A	66A	76A	70A
MC-75a with AC-75	29.7kVar	54kVar	78kVar	85kVar
	78A	78A	90A	82A
MC-85a with AC-75	35kVar	60kVar	92kVar	100kVar
	92A	87A	106A	96A
MC-100a with AC-75	37kVar	62kVar	94kVar	105kVar
	97A	89A	109A	101A

Type	Rating (kVar, A)	
	500~550V	600~690V
MC-9b	4kVar	3.5kVar
	4.6A	3.4A
MC-12b	4kVar	4kVar
	4.6A	3.8A
MC-18b	5kVar	4.5kVar
	5.8A	4.3A
MC-22b	8kVar	8kVar
	9.2A	7.7A
MC-32a	17kVar	14kVar
	20A	13A
MC-40a	25kVar	18kVar
	29A	17A
MC-50a	30kVar	25kVar
	35A	24A
MC-65a	40kVar	35kVar
	46A	34A
MC-75a	50kVar	40kVar
	58A	38A
MC-85a	55kVar	45kVar
	64A	43A
MC-100a	60kVar	48kVar
	69A	46A
MC-130a	70kVar	60kVar
	81A	58A
MC-150a	90kVar	78kVar
	104A	75A
MC-185a	120kVar	100kVar
	139A	96A
MC-225a	130kVar	105kVar
	150A	101A
MC-265a	140kVar	115kVar
	162A	111A
MC-330a	185kVar	140kVar
	214A	135A
MC-400a	195kVar	160kVar
	225A	154A
MC-500a	330kVar	290kVar
	381A	279A
MC-630a	340kVar	300kVar
	393A	289A
MC-800a	370kVar	320kVar
	427A	308A



- Note) 1. When the switch is closed condenser must be discharged before recharged. (Maximum residual voltage at terminals $\leq 50V$)
 2. To prevent short current, gG type fuse must be 1.5-2 times than rated current.



Coil voltage

AC	50Hz	24, 32, 42, 48, 80, 100, 110, 220, 230, 240, 380, 400, 500, 550V
	60Hz	24, 48, 100, 110, 120, 200, 208, 220, 230, 240, 277, 380, 480, 600V

- These capacitive contactors are suitable for switching single-step or multiple-step condenser bank.
- It is standardized by IEC-60947-4941, UL and CSA.
- Features of capacitor unit (Pre-loading resistor)
 - Damping resistor that can limit the inrush current upto $60 \times I_n$ is connected to the mechanism that closed earlier than the main contact of the contactor
 - No heat loss by the serial resistor
 - Eliminate the switching surge
 - Improving the performance of the capacitor system

Example

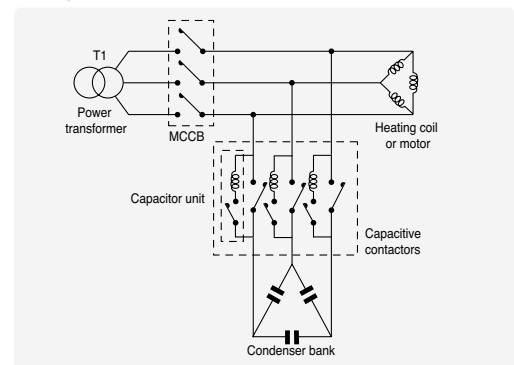

Description

- Two normally open main contacts
- Screw clamp or fast-on connections
- Small and light design suitable for use in air conditioners, heaters, refrigerators, etc.
- Screw mountable
- No auxiliary contact
- AC control voltage

Rating

Type	AC3 ratings			I _{th}	Contact	
	220~240V	380~440V	500~550V		NO	NC
GMC-10P2	10A	8A	6A	20A	2	-
GMC-20P2	20A	17A	14A	30A	2	-
GMC-25P2	25A	21A	17A	35A	2	-
GMC-30P2	30A	23A	21A	40A	2	-
GMC-35P2	35A	26A	23A	45A	2	-
GMC-40P2	40A	32A	26A	50A	2	-

Insulation voltage: 690V at AC, 250V at DC

Control coil characteristics

Coil voltage	Coil consumption (VA)		Thermal dissipation (W)	Operational voltage (V)		Coil current (mA)	Operational time (ms)	
	Inrush	Holding		Pick-up	Drop-out		Closing	Opening
24V 50/60Hz	35	6.0	2	83% or less of coil voltage	More than 20% of coil voltage	263	40	30
48V 50/60Hz	35	6.0	2			131	40	30
100V 50/60Hz	35	6.0	2			63	40	30
110V 50/60Hz	35	6.0	2			57	40	30
120V 50/60Hz	35	6.0	2			53	40	30
200V 50/60Hz	35	6.0	2			32	40	30
220V 50/60Hz	35	6.0	2			29	40	30
230V 50/60Hz	35	6.0	2			27	40	30
240V 50/60Hz	35	6.0	2			26	40	30

Note) 1. The condition of the above data: 60Hz, 20°C from cold state

2. Coil consumption (VA) is average value.



Main terminal

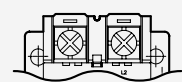

Screw clamp

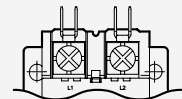

Fast-on (Quick connect)

Coil terminal

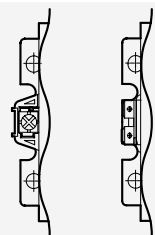

Screw clamp

Fast-on (Quick connect)

Type numbering system

GMC	10P	2	TS	BQ	100V
Contactors	Capacity (A)	Pole	Main terminal connect	Power supply connect	Operation voltage (AC)
	10P 10	2 2pole	TS Screw clamp	BS Screw clamp	20V 24V
	20P 20		TQ Quick connect	BQ Quick connect	48V 24~240
	25P 25				110V 100~120V
	30P 30				220V 208~240V
	35P 35				
	40P 40				

3-pole AC contactors, Definite purpose

Description

- Three main contacts
- Screw clamp connections
- Small and light design suitable for use in air conditioners, heaters, refrigerators, etc.
- Screw mountable
- No auxiliary contact
- AC control voltage



Rating

Type	AC3 ratings			AC4 ratings			Ith	Contact	
	220~240V	380~440V	500~550V	220~240V	380~440V	500~550V		NO	NC
GMC-20D2 GMC-20D3	20A	17A	14A	18A	13A	10A	30A	2	-
								3	-
								2	1
GMC-25D2 GMC-25D3	25A	21A	17A	20A	14A	12A	35A	2	-
								3	-
								2	1

Note) Above contact ratings are for NO contact.
 Rating for NC contact: 6A@120V, 3A@240V, 1.5A@480V at AC15 duty
 Rating above 24V 1A
 Please use NC contact for Insulation voltage: 690V at AC, 250V at DC

Control coil characteristics

Coil voltage	Coil consumption (VA)		Thermal dissipation (W)	Operational voltage(V)		Coil current (mA)	Operational time (ms)	
	Inrush	Holding		Pick-up	Drop-out		Closing	Opening
24V 60Hz	72	9.0	3	83% or less of coil voltage	More than 20% of coil voltage	215	30	20
48V 60Hz	72	9.0	3			125	30	20
110V 60Hz	72	9.0	3			60	30	20
220V 60Hz	72	9.0	3			41	30	20

Note) 1. The condition of the above data: 60Hz, 20°C from cold state
 2. Coil consumption (VA) is average value.

Type numbering system

GMC	/	20	D2	2NO1NC	AC 220V
Contactors		Rated current	Pole	Auxiliary contact	Operation voltage (AC)
		20	D2	2pole: 2NO	20V
		25	D3	3pole: 3NO	48V
				2NO 1NC	110V
					220V

Description

- Single-pole NO main contact
- Small and light design suitable for use in electric shock protector for AC arc welder
- DIN rail or screw mountable
- No auxiliary contact (Optional unit can be added up to 2NO2NC)
- AC control voltage



Rating

Type	Rated current, In 110/220V	Ith	Performance	
			Making current	Breaking current
MC-65aSP	220A	500A	1.5×In	

Control coil characteristics

Coil consumption (VA)		Operational voltage		Operational time
Inrush	Holding	Pick-up	Drop-out	Closing
150VA	17VA	85% under	20% over	30ms under

Note) Coil voltage is available between AC24V and AC550V

2-pole DC contactors

Description

- Two normally open main contacts for DC circuit
- Positive and negative poles indicated on the front plate
- Eternal magnet installed for the effective arc extinguishing
- DIN rail or screw mountable
- 2NO+2NC Auxiliary contacts built-in as standard
- AC/DC control voltage



Selection

Contactor Type	DC-3, 5 ratings			DC-1 rating	Continuous current, I _{th}	Auxiliary contacts
	125V	250V	500V	1000V		
MD-30a	40A	30A	20A	10A	60A	2a(NO)+2b(NC)
MD-60a	80A	60A	40A	25A	100A	2a(NO)+2b(NC)
MD-100a	120A	100A	60A	35A	135A	2a(NO)+2b(NC)



Ratings of auxiliary contacts

UA-1	AC15 duty						DC13 duty				
	120V	240V	380V	480V	500V	600V	125V	250V	400V	500V	600V
Rated currents	6A	3A	1.9A	1.5A	1.4A	1.2A	1.1A	0.55A	0.31A	0.27	0.2A
Continuous current, I _{th}	16A										



Coil voltage

AC	50/60Hz	24, 48, 100, 110, 120, 200, 220, 230, 240, 380, 400, 415, 440, 500, 550V
DC		12, 20, 24, 48, 60, 80, 100, 110, 125, 200, 220, 250V

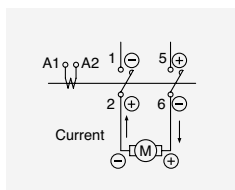

Auxiliary contact units

- 2 and 4 pole
- Side and front mountable
- Common use for Metasol contactors from MC-6a to MC-150a, and from MC-6a/4 to 85a/4
- Auxiliary contact meet the requirements for mirror contacts in IEC 60947-4-1. Annex F (A mirror contact is an auxiliary NC contact that cannot be closed simultaneously with a NO main contact)

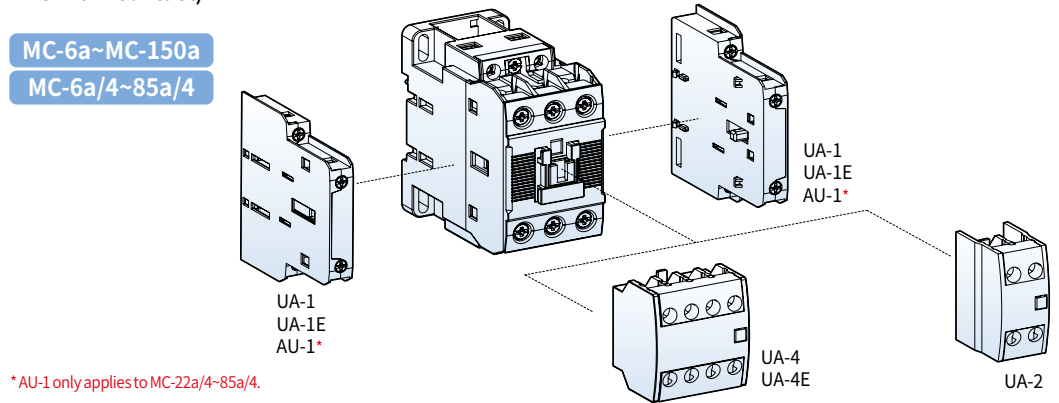

Selection

Type	Appearance	Pole	Composition		Contact arrangement	Mount	Weight
			No	Nc			
UA-1 UA-1E AU-1		2	1	1	<p>13(43) 21(31) 14(44) 22(32)</p>	Side	53g
UA-2		2	2 1 -	- 1 2	<p>53 63 51 63 51 61 54 64 52 64 52 62 2a 1a1b 2b</p>	Front	28g
UA-4 UA-4E		4	4 3 2 1 -	- 1 2 3 4	<p>53 63 73 83 53 61 73 83 53 61 71 83 54 64 74 84 54 62 74 84 54 62 72 84 4a 3a1b 2a2b 51 63 71 81 51 61 71 81 52 64 72 82 52 62 72 82 1a3b 4b</p>	Front	50g

*UA-1 auxiliary contact can not be attached to the right side of 22AF product

Maximum combination of contact units

MC-6a~18a, 9b~22b (Max. 3a3b)	MC-32a~150a (Max. 4a4b)
UA-4(on front)+UA-1×1EA (1EA on one side)	UA-4(on front)+UA-1×2EA (1EA on both sides)
UA-2(on front)+UA-1×1EA (1EA on one side)	UA-2(on front)+UA-1×2EA (1EA on both sides)
UA-1×2EA (1EA on both sides)	UA-1×4EA (2EA on both sides) *For AC Coil

*MC-6a~18a, 9b~22b DC type (Max. 2a2b)

Auxiliary contact units

- 2 pole
- Side mountable
- Auxiliary contact meet the requirements for mirror contacts in IEC 60947-4-1. Annex F
(A mirror contact is an auxiliary NC contact that cannot be closed simultaneously with a NO main contact)



Selection

Type	Appearance	Pole	Composition		Contact arrangement	Mount	Weight
			a(NO)	b(NC)			
AU-100 AU-100E		2	1	1		Side	53g

Maximum combination of contact units

MC-185a~2650a (Max. 4a4b)

AU-100 × 4EA (2EA on both sides)

AU-100E × 4EA (2EA on both sides)

Installation

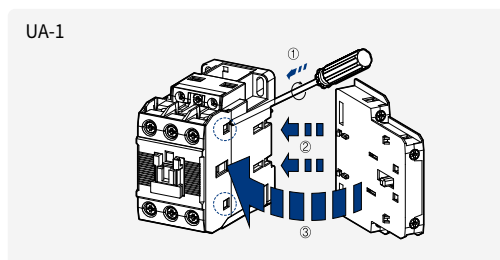

To install side mounting unit remove the indicated part in the circle in the fig. first. And then fit each part as shown. To separate push forward and pull.

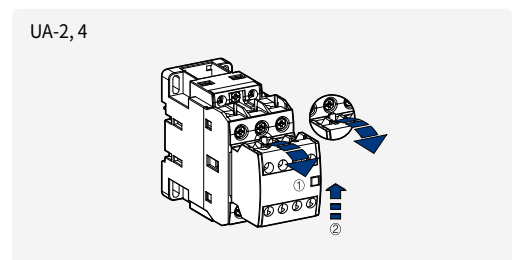

To install front mounting unit fit it on the upper part of the front of the contactor and push it down. To separate pull the lever of the unit and push the unit upward.

Rating

Type		UA-1	AU-1	UA-2, 4	AU-100
Rated operation voltage	(Ue)	600V	600V	600V	600V
Rated insulation voltage	(Ui)	1000V	690V	690V	600V
Rated impulse withstand voltage	(Uimp)	8kV	8kV	6kV	6kV
Rated frequency		50/60Hz	50/60Hz	50/60Hz	50/60Hz
Contact sensibility	Voltage	DC 24V	DC 24V	DC 24V	DC 24V
	Current	DC 10mA	DC 10mA	DC 10mA	DC 10mA
Rated thermal current (Ith, AC12 duty)		16A	16A	16A	16A
Rated operation current	AC15 duty	120V	6A	6A	6A
		240V	3A	3A	3A
		380V	1.9A	1.9A	1.9A
		480V	1.5A	1.5A	1.5A
		500V	1.4A	1.4A	1.4A
		600V	1.2A	1.2A	1.2A
Rated	1s	100A	100A	-	100A
Short-time withstand current	0.5s	125A	125A	-	120A
	0.1s	145A	145A	-	140A
Electrical lifetime (Mil. operations)	AC15 duty	220V	0.25	0.25	0.25
		440V	0.25	0.25	0.25
Maximum operating cycles per hour		1800	1800	1800	1800
Conductor size (Solid, stranded)	AWG	18~10	18~10	18~10	18~10
	(The max. number of conducts : 2) mm ²	1~2.5	1~2.5	1~2.5	1~2.5

Pneumatic timer



Air pressure timer

It is attached to the head-on of the magnetic contactor. It uses the principle of air pressure and it is delayed by the set time after the magnetic contactor is inserted and released and then the auxiliary contact of the Pneumatic timer is reversed

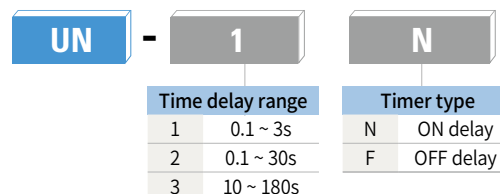

Note) Applicable MC: MC-6a ~ 100a, MC-9b ~ 22b, AC operation voltage



Combination with MC

Type	MC-6a~100a / MC-9b~22b					
	UN-1N	UN-2N	UN-3N	UN-1F	UN-2F	UN-3F
Standards	IEC60947-5-1, GB14048.5					
Certification	CCC, CE					
Degree of protection	IP20					
Temperature range	Storage	-25°C ~ +60°C				
	Operation	-5°C ~ +40°C				
Altitude	2,000m less					
Poles	1NO + 1NC					
Rated operating voltage	690V					
Rated insulation voltage	690V					
Frequency	50/60Hz					
Rated operation current (Ie)	A600(AC-15), Q600(DC-13)					
Ith(Thermal current)	10A					
Minimum switching current	10mA					
Irms rated making capacity	10 x Ie AC-15 acc. to IEC 60947-5-1					
Non overlap time	1.5ms					
Setting time	0.1~3s	0.1~30s	10~180s	0.1~3s	0.1~30s	10~180s
Operating time tolerance	±50% less					
Mechanical durability	2.5 mil. operations					

On Delay timer block(UN-N)

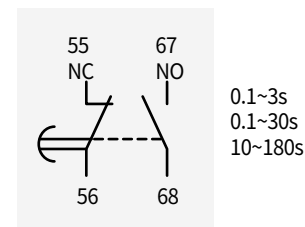

Off Delay timer block(UN-F)

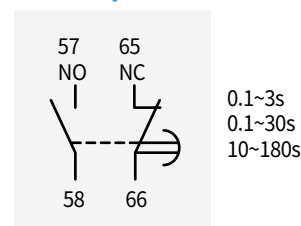

Mechanical latch unit ML, AL

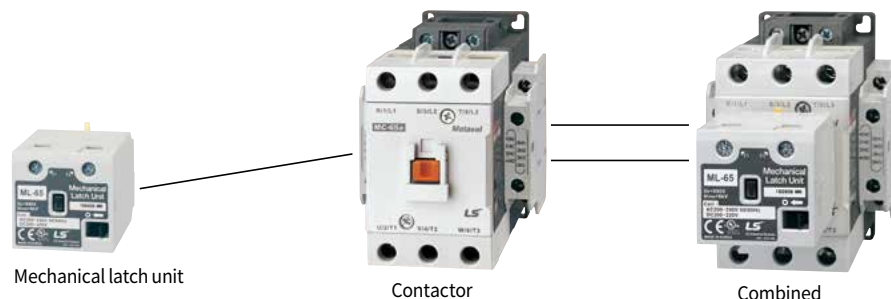

Rating

Applying contactors	Type	Coil voltage of latch unit	
MC-6a/L MC-9a/L MC-12a/L MC-18a/L MC-9b/L MC-12b/L MC-18b/L MC-22b/L MC-32a/L MC-40a/L MC-50a/L MC-65a/L	ML-65	Ordering voltage	Operation voltage
		AC 24V/ DC 24V	AC 24V 50/60Hz, DC 24V
		AC 48V/ DC 48V	AC 48V 50/60Hz, DC 48V
		AC 100V/DC 100V	AC 100~127V 50/60Hz, DC 100V~125V
		AC 200V/DC 200V	AC 200~240V 50/60Hz, DC 200V~220V
		AC 400V	AC 380V~440V 50/60Hz
MC-75a/L MC-85a/L MC-100a/L MC-130a/L MC-150a/L	ML-150	* Coils for 24, 48, 100, 200V are AC / DC common.	
MC-185a/L, 225a/L	AL-225	Ordering voltage	Operation voltage
		AC 100V	AC 100~127V 50/60Hz, DC 100~110V
MC-265a/L, 330a/L, 400a/L	AL-400	AC 200V	AC 200~240V 50/60Hz, DC 200~220V
		* For using safely the product providing DC control power, Please consider that the maximum switching frequency should be less than 150 times/hour.	

Note) Latch units for upto MC-150 are supplied separately. From MC-185 the units are assembled at factory.

To install

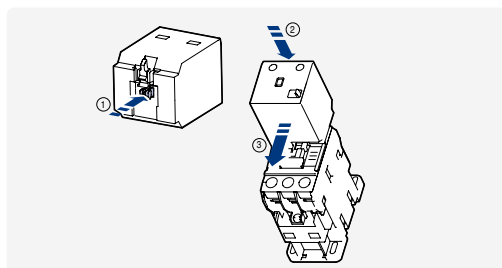

1. Push the black bar
2. Position the Latch on the top of the contactor
3. Pull in the direction of the arrow until snapping

To separate

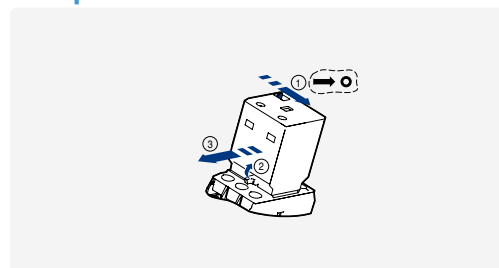

1. Pull the black lever in the direction of the arrow.
2. Pull up the yellow lever.
3. Push the latch in the direction of the arrow.

Delayed opening devices, AD

Delayed opening device prevents the inadvertent opening of a contactor in the event of a wide voltage drop or brief supply voltage interruptions of control power for 1 to 7 seconds.



Applying contactors	Type	Rated voltage	MC Rated voltage	Durability		Performance
				Mechanical	Electrical	
MC-6a~18a	AD-9	AC 110V	DC 110V	5 mil operations	1 mil operations	<ul style="list-style-type: none"> Making/Breaking capacity at AC3 <ul style="list-style-type: none"> - Making current : min. 10xIn - Breaking current : min. 8xIn Max. operating rate : 600 operations/hour Delaying time : 1~7sec. Capacitor durability <ul style="list-style-type: none"> 1) Operation :> 0.1 mil. operations 2) Cumulative charge life at AC 200/220V <ul style="list-style-type: none"> - 45°C or less: 80,000 hours - 50°C or less: 60,000 hours
MC-9b~22b		AC 220V	DC 220V			
MC-32a~40a	AD-32	AC 110V	DC 110V			
		AC 220V	DC 220V			
MC-50a~100a	AD-50	AC 110V	DC 110V			
		AC 220V	DC 220V			
MC-130a~225a	AD-100	AC 100~240V	AC/DC 100~240V	0.5 mil operations		
MC-265a~400a	AD-300	AC 100~240V	AC/DC 100~240V			
MC-500a~800a	AD-600	AC 100~127V	AC/DC 100~127V			
			AC 200~240V	AC/DC 200~240V		

*AD shall be used for DC type contactor

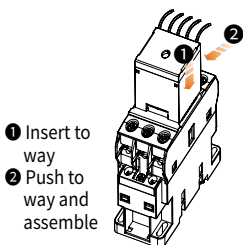

- 1 Insert to way
- 2 Push to way and assemble

Electronic timer unit, UT

Applying contactors	Type	Rated voltage	Performance	
MC-6a~150a MC-9b~22b MR-4~8	On delay	UT-1N	<ul style="list-style-type: none"> Mounting: Head on Contact: 1c Time delay: 1 Sec~30 Sec On delay, Off delay Frequency: AC 50/60Hz Operation: Min. voltage 85%, Max. voltage 110% Accuracy of setting time: ±20% 	
		UT-2N		AC/DC 24~48V
	Off delay	UT-1F		AC/DC 24~48V
		UT-2F		AC 110~220V

Terminal cover units for contactors, AP

Applying contactors	Type		Remarks
	Standard	Transparent	
MC-6a,9a,12a,18a (18AF)	AP-18	AP/T-6	2 pcs required per contactor
MC-9b,12b,18b,22b (22AF)	AP-22	AP/T-9	
MC-32a,40a (40AF)	AP-40	AP/T-32	
MC-50,65a (65AF)	AP-65	AP/T-50	
MC-75a,85a,100a (100AF)	AP-100	AP/T-75	
MC-130a,150a (150AF)	AP-150	AP/T-130	
MC-185a,225a (225AF)	AP-220	AP/T-185	
MC-265a,330a,400a (400AF)	AP-400	AP/T-265	
MC-500a,630a,800 (800AF)	AP-800	AP/T-500	

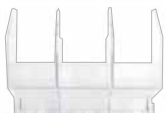

Insulation barrier units, AI

Applying contactors	Type	Remarks
MC-130a, 150a	AI-180	4 pcs required per contactor
MC-185a, 225a		
MC-265a, 330a, 400a		
MC-500a, 630a, 800a, 1260a	AI-800	
MC-1400a, 1700a, 2100a	AI-2100	
MC-2650a, MCI-1700, 2100, 2650	AI-2650	
MCI-900, 1050, 1260	AI-1260	

* The insulation barrier for MC-150a is available on the screw type only.

Interlocks

Component parts for assembling by customer

Interlock unit, UR-02 and AR-9 & Wire kit UW

UR-02 is a mechanical interlock unit and provides 2NC contacts for use in electrical interlocking

UW is used for making reversing circuit between two contactors.

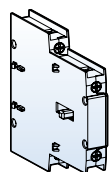

Interlock unit

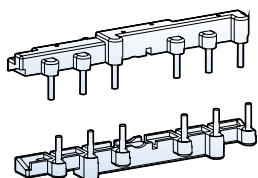

Wire kit

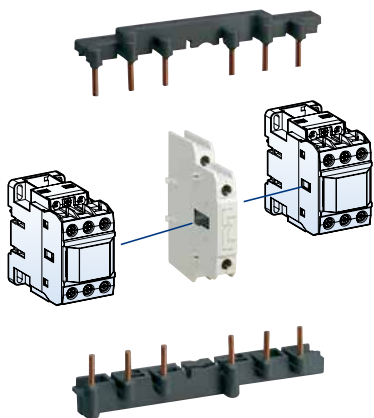

Contactor	Pole	Wire kit		Interlock unit		Aux Contact	
		Type	Weight	Type	Weight		
MC-6a~18a	3P	UW-18	0.05kg	UR-02	0.06kg	2NC	
	4P	-	-				
MC-9b~22b	3P	UW-22	0.04kg			-	-
MC-32a~40a		UW-32	0.05kg				
MC-50a, 65a		UW-63	0.12kg				
MC-75a~100a		UW-95	0.33kg				
MC-130a~150a		UW-150	0.6kg				
MC-22a~85a	4P	-	-	AR-9	0.05kg	-	

Rating of the contacts in the interlocks

Rated operation voltage		600V		
Rated insulation voltage		1000V		
Rated frequency		50/60Hz		
Rated thermal current		16A		
Rated operation current	AC15 duty (A600)	120V	6A	
		240V	3A	
		380V	1.9A	
		480V	1.5A	
		500V	1.4A	
		600V	1.2A	
		DC13 duty (Q300)	125V	0.55A
			250V	0.27A

MC-6aR ~ MC-150aR typical circuit diagram for reversing contactor

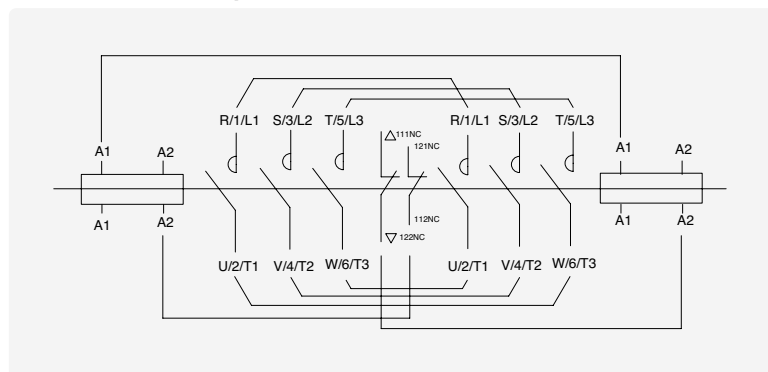

Interlock unit, AR-180 and AR-600

AR-180 and AR-600 are mechanical interlock units in which electrical contacts for use in electrical interlocking are not included. Please use the auxiliary contacts on the sides of the contactors for that purpose.

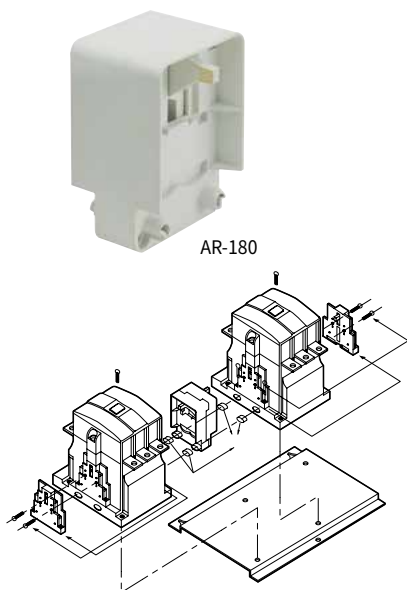

AR-180

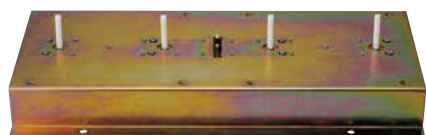

AR-600 & AR-600/V

Contactor	Pole	Interlock unit	
		Type	Weight
MC-100a	4P	AR-180	0.09kg
MC-130a			
MC-150a			
MC-185a			
MC-225a	3,4P	AR-180	0.09kg
MC-265a			
MC-330a			
MC-400a	3,4P	AR-600 AR-600/V	15.2kg
MC-500a			
MC-630a			
MC-800a			

* AR-600 3pole product is different fro, AR-600 4pole product in size.
 * The AR-600 / Vis a vertical interlock unit.

MC-180aR ~ MC-800aR typical circuit diagram for reversing contactor

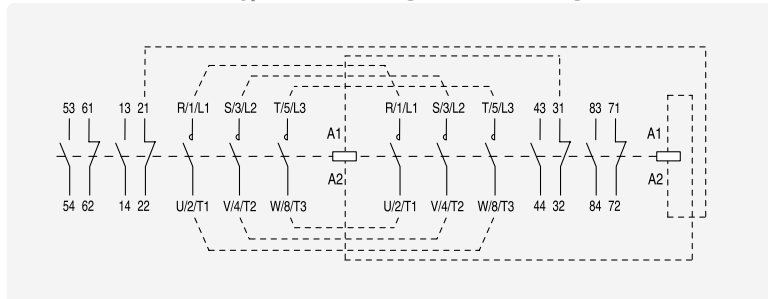

Installation of interlock and wire kits

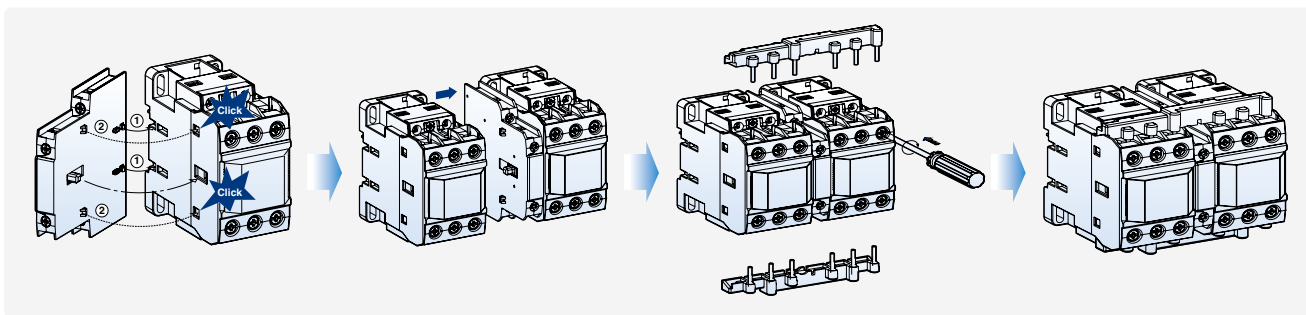

Install the interlock unit on the side of a contactor first. fit each part as indicated in the fig.

And then install the other contactor on the other side of the interlock unit as shown.

After installing interlock unit wiring kit can be assembled. Wiring kit contains two molded wires - one for line side and the other for load side.

- In case of assembling Reversing contactor, please check the R, S, T/U, V, W mark on the contactor and Wire kit.

Surge unit

- It absorbs the surge arisen out of the coil of the contactor.
- It can be installed simply to the contactor.
 - Rated operation voltage (Ue): AC 24 ~ 440V / DC 24 ~ 125V
 - Rated insulation voltage (Ui): 1000V
 - Rated impulse withstand voltage (Uimp): 8kV
 - Degree of protection: IP20
 - Combination with 3Pole 6a/3~150a/3, 4Pole 32a/4~85a/4

US Type



Surge unit		Rated voltage		Internal elements spec.			Contactor
Type	Composition			V	R	C	
US-1	Varistor+RC	AC	24~48V	120V	100Ω	0.1μF	3Pole MC 6a~150a 9b~22b 4Pole MC 6a/4~18a/4
US-2	Varistor+RC		100~125V	270V	100Ω	0.1μF	
US-3	Varistor+RC		200~240V	470V	100Ω	0.1μF	
US-4	Varistor+RC	DC	24~48V	120V	100Ω	0.47μF	
US-5	Varistor+RC		100~125V	270V	100Ω	0.47μF	
US-6	Varistor+RC		200~220V	470V	100Ω	0.47μF	
US-11	Varistor	AC/DC Common	24~48V	120V	-	-	
US-12	Varistor		100~125V	270V	-	-	
US-13	Varistor		200~240V	470V	-	-	
US-14	Varistor		380~440V	1000V	-	-	
US-22	RC	AC	100~125V	-	56Ω	1μF	

Installation (US Type)

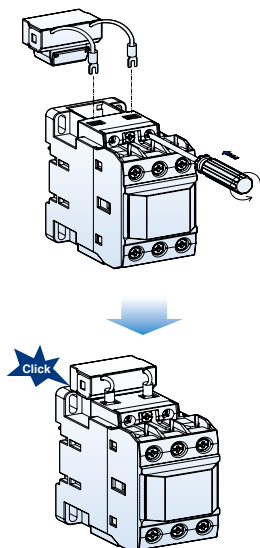

Connect the lead wires to the coil terminals of the contactor first. And then insert the body into the space of the contactor as shown above.

AS Type

Surge unit		Rated voltage		Internal elements spec.			Contactor
Type	Composition			V	R	C	
AS-1	Varistor+RC	AC	24~48V	120V	100Ω	0.1μF	3Pole MC 185a~800a 4Pole MC 22a/4~800a/4
AS-2	Varistor+RC		100~125V	270V	100Ω	0.1μF	
AS-3	Varistor+RC		200~240V	470V	100Ω	0.1μF	
AS-4	Varistor+RC	DC	24~48V	120V	100Ω	0.47μF	
AS-5	Varistor+RC		100~125V	270V	100Ω	0.47μF	
AS-6	Varistor+RC		200~220V	470V	100Ω	0.47μF	
AS-11	Varistor	AC/DC Common	24~48V	120V	-	-	
AS-12	Varistor		100~125V	270V	-	-	
AS-13	Varistor		200~240V	470V	-	-	
AS-14	Varistor		AC	380~440V	1000V	-	-

Specification of surge unit

Without surge unit	① With varistor unit	② With CR+Varistor unit
Surge voltage, arise when the coil is off, may provoke mis-operation and damage in the circuit.	Varistor has an effect to cut down the peak voltage	Varistor has an effect to cut down the peak voltage and high frequency wave

Capacitor unit

Capacitor unit is connected to the terminals of the contactor to reduce the high inrush current.
IEC 60947-5-1



Type (AUX Contact 1b)		AC-9 (1b)	AC-50 (1b)	AC-75 (1b)	
Rating thermal current (Ith)		16A	16A	16A	
Current	AC-15	Rated Operational Current (A)	120V	6	6
			240V	3	3
			380V	1.9	1.9
			480V	1.5	1.5
			500V	1.4	1.4
	DC-13	Rated Operational Current (A)	600V	1.2	1.2
			125V	0.55	0.55
			250V	0.27	0.27
			400V	0.15	0.15
			500V	0.13	0.13
		600V	0.1	0.1	

Features of capacitor unit (Pre-loading resistor)

- Damping resistor that can limit the inrush current upto $60 \times I_n$ is connected to the mechanism that closed earlier than the main contact of the contactor
- No heat loss by the serial resistor
- Eliminate the switching surge
- Improving the performance of the capacitor system

Operation sequence

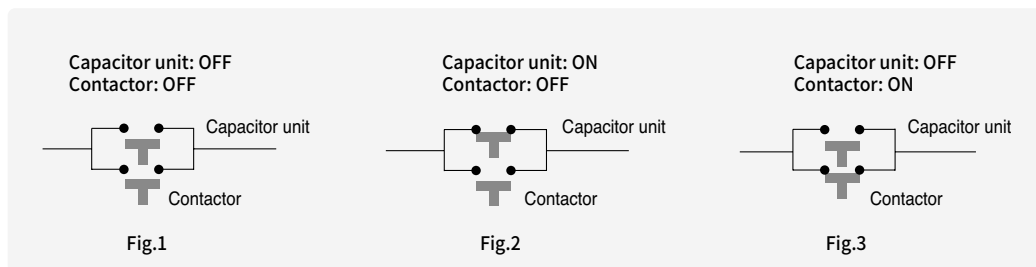

Note) Closing sequence: Fig.1 => Fig.2 => Fig.3
Opening sequence: Fig.3 => Fig.1

Replacement coils

To replace the existing coil to change voltage or repair.



Contactor	Coil voltage							
	AC coil						DC coil	
	AC 60Hz (V)		AC 50Hz (V)		AC 50/60Hz (V)		DC (V)	
MC-6a MC-9a MC-12a MC-18a MR-4, 6, 8	24	230	24	230	24	240		
	48	240	36	240	48	380		
	100	277	42	380	100	415		
	110	380	48	400	110	440		
	120	440	80	415	120	500		
	200	480	100	440	200	550		
	208	600	110	500	220			
		220	550	230				
MC-9b MC-12b MC-18b MC-22b	24	230	24	230	24	240		
	48	240	36	240	48	380		
	100	277	42	380	100	415		
	110	380	48	400	110	440		
	120	440	80	415	120	500		
	200	480	100	440	200	550		
	208	600	110	500	220			
		220	550	230				
MC-32a MC-40a	24	230	24	230	24	240	12	110
	48	240	36	240	48	380	20	125
	100	277	42	380	100	415	24	200
	110	380	48	400	110	440	48	220
	120	440	80	415	120	500	60	250
	200	480	100	440	200	550	80	
	208	600	110	500	220		100	
		220	550	230				
MC-50a MC-65a	24	230	24	230	24	240	12	110
	48	240	36	240	48	380	20	125
	100	277	42	380	100	415	24	200
	110	380	48	400	110	440	48	220
	120	440	80	415	120	500	60	250
	200	480	100	440	200	550	80	
	208	600	110	500	220		100	
		220	550	230				
MC-75a MC-85a MC-100a	24	230	24	230	24	240	12	110
	48	240	36	240	48	380	20	125
	100	277	42	380	100	415	24	200
	110	380	48	400	110	440	48	220
	120	440	80	415	120	500	60	250
	200	480	100	440	200	550	80	
	208	600	110	500	220		100	
		220	550	230				
MC-130a MC-150a					24	220~240	24	110
					48	300	48	220
					24~48	380~440	24~48	
					100~240	500	70~110	
					110~120		100~220	

Replacement process

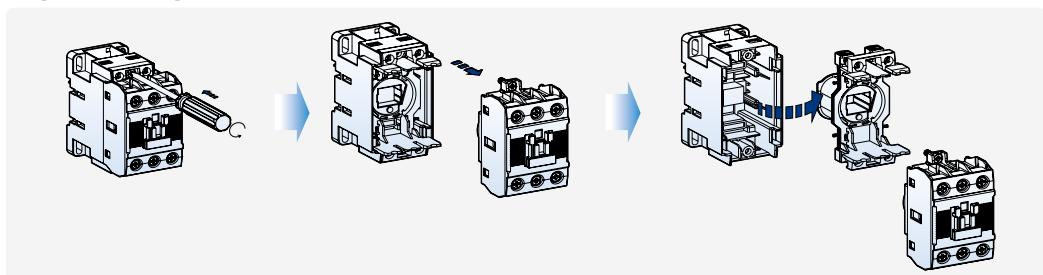



To replace the existing coil to change voltage or repair.

Contactor	Coil voltage	
	AC/DC common coil (V)	AC coil (V)
MC-185a MC-225a	24 48 100~240/100~220	300 400 500
MC-265a MC-300a MC-400a	DC 24 100~240/100~220	300 400 500
MC-500a MC-630a MC-800a MCI-900 MCI-1050	100/100 200/200	300 400 500
MC-1260 MCI-1260	100~240/100~220	-
MC-1400a MC-1700a MC-2100a MC-2650a MCI-1700 MCI-2100 MCI-2650	100~240/100~220	-

Safety cover (Option)

To prevent arc from coming out from the contactor To protect from unintended manual operation To prevent dust from entering into the inside of the contactor

Type	Contactor
AP-9	MC-6a~150a
AP-185	MC-185a~800a

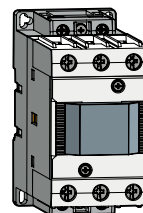

Overload relays

General descriptions

Type MT, bimetal-style, overload relays are designed to protect AC circuits and motors against overloads, phase failure, long starting times and prolonged stalling of the motor.

Four versions are available according to the protection function and trip class as below.

1. Non-differential: 3pole-2bimetal(Heater) and trip class 10A
2. Non-differential: 3pole-3bimetal(Heater) and trip class 10A
3. Differential: 3pole-3bimetal(Heater) and trip class 10A
4. Differential: 3pole-3bimetal(Heater) and trip class 20

Configuration of the front

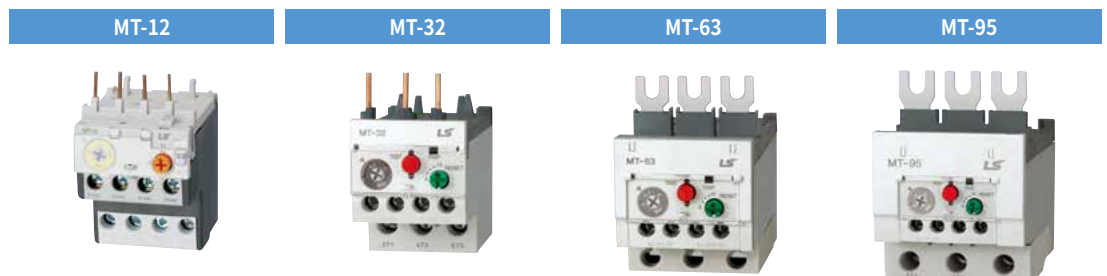
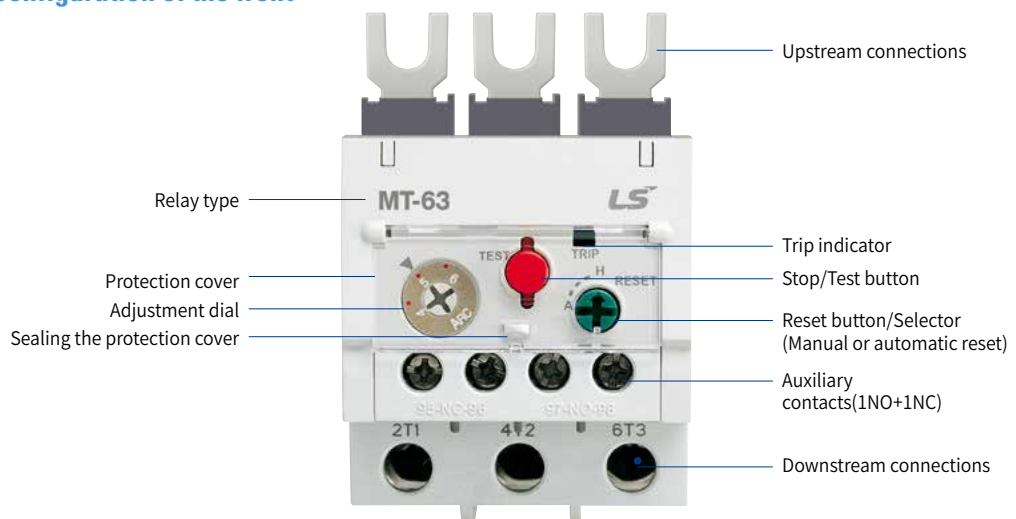

Environment and auxiliary circuit

Environment		MT-12~800	
Standards		IEC/EN 60947-1, IEC/EN 60947-4-1	
Certifications		CE, CSA, UL, CCC	
Rated operation voltage		Max. 690V	
Rated insulation voltage		690V	
Rated frequency		50/60Hz	
Degree of protection (Conforming to IEC 60 529)		IP 20	
Ambient air temperature	Storage	-30 ~ +65°C	
	Operation	-25 ~ +60°C (MT refer to Graph)	
Mounting position		Vertical plane	
Shock resistance (Conforming to IEC 68-2-7)		15gn - 11ms	
Vibration resistance (Conforming to IEC68-2-6)		6G	
Insulation strength (Conforming to IEC 255-5)		6kV	
Rated impulse withstand voltage (Conforming to IEC 801-5)		6kV	
Auxiliary contacts characteristics			
Composition		1NO +1NC	
Rated thermal current		5A	
Rated operation current		C600, R300	
AC15 duty (C600)	120V	1.5A	
	240V	0.75A	
	380V	0.47A	
	480V	0.375A	
	500V	0.35A	
	600V	0.3A	
	DC13 duty (R300)	120V	0.22A
		240V	0.1A
	Connecting conductor	Size	18AWG /1mm ²
	Connection to screw clamp terminals	Type	65/75°C Cu-wire

MT-150



MT-225



MT-400



MT-800



Overload relay specifications

MT type Thermal overload relays

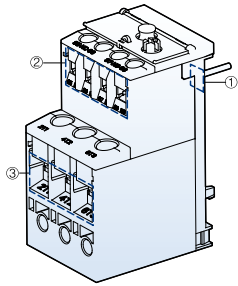

- ① Main terminals/upstream
- ② Auxiliary terminals
- ③ Main terminals/downstream

Frame size		18AF		
Trip class		10A	20	
Type	Non-differential (3P-2 heater)	MT-12/2H□S	-	
	Non-differential (3P-3 heater)	MT-12/3H□S	-	
	Differential type	MT-12/3K□S	MT-12/3D□S	
Terminals	Main-upstream	Screw clamp		
	Main-downstream	Screw clamp		
	Auxiliary	Screw clamp		
Number of poles		3		
Rated operational voltage (Ue)		690V		
Rated insulation voltage (Ui)		Up to 690V		
Rated impulse voltage (Uimp)		6kV		
Degree of protection (IEC 60 529)		IP 20		
Temperature compensation (°C)		-5~+40°C		
Functions	Trip indicating	■		
	Stop	-		
	Test	■		
	Manual/Automatic reset	■		
Setting range(A)		0.1~18A	1~18A	
Nominal current rating	Wire size			
	mm ²	AWG		
0.14	1	18	0.1~0.16	
0.21			0.16~0.25	
0.33			0.25~0.4	
0.52			0.4~0.63	
0.82			0.63~1	
1.3			1~1.6	1~1.6
2.1			1.6~2.5	1.6~2.5
3.3			2.5~4	2.5~4
5			4~6	4~6
6.5			5~8	5~8
7.5	1~1.5	18~16	6~9	
8.5			7~10	7~10
11	1.5~2.5	16~14	9~13	
15	2.5	14~12	12~18	
19	2.5~4	12~10		
21.5				
27	4~6	10		
30	4~10	10~8		
34	6~10	10~8		
42	10	8		
54				
65	16~25	6~4		
74				
83	25~35	4~3		
90				
Applied contactors		MC-6a, 9a, 12a, 18a		
Separate mounting unit		UZ-12		

Note: Screw clamp and Lug types are available for the main terminals of 65AF, 100AF and 150AF relays.
The other AF relays provide Screw clamp types only.



40AF		65AF		100AF	
10A	20	10A	20	10A	20
MT-32/2H□S	-	MT-63/2H□S/L	-	MT-95/2H□S/L	-
MT-32/3H□S	-	MT-63/3H□S/L	-	MT-95/3H□S/L	-
MT-32/3K□S	MT-32/3D□S	MT-63/3K□S/L	MT-63/3D□S/L	MT-95/3K□S/L	MT-95/3D□S/L
Screw clamp		Screw/Lug clamp		Screw/Lug clamp	
Screw clamp		Screw/Lug clamp		Screw/Lug clamp	
Screw clamp		Screw clamp		Screw clamp	
3		3		3	
690V		690V		690V	
Up to 690V		Up to 690V		Up to 690V	
6kV		6kV		6kV	
IP 20		IP 20		IP 20	
-5~+40°C		-5~+40°C		-5~+40°C	
■		■		■	
■		■		■	
■		■		■	
■		■		■	
0.1~40A	1~40A	4~65A		7~100A	
0.1~0.16					
0.16~0.25					
0.25~0.4					
0.4~0.63					
0.63~1					
1~1.6	1~1.6				
1.6~2.5	1.6~2.5				
2.5~4	2.5~4				
4~6	4~6	4~6	4~6		
5~8	5~8	5~8	5~8		
6~9	6~9	6~9	6~9		
7~10	7~10	7~10	7~10	7~10	7~10
9~13	9~13	9~13	9~13	9~13	9~13
12~18	12~18	12~18	12~18	12~18	12~18
16~22	16~22	16~22	16~22	16~22	16~22
18~25	18~25	18~25	18~25	18~25	18~25
22~32	22~32	-	-	-	-
-	-	24~36	24~36	24~36	24~36
28~40	28~40	28~40	28~40	28~40	28~40
		34~50	34~50	34~50	34~50
		45~65	45~65	45~65	45~65
				54~75	54~75
				63~85	63~85
				70~95	70~95
				80~100	80~100
MC-9b, 12b, 18b, 22b, 32a, 40a		MC-50a, 65a		MC-75a, 85a, 100a	
UZ-32		UZ-63S/L		UZ-95S/L	

Overload relay specifications

MT type Thermal overload relays

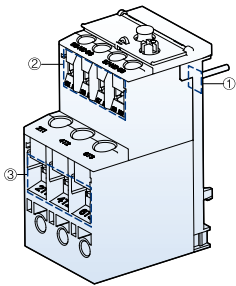

- ① Main terminals/upstream
- ② Auxiliary terminals
- ③ Main terminals/downstream

Frame size			150AF	
Trip class			10A	20
Type	Non-differential (3P-2 heater)		MT-150/2HCIS/L	-
	Non-differential (3P-3 heater)		MT-150/3HCIS/L	-
	Differential type		MT-150/3KCIS/L	MT-150/3DCIS/L
Terminals	Main-upstream		Screw/Lug clamp	
	Main-downstream		Screw/Lug clamp	
	Auxiliary		Screw clamp	
Number of poles			3	
Rated operational voltage (Ue)			690V	
Rated insulation voltage (Ui)			690V	
Rated impulse voltage (Uimp)			6kV	
Degree of protection (IEC 60 529)			IP 20	
Temperature compensation (°C)			-5~+40°C	
Functions	Trip indicating		■	
	Stop		■	
	Test		■	
	Manual/Automatic reset		■	
Setting range(A)			34~150A	34~150A
Nominal current rating	Wire size			
	mm ²	AWG		
42	10	8	34~50	
55	16	6	45~65	
65	25	4	54~75	
74	25	4	63~85	
80	35	3	-	
93	35	2	80~105	
107	50	1	-	
113	50	1	95~130	
130	50	0	110~150	
130	70	00		
153	95	000		
200	120	250		
265	185	350		
350	240	500		
515	185×2n	350×2n		
660	240×2n	300×3n		
Applied contactors			MC-130a, 150a	
Separate mounting unit			UZ-150S/L	

Note: Screw clamp and Lug types are available for the main terminals of 65AF, 100AF and 150AF relays.
The other AF relays provide Screw clamp types only.



225AF		400AF		800AF	
10A	20	10A	20	10A	20
MT-225/2H□S	-	MT-400/2H□S	-	MT-800/2H□S/L	-
MT-225/3H□S	-	MT-400/3H□S	-	MT-800/3H□S/L	-
MT-225/3K□S	MT-225/3D□S	MT-400/3K□S	MT-400/3D□S	MT-800/3K□S/L	MT-800/3D□S/L
Screw clamp		Screw clamp		Screw clamp	
Screw clamp		Screw clamp		Screw clamp	
Screw clamp		Screw clamp		Screw clamp	
3		3		3	
690V		690V		690V	
690V		690V		690V	
6kV		6kV		6kV	
IP 20		IP 20		IP 20	
-5~+40°C		-5~+40°C		-5~+40°C	
■		■		■	
■		■		■	
■		■		■	
■		■		■	
65~240A	65~240A	85~400A	85~400A	200~800A	200~800A
65~100					
-					
85~125		85~125			
-		-			
-		-			
100~160		100~160			
120~185		120~185			
160~240		160~240			
		200~330		200~300	
		260~400		260~400	
				400~600	
				520~800	
MC-185a, 225a		MC-265a, 330a, 400a		MC-500a, 630a, 800a	
-		-		-	

Overload relay operation

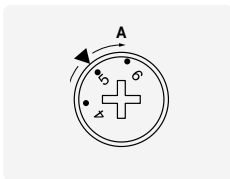
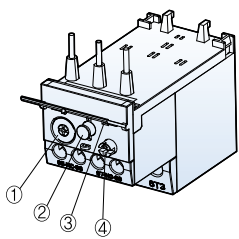
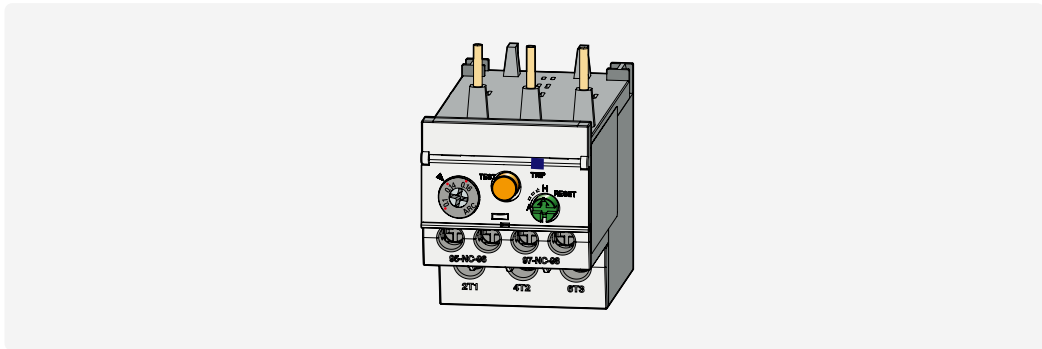

1. Adjustment dial

- Before adjusting the dial open the protection cover.
- Current setting can be done easily by using (+) or (-) driver and have to be set by dotting or graduations standard.
- Do not rotate the dial out of the setting range.

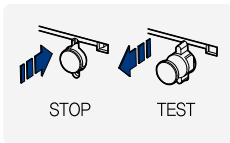

2. Stop/Test button

- STOP function is executed by pushing the button, which causes the next sequence.
- In case of operation test pull this button.

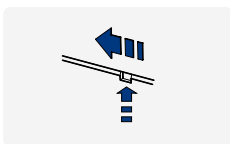

3. Trip indicator

- If relay is tripped it comes out.

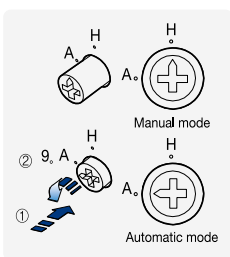

4. Reset button/Selector

- Using a driver the reset mode can be set.
- In case of Manual mode(H) push the button to reset the relay.
- To change to Automatic mode(A) from Manual mode push the button and rotate as shown in the fig.

5. Auxiliary contact operation

Terminal no.	Normal	Stop	Test/Trip	Reset
NC 95-96				
NO 97-98				

Separate mounting units

These accessories are used to mount the relays separately from contactors.
If a relay is combined with a unit, it can be mounted on DIN rail or panel by fixing screws.



Relay	Unit	
	Type	Weight
MT-12/2H□ MT-12/3H□ MT-12/3K□ MT-12/3D□	UZ-12	35g
MT-32/2H□ MT-32/3H□ MT-32/3K□ MT-32/3D□	UZ-32	68g
MT-63/2H□ MT-63/3H□ MT-63/3K□ MT-63/3D□	UZ-63S/L	134g
MT-95/2H□ MT-95/3H□ MT-95/3K□ MT-95/3D□	UZ-95S/L	230g
MT-150/2H□ MT-150/3H□ MT-150/3K□ MT-150/3D□	UZ-150S/L	284g

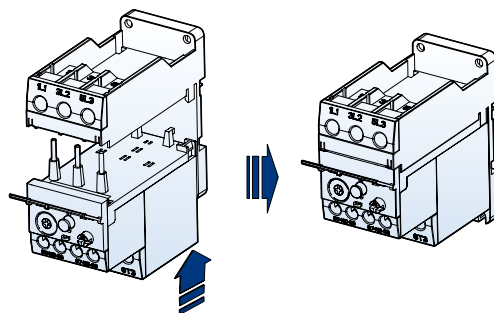

Terminal cover units for overload relays



Relay	Remarks
MT-225	2 pcs
MT-400	

Accessories for overload relay

Remote reset units



These accessories are used to reset the relays on the panel door.

Type	Cable length (L)
UM-4R	400 mm
UM-5R	500 mm
UM-6R	600 mm
UM-7R	700 mm
UM-9R	900 mm

1. Make the reset bar straight at least 55mm from the panel door and 35mm from the bracket.
2. The bending radius of the flexible reset bar should not be less than 15mm.

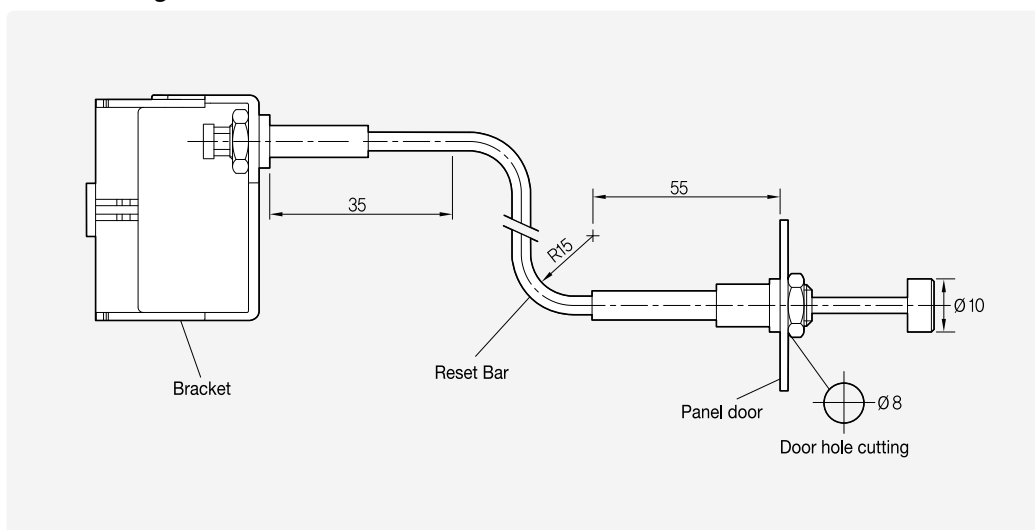

Installation

1. Fit the bracket with the relay as indicated(*1) below.
2. Separate Nut(*3) and Head cap(*4) from the reset bar first.
Insert the reset bar into the panel hole and then fix it with the Nut and Head.
3. To separate the bracket from the relay lift the *2 part as shown in the fig.

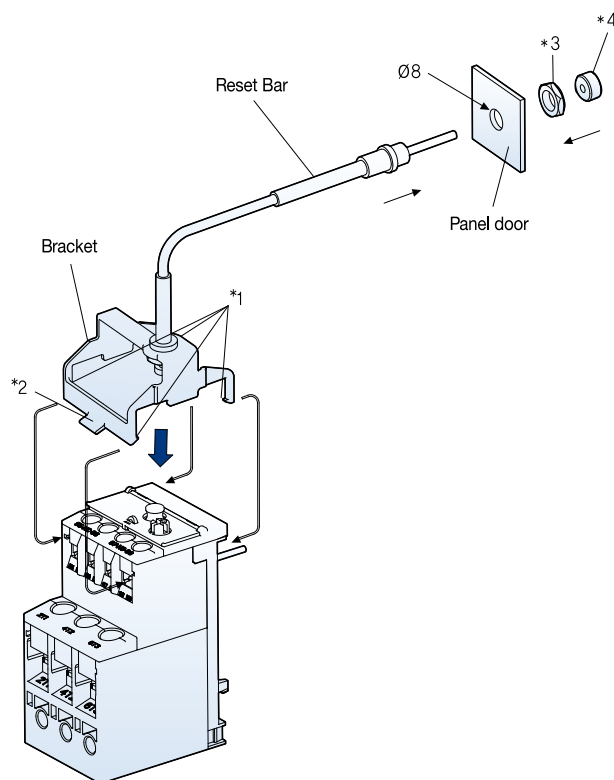
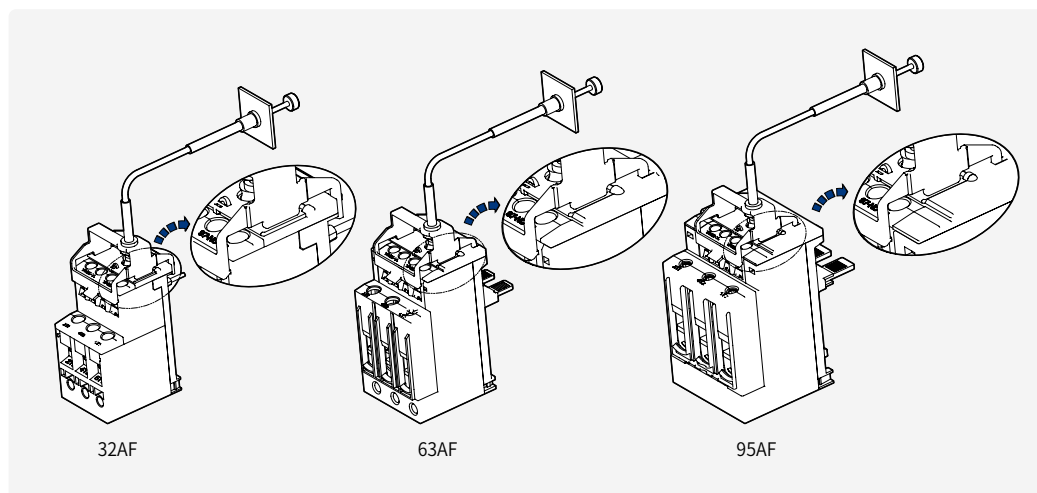

Accessories for overload relay

Remote reset units

MT-32

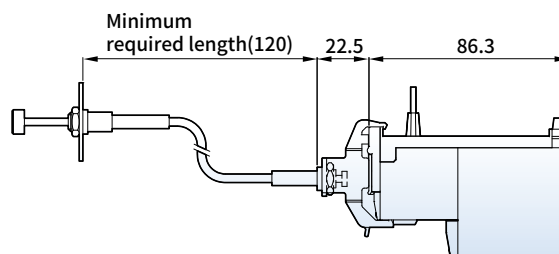

MT-63

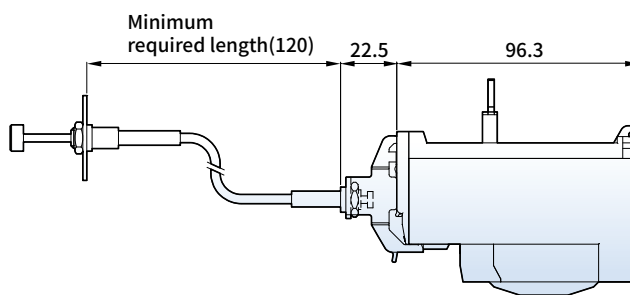

MT-95

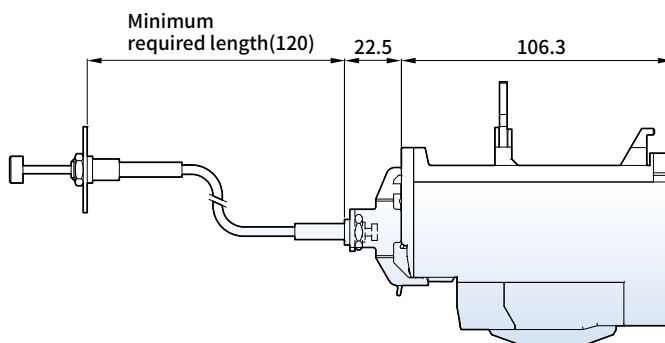

MT-150

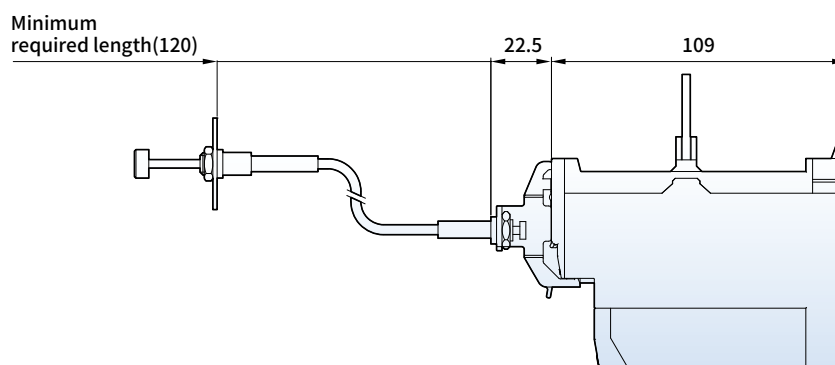

MT-225

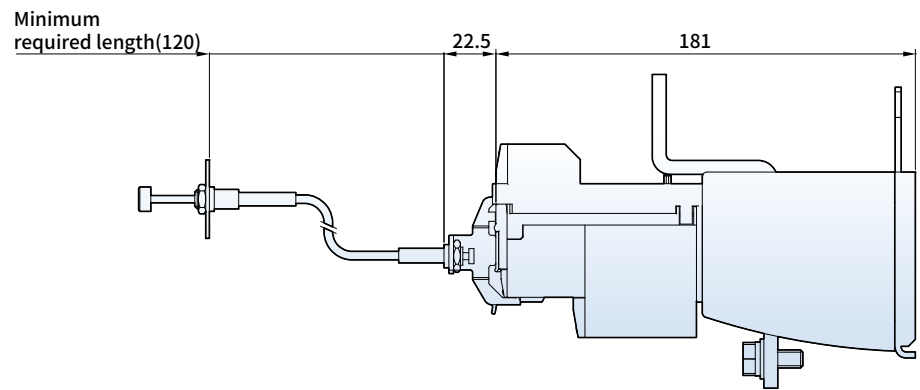

MT-400

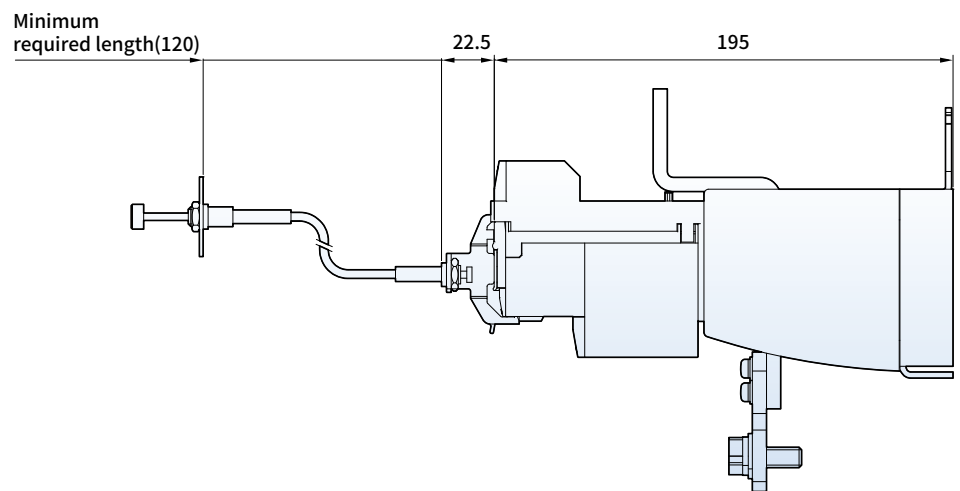

MT-800

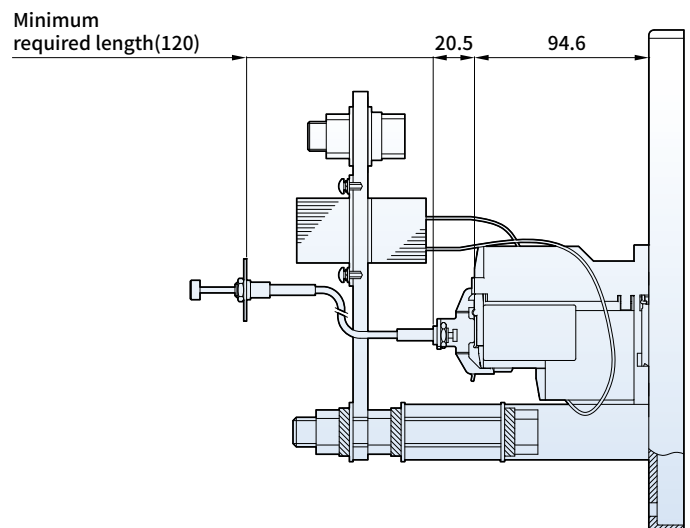

Overload relay ordering types

Trip class 10A



MT-12/□

MT-12 (Terminal type: Screw / Degree of protection: IP20)

Setting range (A)	Ordering type			Contactor	Separate mounting unit
	Non-differential (3P-2 heater)	Non-differential (3P-3 heater)	Differential		
0.1~0.16	MT-12/2H0.14	MT-12/3H0.14	MT-12/3K0.14	MC-6a MC-9a MC-12a MC-18a	UZ-12
0.16~0.25	MT-12/2H0.21	MT-12/3H0.21	MT-12/3K0.21		
0.25~0.4	MT-12/2H0.33	MT-12/3H0.33	MT-12/3K0.33		
0.4~0.63	MT-12/2H0.52	MT-12/3H0.52	MT-12/3K0.52		
0.63~1	MT-12/2H0.82	MT-12/3H0.82	MT-12/3K0.82		
1~1.6	MT-12/2H1.3	MT-12/3H1.3	MT-12/3K1.3		
1.6~2.5	MT-12/2H2.1	MT-12/3H2.1	MT-12/3K2.1		
2.5~4	MT-12/2H3.3	MT-12/3H3.3	MT-12/3K3.3		
4~6	MT-12/2H5	MT-12/3H5	MT-12/3K5		
5~8	MT-12/2H6.5	MT-12/3H6.5	MT-12/3K6.5		
6~9	MT-12/2H7.5	MT-12/3H7.5	MT-12/3K7.5		
7~10	MT-12/2H8.5	MT-12/3H8.5	MT-12/3K8.5		
9~13	MT-12/2H11	MT-12/3H11	MT-12/3K11		
12~18	MT-12/2H15	MT-12/3H15	MT-12/3K15		



MT-32/□

MT-32 (Terminal type: Screw / Degree of protection: IP20)

Setting range (A)	Ordering type			Contactor	Separate mounting unit
	Non-differential (3P-2 heater)	Non-differential (3P-3 heater)	Differential		
0.1~0.16	MT-32/2H0.14	MT-32/3H0.14	MT-32/3K0.14	MC-9b MC-12b MC-18b MC-22b MC-32a MC-40a	UZ-32
0.16~0.25	MT-32/2H0.21	MT-32/3H0.21	MT-32/3K0.21		
0.25~0.4	MT-32/2H0.33	MT-32/3H0.33	MT-32/3K0.33		
0.4~0.63	MT-32/2H0.52	MT-32/3H0.52	MT-32/3K0.52		
0.63~1	MT-32/2H0.82	MT-32/3H0.82	MT-32/3K0.82		
1~1.6	MT-32/2H1.3	MT-32/3H1.3	MT-32/3K1.3		
1.6~2.5	MT-32/2H2.1	MT-32/3H2.1	MT-32/3K2.1		
2.5~4	MT-32/2H3.3	MT-32/3H3.3	MT-32/3K3.3		
4~6	MT-32/2H5	MT-32/3H5	MT-32/3K5		
5~8	MT-32/2H6.5	MT-32/3H6.5	MT-32/3K6.5		
6~9	MT-32/2H7.5	MT-32/3H7.5	MT-32/3K7.5		
7~10	MT-32/2H8.5	MT-32/3H8.5	MT-32/3K8.5		
9~13	MT-32/2H11	MT-32/3H11	MT-32/3K11		
12~18	MT-32/2H15	MT-32/3H15	MT-32/3K15		
16~22	MT-32/2H19	MT-32/3H19	MT-32/3K19		
18~25	MT-32/2H21.5	MT-32/3H21.5	MT-32/3K21.5		
22~32	MT-32/2H27	MT-32/3H27	MT-32/3K27		
28~40	MT-32/2H34	MT-32/3H34	MT-32/3K34		UZ-32(34A)

MT-63 (Terminal type: Screw(S), Lug(L) / Degree of protection: IP20)



MT-63/S



MT-63/L

Setting range (A)	Ordering type			Contactor	Separate mounting unit
	Non-differential (3P-2 heater)	Non-differential (3P-3 heater)	Differential		
4-6	MT-63/2H5S/L	MT-63/3H5S/L	MT-63/3K5S/L	MC-50a MC-65a	UZ-63S/L
5-8	MT-63/2H6.5S/L	MT-63/3H6.5S/L	MT-63/3K6.5S/L		
6-9	MT-63/2H7.5S/L	MT-63/3H7.5S/L	MT-63/3K7.5S/L		
7-10	MT-63/2H8.5S/L	MT-63/3H8.5S/L	MT-63/3K8.5S/L		
9-13	MT-63/2H11S/L	MT-63/3H11S/L	MT-63/3K11S/L		
12-18	MT-63/2H15S/L	MT-63/3H15S/L	MT-63/3K15S/L		
16-22	MT-63/2H19S/L	MT-63/3H19S/L	MT-63/3K19S/L		
18-25	MT-63/2H21.5S/L	MT-63/3H21.5S/L	MT-63/3K21.5S/L		
24-36	MT-63/2H30S/L	MT-63/3H30S/L	MT-63/3K30S/L		
28-40	MT-63/2H34S/L	MT-63/3H34S/L	MT-63/3K34S/L		
34-50	MT-63/2H42S/L	MT-63/3H42S/L	MT-63/3K42S/L		
45-65	MT-63/2H55S/L	MT-63/3H55S/L	MT-63/3K55S/L		

MT-95 (Terminal type: Screw(S), Lug(L) / Degree of protection: IP20)



MT-95/S



MT-95/L

Setting range (A)	Ordering type			Contactor	Separate mounting unit
	Non-differential (3P-2 heater)	Non-differential (3P-3 heater)	Differential		
7-10	MT-95/2H8.5S/L	MT-95/3H8.5S/L	MT-95/3K8.5S/L	MC-75a MC-85a MC-100a	UZ-95S/L
9-13	MT-95/2H11S/L	MT-95/3H11S/L	MT-95/3K11S/L		
12-18	MT-95/2H15S/L	MT-95/3H15S/L	MT-95/3K15S/L		
16-22	MT-95/2H19S/L	MT-95/3H19S/L	MT-95/3K19S/L		
18-25	MT-95/2H21.5S/L	MT-95/3H21.5S/L	MT-95/3K21.5S/L		
24-36	MT-95/2H30S/L	MT-95/3H30S/L	MT-95/3K30S/L		
28-40	MT-95/2H34S/L	MT-95/3H34S/L	MT-95/3K34S/L		
34-50	MT-95/2H42S/L	MT-95/3H42S/L	MT-95/3K42S/L		
45-65	MT-95/2H55S/L	MT-95/3H55S/L	MT-95/3K55S/L		
54-75	MT-95/2H65S/L	MT-95/3H65S/L	MT-95/3K65S/L		
63-85	MT-95/2H74S/L	MT-95/3H74S/L	MT-95/3K74S/L		
70-95	MT-95/2H83S/L	MT-95/3H83S/L	MT-95/3K83S/L		
80-100	MT-95/2H90S/L	MT-95/3H90S/L	MT-95/3K90S/L		

MT-150 (Terminal type: Screw(S), Lug(L) / Degree of protection: IP20)



MT-150

Setting range (A)	Ordering type			Contactor	Separate mounting unit
	Non-differential (3P-2 heater)	Non-differential (3P-3 heater)	Differential		
34-50	MT-150/2H42S/L	MT-150/3H42S/L	MT-150/3K42S/L	MC-130a MC-150a	UZ-150S/L
45-65	MT-150/2H55S/L	MT-150/3H55S/L	MT-150/3K55S/L		
54-75	MT-150/2H65S/L	MT-150/3H65S/L	MT-150/3K65S/L		
63-85	MT-150/2H74S/L	MT-150/3H74S/L	MT-150/3K74S/L		
80-105	MT-150/2H93S/L	MT-150/3H93S/L	MT-150/3K93S/L		
95-130	MT-150/2H113S/L	MT-150/3H113S/L	MT-150/3K113S/L		
110-150	MT-150/2H130S/L	MT-150/3H130S/L	MT-150/3K130S/L		

Overload relay ordering types

Trip class 10A



MT-225/□

MT-225 (Terminal type: Screw / Degree of protection: IP20)

Setting range (A)	Ordering type			Contactor	Remarks
	Non-differential (3P-2 heater)	Non-differential (3P-3 heater)	Differential		
65~100	MT-225/2H80	MT-225/3H80	MT-225/3K80	MC-185a MC-225a	-
85~125	MT-225/2H107	MT-225/3H107	MT-225/3K107		
100~160	MT-225/2H130	MT-225/3H130	MT-225/3K130		
120~185	MT-225/2H153	MT-225/3H153	MT-225/3K153		
160~240	MT-225/2H200	MT-225/3H200	MT-225/3K200		



MT-400/□

MT-400 (Terminal type: Screw / Degree of protection: IP20)

Setting range (A)	Ordering type			Contactor	Remarks
	Non-differential (3P-2 heater)	Non-differential (3P-3 heater)	Differential		
85~125	MT-400/2H107	MT-400/3H107	MT-400/3K107	MC-265a MC-330a MC-400a	-
100~160	MT-400/2H130	MT-400/3H130	MT-400/3K130		
120~185	MT-400/2H153	MT-400/3H153	MT-400/3K153		
160~240	MT-400/2H200	MT-400/3H200	MT-400/3K200		
200~330	MT-400/2H265	MT-400/3H265	MT-400/3K265		
260~400	MT-400/2H350	MT-400/3H350	MT-400/3K350		



MT-800/□

MT-800 (Terminal type: Screw / Degree of protection: IP20)

Setting range (A)	Ordering type			Contactor	Remarks
	Non-differential (3P-2 heater)	Non-differential (3P-3 heater)	Differential		
200~330	MT-800/2H265	MT-800/3H265	MT-800/3K265	MC-500a MC-630a MC-800a	-
260~400	MT-800/2H350	MT-800/3H350	MT-800/3K350		
400~630	MT-800/2H515	MT-800/3H515	MT-800/3K515		
520~800	MT-800/2H660	MT-800/3H660	MT-800/3K660		

Trip class 20A



MT-12/3D□

MT-12 (Terminal type: Screw / Degree of protection: IP20)

Setting range (A)	Ordering type	Contactor	Separate mounting unit
	Differential		
1~1.6	MT-12/3D1.3	MC-6a MC-9a MC-12a MC-18a	UZ-12
1.6~2.5	MT-12/3D2.1		
2.5~4	MT-12/3D3.3		
4~6	MT-12/3D5		
5~8	MT-12/3D6.5		
6~9	MT-12/3D7.5		
7~10	MT-12/3D8.5		
9~13	MT-12/3D11		
12~18	MT-12/3D15		



MT-32/3D□

MT-32 (Terminal type: Screw / Degree of protection: IP20)

Setting range (A)	Ordering type	Contactor	Separate mounting unit
	Differential		
1~1.6	MT-32/3D1.3	MC-9b MC-12b MC-18b MC-22b MC-32a MC-40a	UZ-32
1.6~2.5	MT-32/3D2.1		
2.5~4	MT-32/3D3.3		
4~6	MT-32/3D5		
5~8	MT-32/3D6.5		
6~9	MT-32/3D7.5		
7~10	MT-32/3D8.5		
9~13	MT-32/3D11		
12~18	MT-32/3D15		
16~22	MT-32/3D19		
18~25	MT-32/3D21.5		
22~32	MT-32/3D27		
28~40	MT-32/3D34		

Overload relay ordering types

Trip class 20A



MT-63/ S



MT-63/ L

MT-63 (Terminal type: Screw(S), Lug(L) / Degree of protection: IP20)

Setting range (A)	Ordering type	Contactor	Separate mounting unit
	Differential		
4~6	MT-63/3D5S/L	MC-50a MC-65a	UZ-63S/L
5~8	MT-63/3D6.5S/L		
6~9	MT-63/3D7.5S/L		
7~10	MT-63/3D8.5S/L		
9~13	MT-63/3D11S/L		
12~18	MT-63/3D15S/L		
16~22	MT-63/3D19S/L		
18~25	MT-63/3D21.5S/L		
24~36	MT-63/3D30S/L		
28~40	MT-63/3D34S/L		
34~50	MT-63/3D42S/L		
45~65	MT-63/3D55S/L		



MT-95/ S



MT-95/ L

MT-95 (Terminal type: Screw(S), Lug(L) / Degree of protection: IP20)

Setting range (A)	Ordering type	Contactor	Separate mounting unit
	Differential		
7~10	MT-95/3D8.5S/L	MC-75a MC-85a MC-100a	UZ-95S/L
9~13	MT-95/3D11S/L		
12~18	MT-95/3DK15S/L		
16~22	MT-95/3D19S/L		
18~25	MT-95/3D21.5S/L		
24~36	MT-95/3D30S/L		
28~40	MT-95/3D34S/L		
34~50	MT-95/3D42S/L		
45~65	MT-95/3D55S/L		
54~75	MT-95/3D65S/L		
63~85	MT-95/3D74S/L		
70~95	MT-95/3D83S/L		
80~100	MT-95/3D90S/L		



MT-150/ S

MT-150 (Terminal type: Screw(S), Lug(L) / Degree of protection: IP20)

Setting range (A)	Ordering type	Contactor	Separate mounting unit
	Differential		
34~50	MT-150/3D42S/L	MC-130a MC-150a	UZ-150S/L
45~65	MT-150/3D55S/L		
54~75	MT-150/3D65S/L		
63~85	MT-150/3D74S/L		
80~105	MT-150/3D93S/L		
95~130	MT-150/3D113S/L		
110~150	MT-150/3D130S/L		



MT-225/3D

MT-225 (Terminal type: Screw / Degree of protection: IP20)

Setting range (A)	Ordering type	Contactor	Remarks
	Differential		
65~100	MT-225/3D80	MC-185a MC-225a	-
85~125	MT-225/3D107		
100~160	MT-225/3D130		
120~185	MT-225/3D153		
160~240	MT-225/3D200		



MT-400/3D

MT-400 (Terminal type: Screw / Degree of protection: IP20)

Setting range (A)	Ordering type	Contactor	Remarks
	Differential		
85~125	MT-400/3D107	MC-265a MC-330a MC-400a	-
100~160	MT-400/3D130		
120~185	MT-400/3D153		
160~240	MT-400/3D200		
200~330	MT-400/3D265		
260~400	MT-400/3D350		



MT-800/3D

MT-800 (Terminal type: Screw / Degree of protection: IP20)

Setting range (A)	Ordering type	Contactor	Remarks
	Differential		
200~330	MT-800/3D265	MC-500a MC-630a MC-800a	-
260~400	MT-800/3D350		
400~630	MT-800/3D515		
520~800	MT-800/3D660		

Overload relay trip curves

Class 10A, 18AF

- MT-12/2H
- MT-12/3H
- MT-12/3K

Cold starting

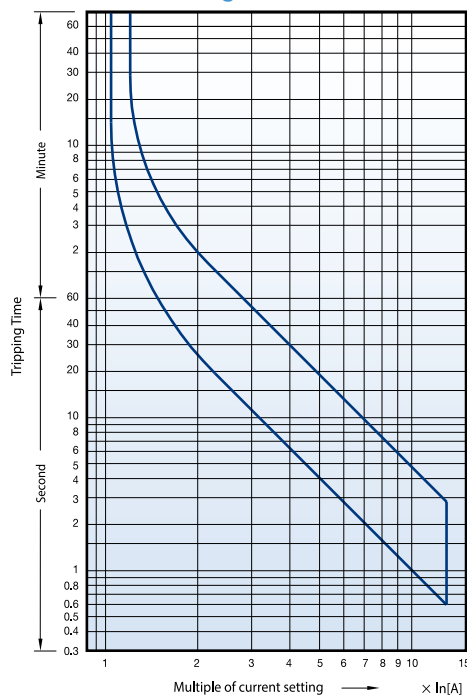

Hot starting

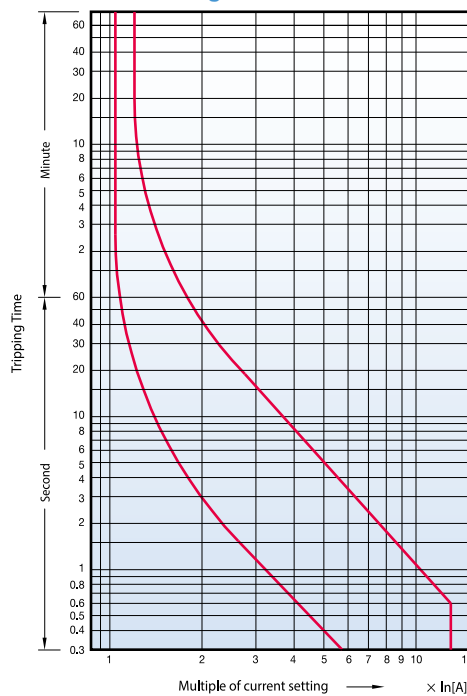

Class 20, 18AF

- MT-12/3D

Cold starting

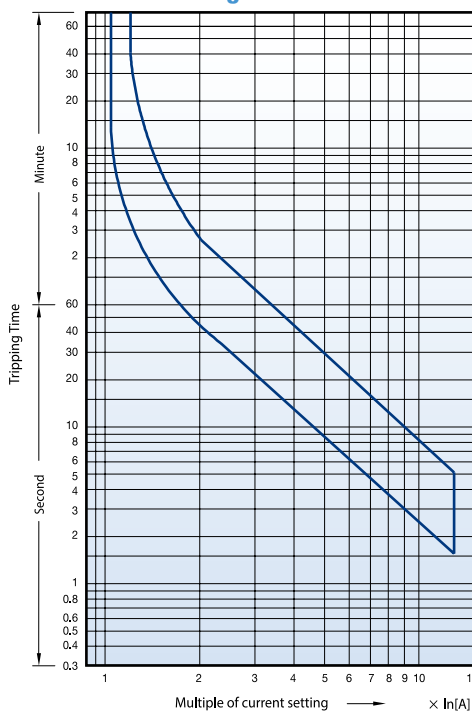

Hot starting

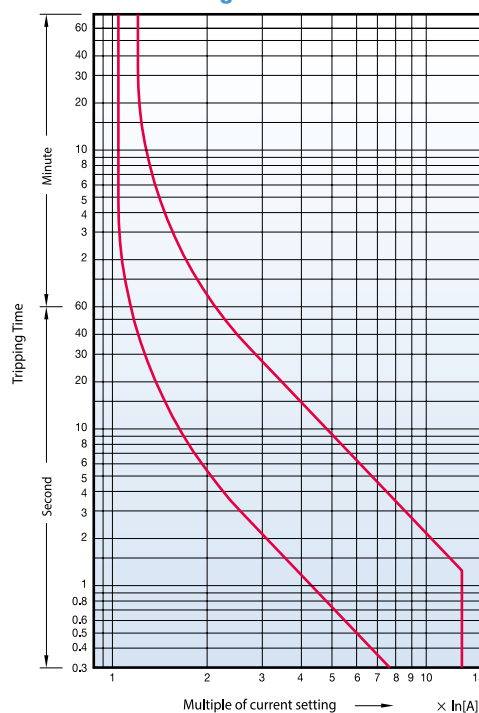

Class 10A, 40AF

- MT-32/2H
- MT-32/3H
- MT-32/3K

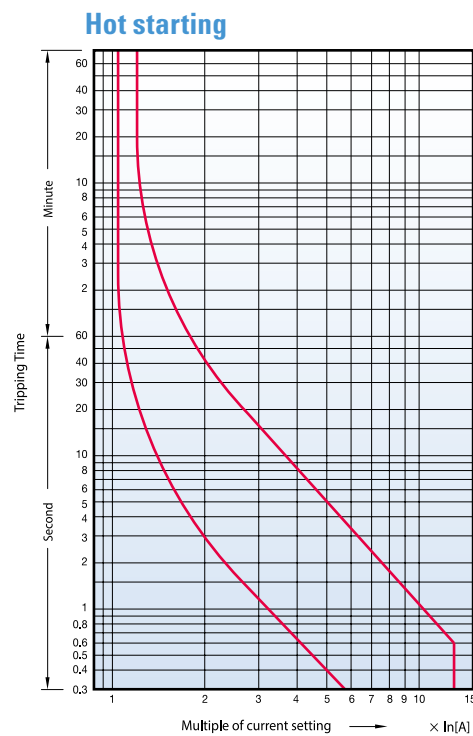
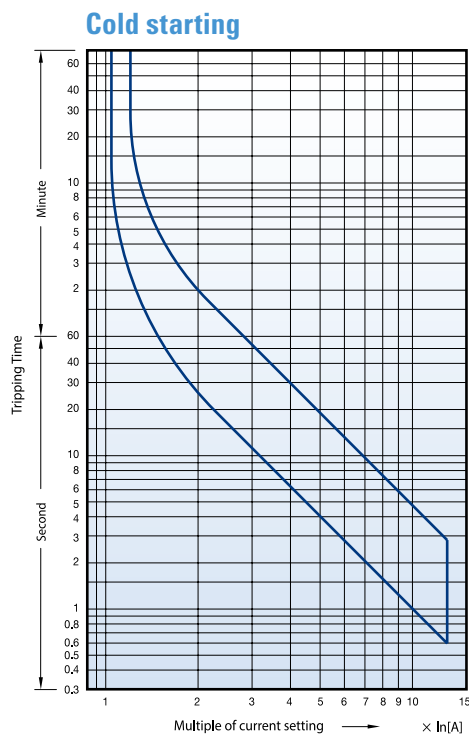

Class 20, 40AF

- MT-32/3D

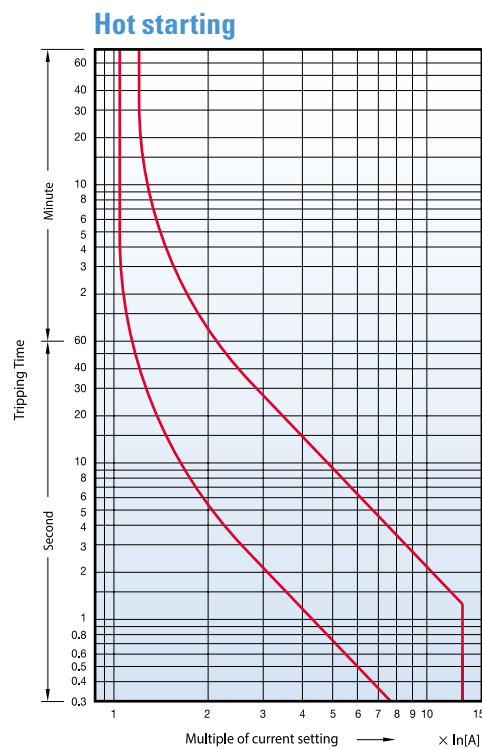
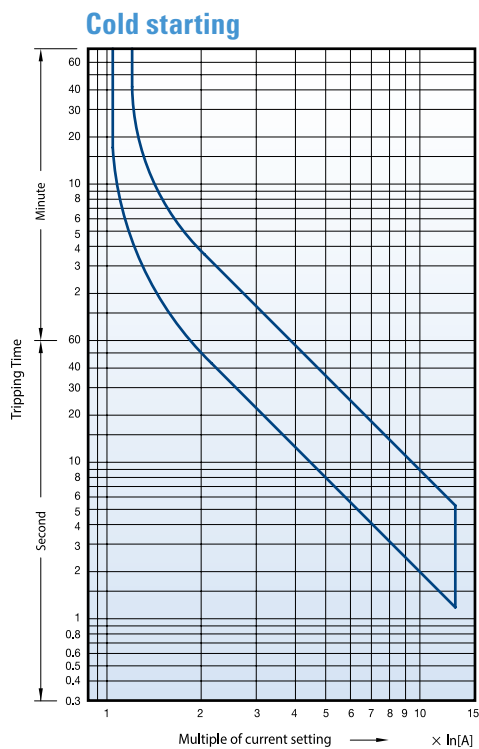

Overload relay trip curves

Class 10A, 65AF

- MT-63/2H
- MT-63/3H
- MT-63/3K

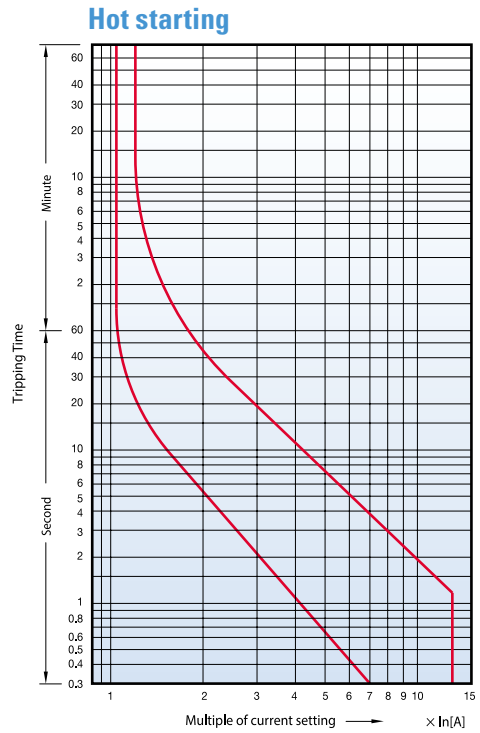
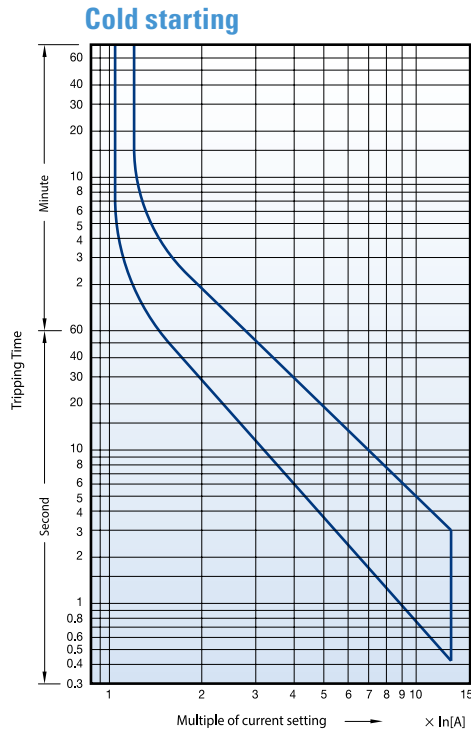

Class 20, 65AF

- MT-63/3D

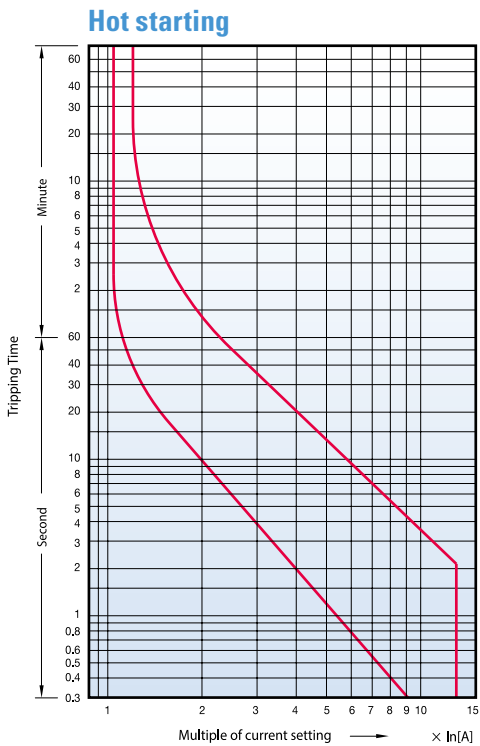
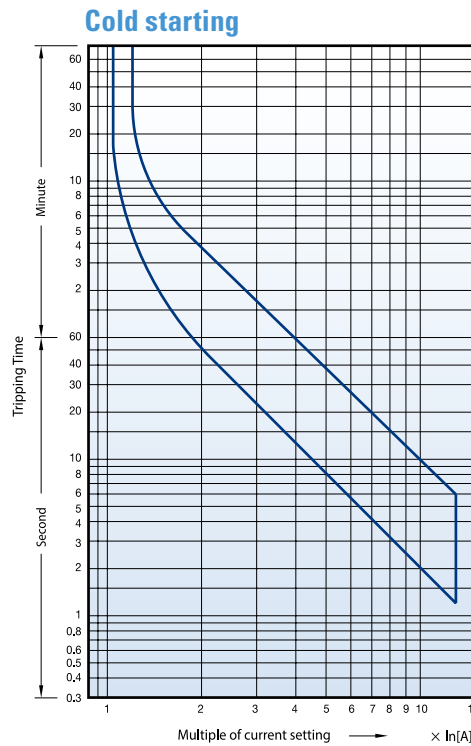

Class 10A, 100AF

- MT-95/2H
- MT-95/3H
- MT-95/3K

Cold starting

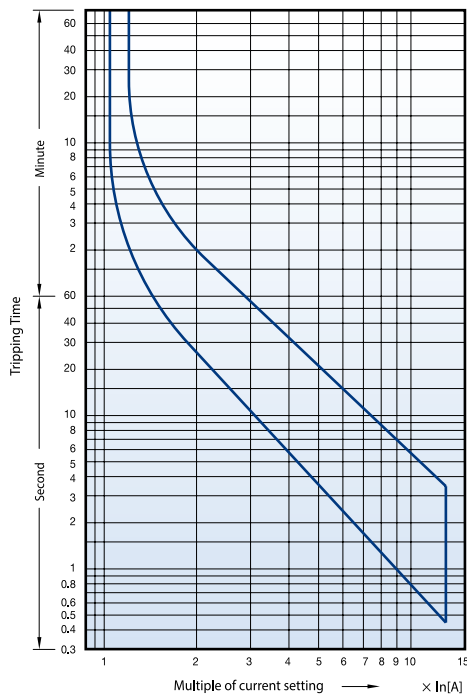

Hot starting

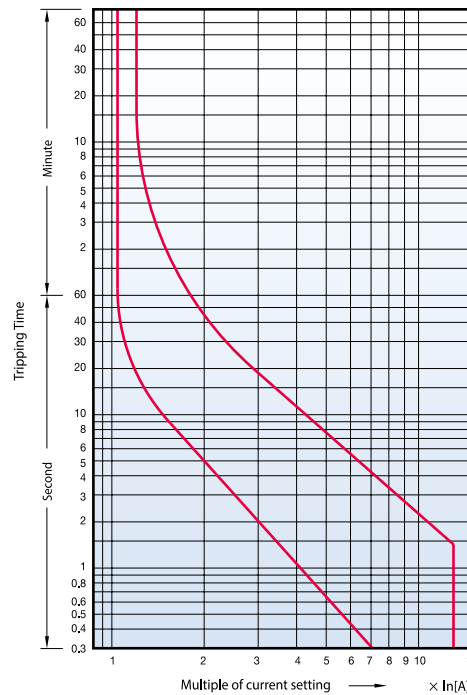

Class 20, 100AF

- MT-95/3D

Cold starting

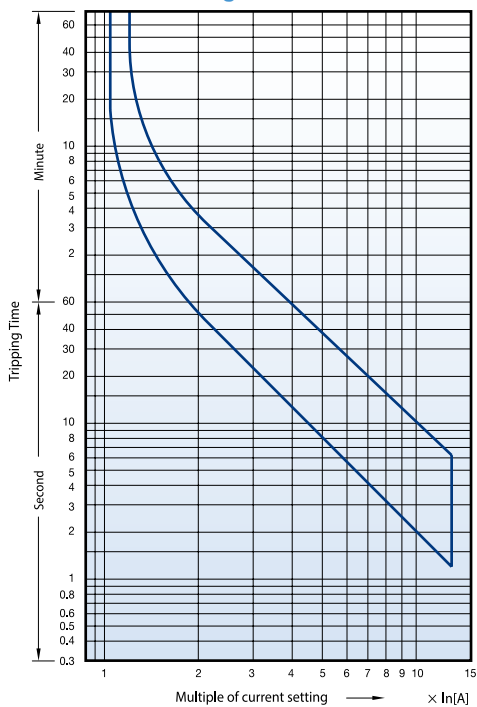

Hot starting

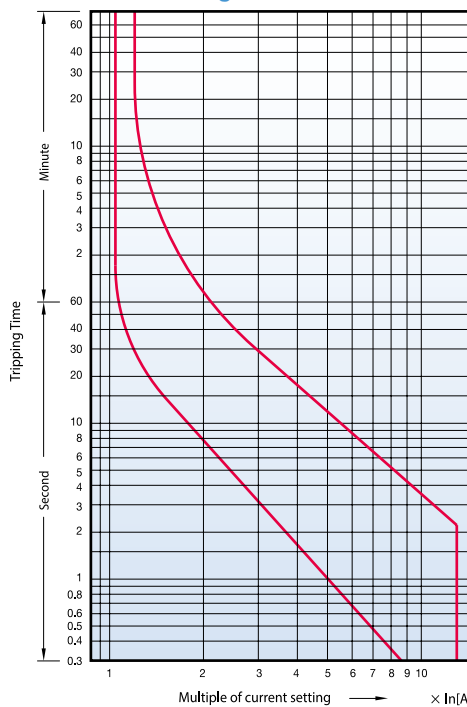

Overload relay trip curves

Class 10A, 150AF

- MT-150/2H
- MT-150/3H
- MT-150/3K

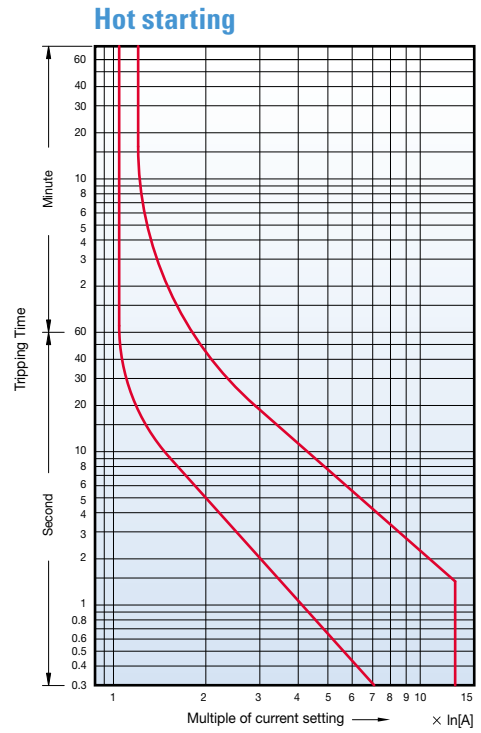
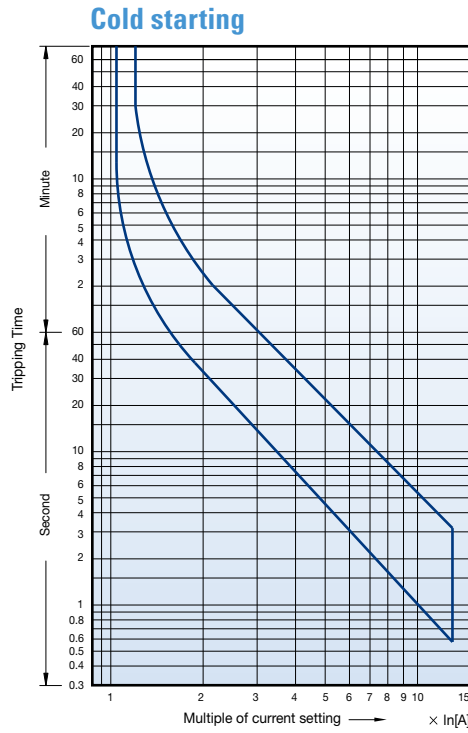

Class 20, 150AF

- MT-150/3D

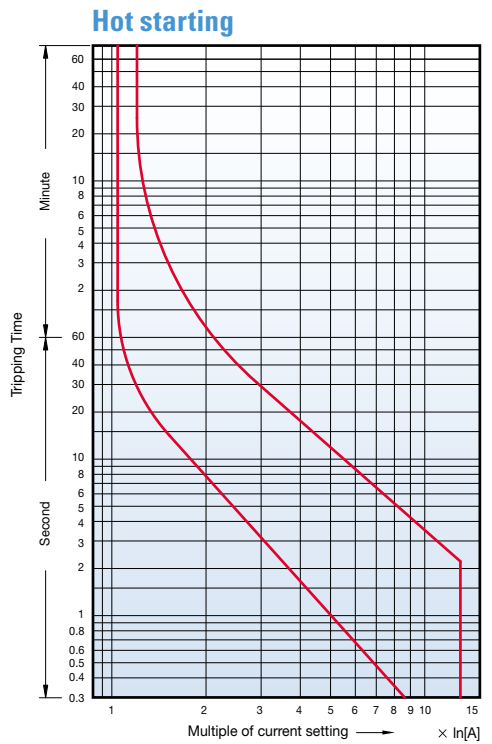
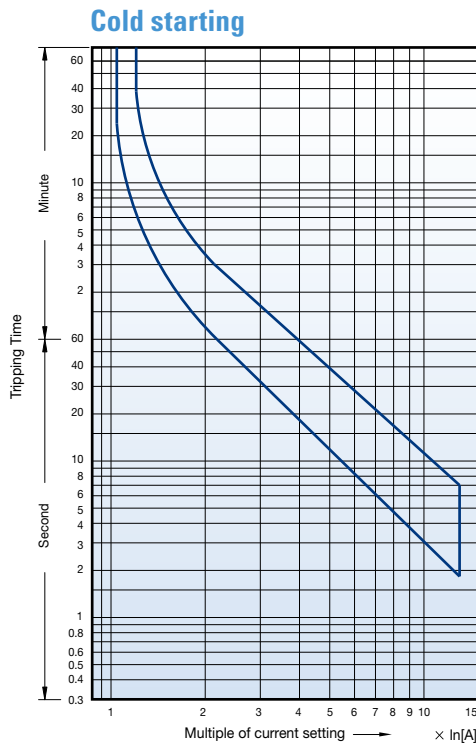

Class 10A, 225AF

- MT-225/2H
- MT-225/3H
- MT-225/3K

Cold starting

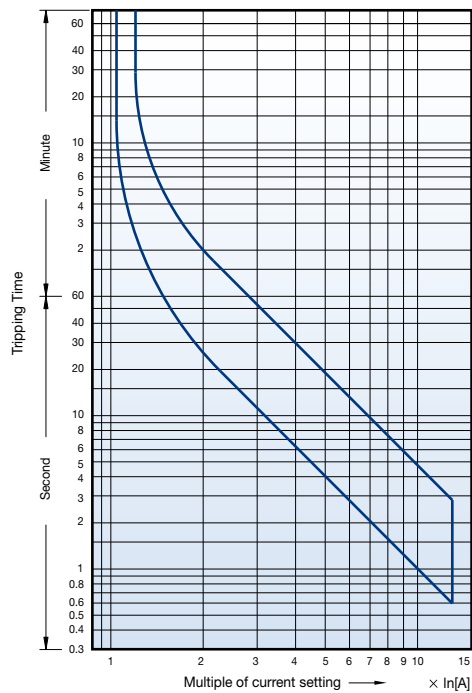

Hot starting

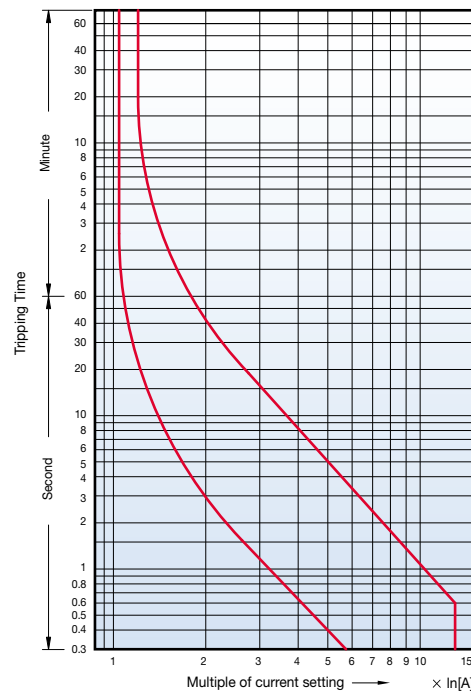

Class 20, 225AF

- MT-225/3D

Cold starting

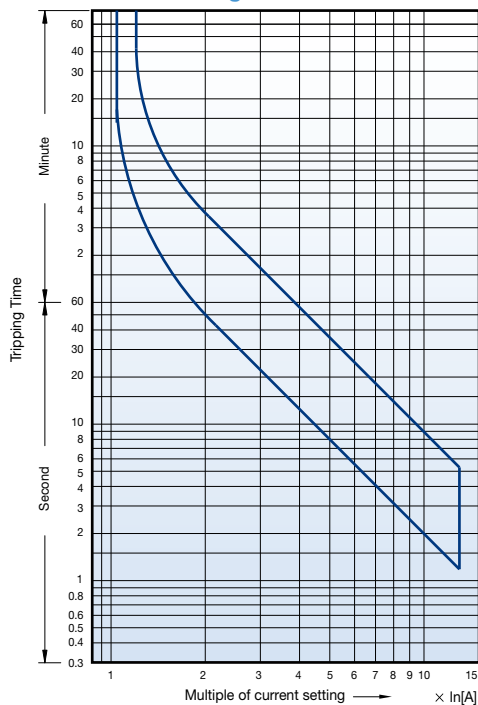

Hot starting

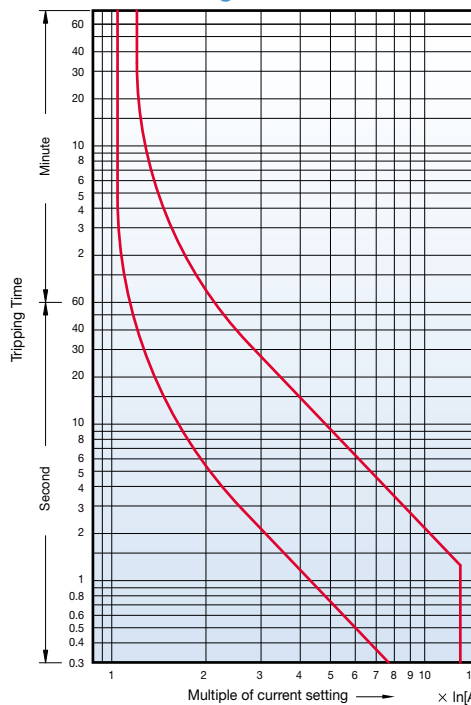

Overload relay trip curves

Class 10A, 400AF

- MT-400/2H
- MT-400/3H
- MT-400/3K

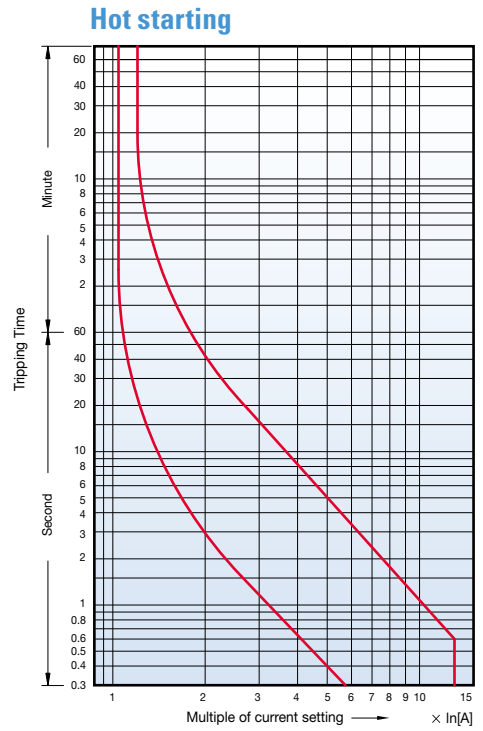
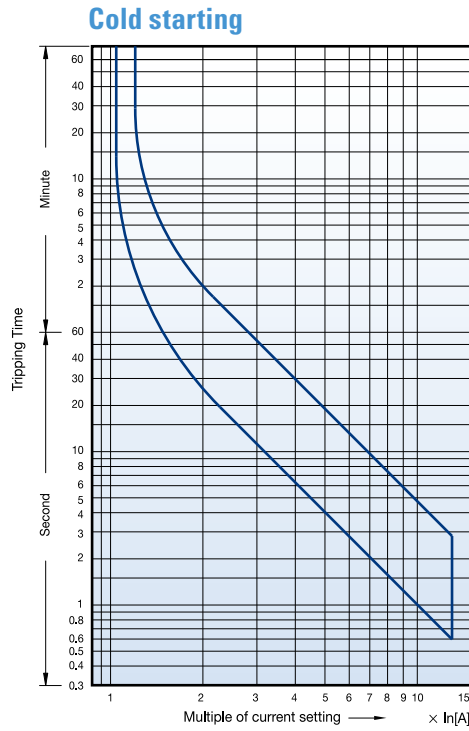

Class 20, 400AF

- MT-400/3D

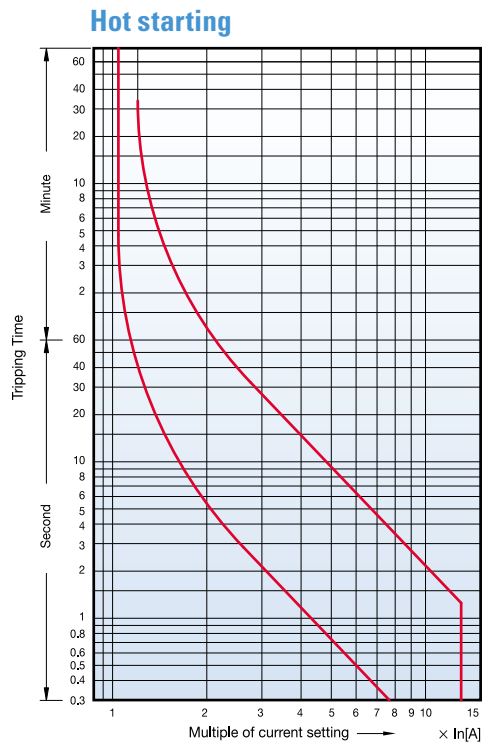
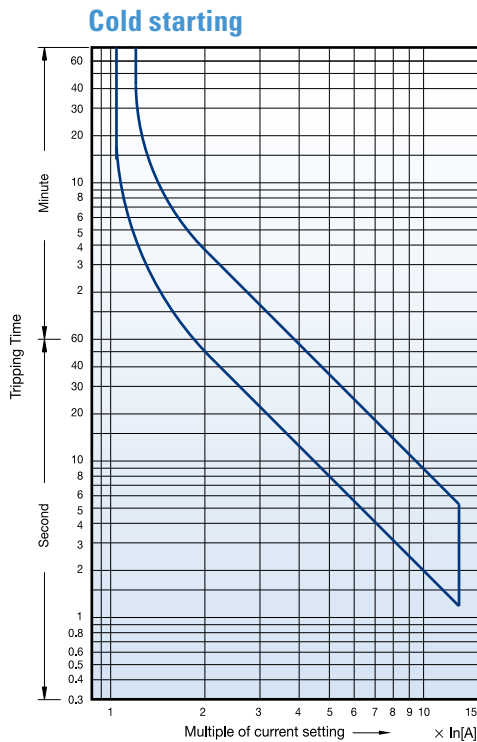

Class 10A, 800AF

- MT-800/2H
- MT-800/3H
- MT-800/3K

Cold starting

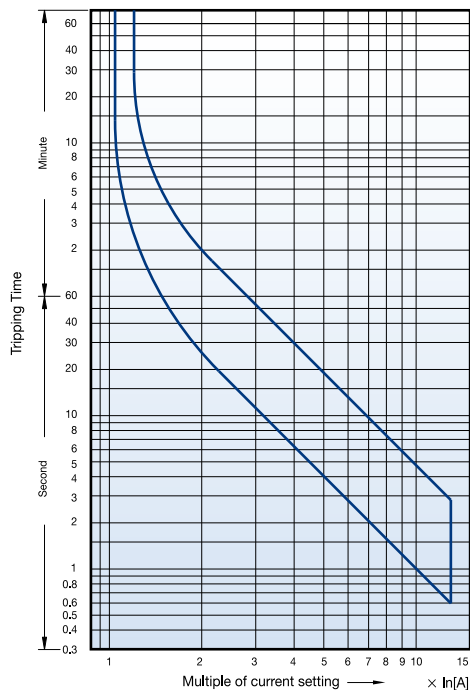

Hot starting

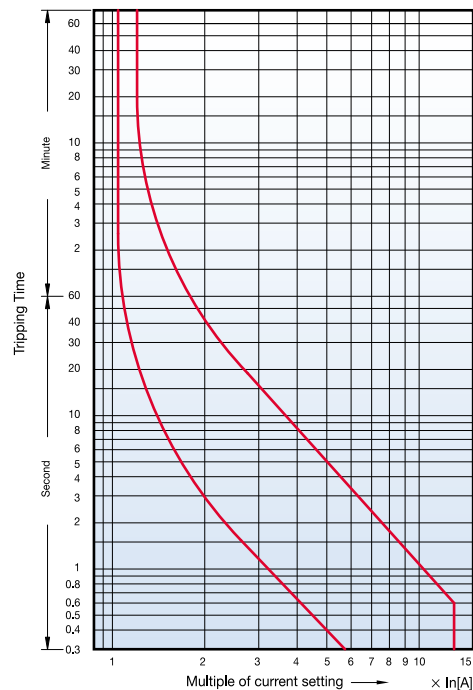

Class 20, 800AF

- MT-800/3D

Cold starting

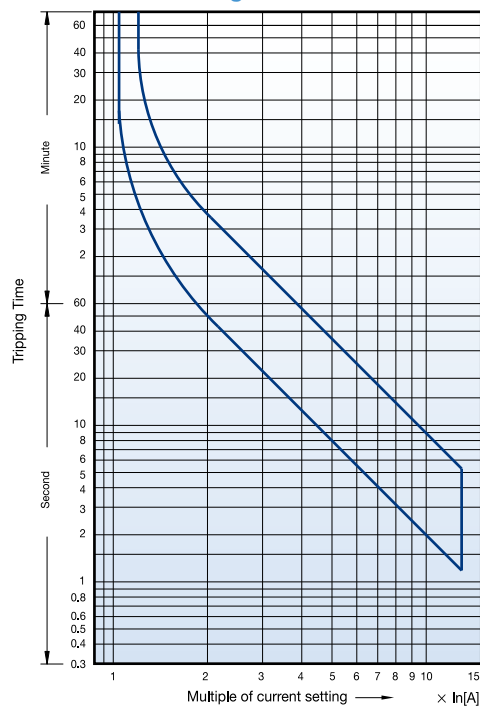

Hot starting

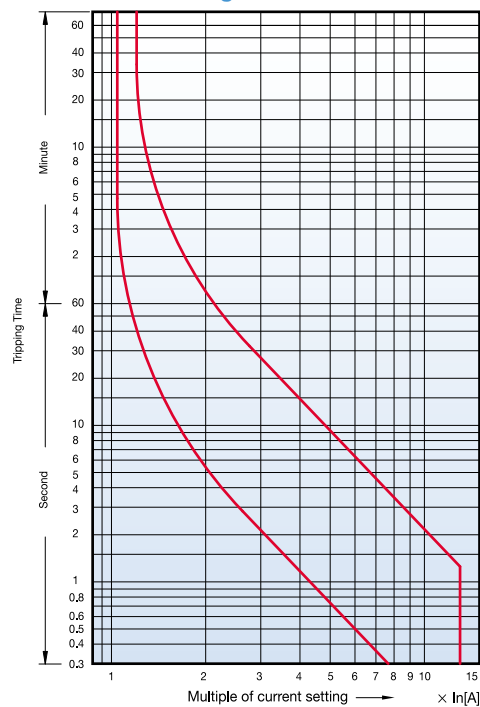

Type 2 coordination

440V

Susol MCCB N-type

Rated operational power		Circuit breaker		Contactor	Thermal overload relays		Short circuit breaking capacity	
kW	Current [A]	Type	Rating [A]	Type	Type	Setting range [A]	Ir [kA]	Iq [kA]
	440V							
1.1	2.37	TS100N	16	MC-12b	MT-32	2.5~4	1	50
1.5	3.06	TS100N	16	MC-18b	MT-32	2.5~4	1	50
2.2	4.42	TS100N	16	MC-22b	MT-32	4~6	1	50
3	5.77	TS100N	16	MC-22b	MT-32	5~8	1	50
4	7.90	TS100N	16	MC-32a	MT-32	6~9	1	50
5.5	10.40	TS100N	16	MC-32a	MT-32	9~13	3	50
7.5	13.70	TS100N	20	MC-32a	MT-32	12~18	3	50
11	20.10	TS100N	32	MC-40a	MT-32	18~25	3	50
15	26.50	TS100N	40	MC-40a	MT-32	22~32	3	50
18.5	32.80	TS100N	40	MC-50a	MT-63	28~40	3	50
22	39.00	TS100N	50	MC-50a	MT-63	34~50	3	50
30	51.50	TS100N	63	MC-65a	MT-63	45~65	3	50
37	64.00	TS100N	80	MC-75a	MT-95	54~75	5	50
45	76.00	TS100N	100	MC-85a	MT-95	63~85	5	50
55	90.00	TS100N	100	MC-100a	MT-95	70~95	5	50
59	97.00	TS160N	100	MC-130a	MT-150	80~105	5	50
75	125	TS160N	160	MC-150a	MT-150	110~150	10	50
90	146	TS160N	160	MC-185a	MT-225	120~185	10	50
110	178	TS250N	200	MC-185a	MT-225	160~240	10	50
132	215	TS250N	250	MC-225a	MT-225	160~240	10	65
160	256	TS400N	300	MC-400a	MT-400	200~330	18	65
200	330	TS400N	400	MC-400a	MT-400	260~400	18	65
220	353	TS400N	400	MC-400a	MT-400	260~400	18	65
250	401	TS630N	500	MC-630a	MT-800	260~400	18	65
300	481	TS630N	500	MC-630a	MT-800	400~630	18	65

440V

Susol MCCB H-type

Rated operational power		Circuit breaker		Contactor	Thermal overload relays		Short circuit breaking capacity	
kW	Current [A]	Type	Rating [A]	Type	Type	Setting range [A]	I _r [kA]	I _q [kA]
	440V							
1.1	2.37	TS100H	16	MC-12b	MT-32	2.5~4	1	50
1.5	3.06	TS100H	16	MC-18b	MT-32	2.5~4	1	50
2.2	4.42	TS100H	16	MC-22b	MT-32	4~6	1	50
3	5.77	TS100H	16	MC-22b	MT-32	5~8	1	50
4	7.90	TS100H	16	MC-32a	MT-32	6~9	1	50
5.5	10.40	TS100H	16	MC-32a	MT-32	9~13	3	50
7.5	13.70	TS100H	20	MC-32a	MT-32	12~18	3	70
11	20.10	TS100H	32	MC-40a	MT-32	18~25	3	70
15	26.50	TS100H	40	MC-40a	MT-32	22~32	3	70
18.5	32.80	TS100H	40	MC-50a	MT-63	28~40	3	70
22	39.00	TS100H	50	MC-50a	MT-63	34~50	3	70
30	51.50	TS100H	63	MC-65a	MT-63	45~65	3	70
37	64.00	TS100H	80	MC-75a	MT-95	54~75	5	70
45	76.00	TS100H	100	MC-85a	MT-95	63~85	5	70
55	90.00	TS100H	100	MC-100a	MT-95	70~95	5	70
59	97.00	TS160H	100	MC-130a	MT-150	80~105	5	70
75	125	TS160H	160	MC-150a	MT-150	110~150	10	70
90	146	TS160H	160	MC-185a	MT-225	120~185	10	70
110	178	TS250H	200	MC-185a	MT-225	160~240	10	70
132	215	TS250H	250	MC-225a	MT-225	160~240	10	70
160	256	TS400H	300	MC-400a	MT-400	200~330	18	85
200	330	TS400H	400	MC-400a	MT-400	260~400	18	85
220	353	TS400H	400	MC-400a	MT-400	260~400	18	85
250	401	TS630H	500	MC-630a	MT-800	260~400	18	85
300	481	TS630H	500	MC-630a	MT-800	400~630	18	100

Type 2 Coordination

440V

Susol MCCB L-type

Rated operational power		Circuit breaker		Contactor	Thermal overload relays		Short circuit breaking capacity	
kW	Current [A]	Type	Rating [A]	Type	Type	Setting range [A]	Ir [kA]	Iq [kA]
	440V							
1.1	2.37	TS100L	16	MC-12b	MT-32	2.5~4	1	50
1.5	3.06	TS100L	16	MC-18b	MT-32	2.5~4	1	50
2.2	4.42	TS100L	16	MC-22b	MT-32	4~6	1	50
3	5.77	TS100L	16	MC-22b	MT-32	5~8	1	50
4	7.90	TS100L	16	MC-32a	MT-32	6~9	1	50
5.5	10.40	TS100L	16	MC-32a	MT-32	9~13	3	50
7.5	13.70	TS100L	20	MC-32a	MT-32	12~18	3	100
11	20.10	TS100L	32	MC-40a	MT-32	18~25	3	100
15	26.50	TS100L	40	MC-40a	MT-32	22~32	3	100
18.5	32.80	TS100L	40	MC-50a	MT-63	28~40	3	130
22	39.00	TS100L	50	MC-50a	MT-63	34~50	3	130
30	51.50	TS100L	63	MC-65a	MT-63	45~65	3	130
37	64.00	TS100L	80	MC-75a	MT-95	54~75	5	130
45	76.00	TS100L	100	MC-85a	MT-95	63~85	5	130
55	90.00	TS100L	100	MC-100a	MT-95	70~95	5	130
59	97.00	TS160L	100	MC-130a	MT-150	80~105	5	130
75	125	TS160L	160	MC-150a	MT-150	110~150	10	130
90	146	TS160L	160	MC-185a	MT-225	120~185	10	130
110	178	TS250L	200	MC-185a	MT-225	160~240	10	130
132	215	TS250L	250	MC-225a	MT-225	160~240	10	130
160	256	TS400L	300	MC-400a	MT-400	200~330	18	130
200	330	TS400L	400	MC-400a	MT-400	260~400	18	130
220	353	TS400L	400	MC-400a	MT-400	260~400	18	130
250	401	TS630L	500	MC-630a	MT-800	260~400	18	130
300	481	TS630L	500	MC-630a	MT-800	400~630	18	130

440V

Metasol MCCB N-type

Rated operational power		Circuit breaker		Contactor	Thermal overload relays		Short circuit breaking capacity	
kW	Current [A]	Type	Rating [A]	Type	Type	Setting range [A]	I _r [kA]	I _q [kA]
	440V							
1.1	2.37	ABN53c	15	MC-12b	MT-32	2.5~4	1	14
1.5	3.06	ABN53c	15	MC-18b	MT-32	2.5~4	1	14
2.2	4.42	ABN53c	15	MC-22b	MT-32	4~6	1	14
3.0	5.77	ABN53c	15	MC-22b	MT-32	5~8	1	14
4.0	7.90	ABN53c	15	MC-32a	MT-32	6~9	1	14
5.5	10.40	ABN53c	15	MC-32a	MT-32	9~13	3	14
7.5	13.70	ABN53c	20	MC-32a	MT-32	12~18	3	14
11.0	20.10	ABN103c	30	MC-40a	MT-32	18~25	3	18
15.0	26.50	ABN103c	40	MC-40a	MT-32	22~32	3	18
18.5	32.80	ABN103c	40	MC-50a	MT-63	28~40	3	18
22.0	39.00	ABN103c	50	MC-50a	MT-63	34~50	3	18
30.0	51.50	ABN103c	75	MC-65a	MT-63	45~65	3	18
37.0	64.00	ABN103c	75	MC-75a	MT-95	54~75	5	18
45.0	76.00	ABN103c	100	MC-85a	MT-95	63~85	5	18
55.0	90.00	ABN103c	100	MC-100a	MT-95	70~95	5	18
59.0	97.00	ABN103c	100	MC-130a	MT-150	80~105	5	18
75.0	125	ABN203c	150	MC-150a	MT-150	110~150	10	26
90.0	146	ABN203c	200	MC-185a	MT-225	120~185	10	26
110.0	178	ABN203c	200	MC-185a	MT-225	160~240	10	26
132.0	215	ABN203c	250	MC-225a	MT-225	160~240	10	26
160.0	256	ABN403c	300	MC-400a	MT-400	200~330	18	37
200.0	330	ABN403c	400	MC-400a	MT-400	260~400	18	37
220.0	353	ABN403c	400	MC-400a	MT-400	260~400	18	37
250.0	401	ABN803c	500	MC-630a	MT-800	260~400	18	37
300.0	481	ABN803c	500	MC-630a	MT-800	400~630	18	37

Type 2 Coordination

440V

Metasol MCCB S-type

Rated operational power		Circuit breaker		Contactor	Thermal overload relays		Short circuit breaking capacity	
kW	Current [A]	Type	Rating [A]	Type	Type	Setting range [A]	Ir [kA]	Iq [kA]
	440V							
1.1	2.37	ABS53c	15	MC-12b	MT-32	2.5~4	1	18
1.5	3.06	ABS53c	15	MC-18b	MT-32	2.5~4	1	18
2.2	4.42	ABS53c	15	MC-22b	MT-32	4~6	1	18
3.0	5.77	ABS53c	15	MC-22b	MT-32	5~8	1	18
4.0	7.90	ABS53c	15	MC-32a	MT-32	6~9	1	18
5.5	10.40	ABS53c	15	MC-32a	MT-32	9~13	3	18
7.5	13.70	ABS53c	20	MC-32a	MT-32	12~18	3	18
11.0	20.10	ABS103c	30	MC-40a	MT-32	18~25	3	37
15.0	26.50	ABS103c	40	MC-40a	MT-32	22~32	3	37
18.5	32.80	ABS103c	40	MC-50a	MT-63	28~40	3	37
22.0	39.00	ABS103c	50	MC-50a	MT-63	34~50	3	37
30.0	51.50	ABS103c	75	MC-65a	MT-63	45~65	3	37
37.0	64.00	ABS103c	75	MC-75a	MT-95	54~75	5	37
45.0	76.00	ABS103c	100	MC-85a	MT-95	63~85	5	37
55.0	90.00	ABS103c	100	MC-100a	MT-95	70~95	5	37
59.0	97.00	ABS103c	100	MC-130a	MT-150	80~105	5	37
75.0	125	ABS203c	150	MC-150a	MT-150	110~150	10	37
90.0	146	ABS203c	200	MC-185a	MT-225	120~185	10	37
110.0	178	ABS203c	200	MC-185a	MT-225	160~240	10	37
132.0	215	ABS203c	250	MC-225a	MT-225	160~240	10	37
160.0	256	ABS403c	300	MC-400a	MT-400	200~330	18	50
200.0	330	ABS403c	400	MC-400a	MT-400	260~400	18	50
220.0	353	ABS403c	400	MC-400a	MT-400	260~400	18	50
250.0	401	ABS803c	500	MC-630a	MT-800	260~400	18	65
300.0	481	ABS803c	500	MC-630a	MT-800	400~630	18	65

440V

Metasol MCCB H-type

Rated operational power		Circuit breaker		Contactor	Thermal overload relays		Short circuit breaking capacity	
kW	Current [A]	Type	Rating [A]	Type	Type	Setting range [A]	I _r [kA]	I _q [kA]
	440V							
1.1	2.37	ABH53c	15	MC-12b	MT-32	2.5~4	1	35
1.5	3.06	ABH53c	15	MC-18b	MT-32	2.5~4	1	35
2.2	4.42	ABH53c	15	MC-22b	MT-32	4~6	1	35
3	5.77	ABH53c	15	MC-22b	MT-32	5~8	1	35
4	7.90	ABH53c	15	MC-32a	MT-32	6~9	1	35
5.5	10.40	ABH53c	15	MC-32a	MT-32	9~13	3	35
7.5	13.70	ABH53c	20	MC-32a	MT-32	12~18	3	35
11	20.10	ABH103c	30	MC-40a	MT-32	18~25	3	50
15	26.50	ABH103c	40	MC-40a	MT-32	22~32	3	50
18.5	32.80	ABH103c	40	MC-50a	MT-63	28~40	3	50
22	39.00	ABH103c	50	MC-50a	MT-63	34~50	3	50
30	51.50	ABH103c	75	MC-65a	MT-63	45~65	3	50
37	64.00	ABH103c	75	MC-75a	MT-95	54~75	5	50
45	76.00	ABH103c	100	MC-85a	MT-95	63~85	5	50
55	90.00	ABH103c	100	MC-100a	MT-95	70~95	5	50
59	97.00	ABH103c	100	MC-130a	MT-150	80~105	5	50
75	125	ABH203c	150	MC-150a	MT-150	110~150	10	50
90	146	ABH203c	200	MC-185a	MT-225	120~185	10	50
110	178	ABH203c	200	MC-185a	MT-225	160~240	10	50
132	215	ABH203c	250	MC-225a	MT-225	160~240	10	50
160	256	ABL403c	300	MC-400a	MT-400	200~330	18	85
200	330	ABL403c	400	MC-400a	MT-400	260~400	18	85
220	353	ABL403c	400	MC-400a	MT-400	260~400	18	85
250	401	ABL803c	500	MC-630a	MT-800	260~400	18	85
300	481	ABL803c	500	MC-630a	MT-800	400~630	18	85

Type 2 coordination (MCi series)

Circuit breaker (ACB)			Contactor(MCi)		Short circuit
ACB type	CRADLE type	Rating(A)	Type	Rating(A)	I _r =I _q (kA)
AN-16C3-16A	AL-H16C3	1600	MCi-900	900	42
AN-16C3-16A	AL-H16C3	1600	MCi-1050	1050	42
AN-16C3-16A	AL-H16C3	1600	MCi-1260	1260	42
AH-32E3-32A	AL-H06~32E3	3200	MCi-1700	1700	42
AH-32E3-32A	AL-H06~32E3	3200	MCi-2100	2100	42
AH-32E3-32A	AL-H06~32E3	3200	MCi-2650	2650	42

* Breaker (ACB) Model AN-16C3-16A when the OCR Override setting is "On"

Rated UL 508 combination motor controller type-C

Metasol MS

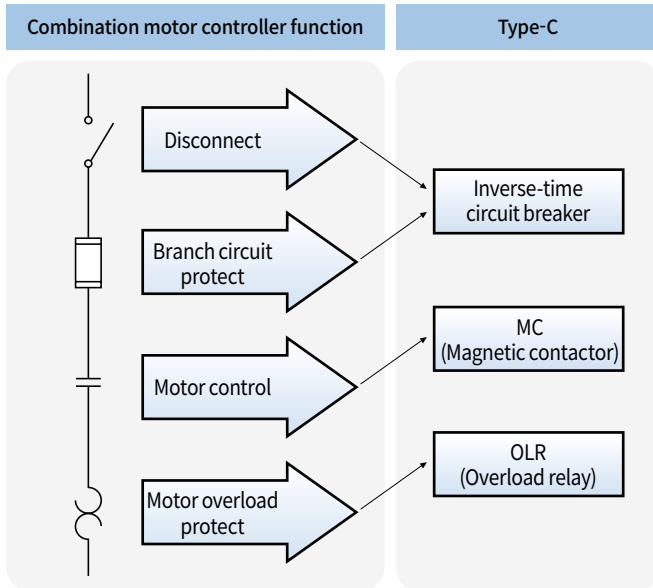

240V

Susol UL MCCB C-type

CB	MC	OLR	kA@240V	Maximum HP	Maximum NEC FLC [A]
UTE100E	MC-6a	MT-12 0.1~10A	50	3	9.6
UTE100N			65	3	
UTE100E	MC-9a	MT-12 0.1~10A	50	3	9.6
UTE100N			65	3	
UTE100E	MC-12a	MT-12 0.1~18A	50	5	15.2
UTE100N			65	5	
UTE100E	MC-18a	MT-12 0.1~18A	50	7.5	22
UTE100N			65	7.5	
UTS150N			65	7.5	
UTS150L			100	7.5	
UTE100E			50	7.5	
UTE100E	MC-9b	MT-32 0.1~10A	50	3	9.6
UTE100N			65	3	
UTE100E	MC-12b	MT-32 0.1~18A	50	5	15.2
UTE100N			65	5	
UTE100E	MC-18b	MT-32 0.1~25A	50	7.5	22
UTE100N			65	7.5	
UTS150N			65	7.5	
UTS150L			100	7.5	

CB	MC	OLR	kA@240V	Maximum HP	Maximum NEC FLC [A]
UTE100E	MC-22b	MT-32 0.1~32A	50	10	28
UTE100N			65	10	
UTS150N			65	10	
UTS150L			100	10	
UTE100E	MC-32a	MT-32 0.1~32A	50	10	28
UTE100N			65	10	
UTS150N			65	10	
UTS150L			100	10	
UTE100E	MC-40a	MT-32 0.1~40A	50	15	42
UTE100N			65	15	
UTS150N			65	15	
UTS150L			100	15	

Rated UL 508 combination motor controller type-C

240V

Susol UL MCCB C-type

CB	MC	OLR	kA@240V	Maximum HP	Maximum NEC FLC [A]	CB	MC	OLR	kA@240V	Maximum HP	Maximum NEC FLC [A]	
UTE100E	MC-6a	MT-12 0.1~10A	50	3	9.6	UTE100E	MC-65a	MT-63 4~65A	50	30	80	
UTE100N			65	3		UTE100N			65	30		
UTE100E	MC-9a	MT-12 0.1~10A	50	3	9.6	UTS150N			65	30		
UTE100N			65	3		UTS150L			100	30		
UTE100E	MC-12a	MT-12 0.1~18A	50	5	15.2	UTS150N	MC-75a	MT-95 7~95A	65	30	80	
UTE100N			65	5		UTS150L			100	30		
UTE100E	MC-18a	MT-12 0.1~18A	50	7.5	22	UTS150N	MC-85a	MT-95 7~100A	65	40	104	
UTE100N			65	7.5		UTS150L			100	40		
UTS150N			65	7.5		UTS150N	MC-100a	MT-95 7~100A	65	40	104	
UTS150L			100	7.5		UTS150L			100	40		
UTE100E	MC-9b	MT-32 0.1~10A	50	3	9.6	UTS150N	MC-130a	MT-150 34~130A	65	40	104	
UTE100N			65	3		UTS150L			100	40		
UTE100E	MC-12b	MT-32 0.1~18A	50	5	15.2	UTS150N	MC-150a	MT-150 34~130A	65	50	130	
UTE100N			65	5		UTS150L			100	50		
UTE100E	MC-18b	MT-32 0.1~25A	50	7.5	22	UTS250N			65	50		
UTE100N			65	7.5		UTS250L			100	50		
UTS150N			65	7.5		UTS250N	MC-185a	MT-225 65~185A	65	60	154	
UTS150L			100	7.5		UTS250L			100	60		
UTE100E	MC-22b	MT-32 0.1~32A	50	10	28	UTS400N	MC-225a	MT-225 65~240A	65	60	192	
UTE100N			65	10		UTS400L			65	75		
UTS150N			65	10		UTS250N	65		75			
UTS150L			100	10		UTS250L	100		75			
UTE100E	MC-32a	MT-32 0.1~32A	50	10	28	UTS400N	MC-265a	MT-400 85~330A	65	100	248	
UTE100N			65	10		UTS400L			100	100		
UTS150N			65	10		UTS400N	MC-330a	MT-400 85~330A	65	100	248	
UTS150L			100	10		UTS400L			100	100		
UTE100E	MC-40a	MT-32 0.1~40A	50	15	42	UTS600N	MC-400a	MT-400 85~400A	65	150	360	
UTE100N			65	15		UTS600L			100	150		
UTS150N			65	15		UTS800L	MC-500a	MT-800 200~600A	100	200	480	
UTS150L			100	15		UTS800L	MC-630a	MT-800 200~800A	100	250	604	
UTE100E	MC-50a	MT-63 4~65A	50	25	65							
UTE100N			65	25								
UTS150N			65	25								
UTS150L			100	25								

480V

Susol UL MCCB C-type

CB	MC	OLR	Voltage (V)	Short circuit rating (kA) (4)	Maximum HP	Maximum NEC FLC [A]
UTE100E	MC-6a	MT-12 0.1~10A	480	25	5	7.6
UTE100N			480	35	5	
UTE100E	MC-9a	MT-12 0.1~10A	480	25	5	7.6
UTE100N			480	35	5	
UTE100E	MC-12a	MT-12 0.1~13A	480	25	7.5	11
UTE100N			480	35	7.5	
UTE100E	MC-18a	MT-12 0.1~18A	480	25	10	14
UTE100N			480	35	10	
UTS150N			480	35	10	
UTS150H			480	65	10	
UTS150L			480	100	10	
UTE100E	MC-9b	MT-32 0.1~10A	480	25	5	7.6
UTE100N			480	35	5	
UTE100E	MC-12b	MT-32 0.1~13A	480	25	7.5	11
UTE100N			480	35	7.5	
UTE100E	MC-18b	MT-32 0.1~18A	480	25	10	14
UTE100N			480	35	10	
UTE100E	MC-22b	MT-32 0.1~25A	480	25	15	21
UTE100N			480	35	15	
UTS150N			480	35	15	
UTS150H			480	65	15	
UTS150L			480	100	15	
UTE100E	MC-32a	MT-32 0.1~32A	480	25	20	27
UTE100N			480	35	20	
UTS150N			480	35	20	
UTS150H			480	65	20	
UTE100E	MC-40a	MT-32 0.1~40A	480	25	30	40
UTE100N			480	35	30	
UTS150N			480	35	30	
UTS150H			480	65	30	
UTS150L			480	100	30	
UTE100E	MC-50a	MT-63 4~65A	480	25	40	52
UTE100N			480	35	40	
UTS150N			480	35	40	
UTS150H			480	65	40	
UTS150L			480	100	40	
UTE100E	MC-65a	MT-63 4~65A	480	25	50	65
UTE100N			480	35	50	
UTS150N			480	35	50	
UTS150H			480	65	50	
UTS150L			480	100	50	

CB	MC	OLR	Voltage (V)	Short circuit rating (kA) (4)	Maximum HP	Maximum NEC FLC [A]
UTS150N	MC-75a	MT-95 7~75A	480	35	50	65
UTS150H			480	65	50	
UTS150L			480	100	50	
UTS150N	MC-85a	MT-95 7~85A	480	35	60	77
UTS150H			480	65	60	
UTS150L			480	100	60	
UTS150N	MC-100a	MT-95 7~100A	480	35	75	96
UTS150H			480	65	75	
UTS150L			480	100	75	
UTS150N	MC-130a	MT-150 34~130A	480	35	75	96
UTS150H			480	65	75	
UTS150L	MC-150a	MT-150 34~130A	480	100	75	124
UTS150N			480	35	100	
UTS150H			480	65	100	
UTS150L			480	100	100	
UTS250N			480	35	100	
UTS250H			480	65	100	
UTS250L			480	100	100	
UTS250N	MC-185a	MT-225 65~185A	480	35	125	156
UTS250H			480	65	125	
UTS250L			480	100	125	
UTS400N			480	35	150	
UTS400H			480	65	150	
UTS400L	MC-225a	MT-225 65~240A	480	100	150	180
UTS250N			480	35	125	
UTS250H			480	65	125	
UTS250L			480	100	125	
UTS400N	MC-265a	MT-400 85~330A	480	35	150	240
UTS400H			480	65	200	
UTS400L			480	100	200	
UTS400N	MC-330a	MT-400 85~330A	480	35	200	302
UTS400H			480	65	200	
UTS400L			480	100	200	
UTS600N	MC-400a	MT-400 85~400A	480	35	300	361
UTS600H			480	65	300	
UTS600L			480	100	300	
UTS800H	MC-500a	MT-800 200~600A	480	65	400	477
UTS800L			480	100	400	
UTS800H	MC-630a	MT-800 200~800A	480	65	500	590
UTS800L	MC-630a		480	100	500	

Rated UL 508 combination motor controller type-C

600V

Susol UL MCCB C-type

CB	MC	OLR	Voltage (V)	Maximum HP	Maximum HP	Maximum NEC FLC [A]
UTE100E	MC-6a	MT-12 0.1~10A	600Y/347	14	7.5	9
UTE100N			600Y/347	18	7.5	
UTE100E	MC-9a	MT-12 0.1~10A	600Y/347	14	7.5	9
UTE100N			600Y/347	18	7.5	
UTE100E	MC-12a	MT-12 0.1~13A	600Y/347	14	10	11
UTE100N			600Y/347	18	10	
UTE100E	MC-18a	MT-12 0.1~18A	600Y/347	14	15	17
UTE100N			600Y/347	18	15	
UTS150N			600	18	15	
UTS150H			600	35	15	
UTS150L			600	50	15	
UTE100E			600Y/347	14	7.5	
UTE100N	600Y/347	18	7.5			
UTE100E	MC-12b	MT-32 0.1~13A	600Y/347	14	10	11
UTE100N			600Y/347	18	10	
UTE100E	MC-18b	MT-32 0.1~18A	600Y/347	14	15	17
UTE100N			600Y/347	18	15	
UTE100E	MC-22b	MT-32 0.1~25A	600Y/347	14	20	22
UTE100N			600Y/347	18	20	
UTS150N			600	18	20	
UTS150H			600	35	20	
UTS150L			600	50	20	
UTE100E			MC-32a	MT-32 0.1~32A	600Y/347	
UTE100N	600Y/347	18			25	
UTS150N	600	18			25	
UTS150H	600	35			25	
UTS150L	600	50			25	
UTE100E	MC-40a	MT-32 0.1~32A			600Y/347	14
UTE100N			600Y/347	18	30	
UTS150N			600	18	30	
UTS150H			600	35	30	
UTS150L			600	50	30	
UTE100E			MC-50a	MT-63 4~65A	600Y/347	14
UTE100N	600Y/347	18			50	
UTS150N	600	18			50	
UTS150H	600	35			50	
UTS150L	600	50			50	
UTE100E	MC-65a	MT-63 4~65A			600Y/347	14
UTE100N			600Y/347	18	60	
UTS150N			600	18	60	
UTS150H			600	35	60	
UTS150L			600	50	60	

CB	MC	OLR	Voltage (V)	Maximum HP	Maximum HP	Maximum NEC FLC [A]
UTS150N	MC-75a	MT-95 7~75A	600	18	60	62
UTS150H			600	35	60	
UTS150L			600	50	60	
UTS150N	MC-85a	MT-95 7~85A	600	18	75	77
UTS150H			600	35	75	
UTS150L			600	50	75	
UTS150N	MC-100a	MT-95 7~85A	600	18	75	77
UTS150H			600	35	75	
UTS150L			600	50	75	
UTS150N	MC-130a	MT-150 34~85A	600	18	75	77
UTS150H			600	35	75	
UTS150L			600	50	75	
UTS150N	MC-150a	MT-150 34~85A	600	18	75	77
UTS150H			600	35	75	
UTS150L			600	50	75	
UTS250N	MC-185a	MT-150 65~185A	600	18	125	125
UTS250H			600	35	125	
UTS250L			600	50	125	
UTS400N			600	18	150	
UTS400H			600	35	150	
UTS400L			600	50	150	
UTS250N	MC-225a	MT-225 65~185A	600	18	125	144
UTS250H			600	35	125	
UTS250L			600	50	125	
UTS400N			600	18	150	
UTS400H			600	35	150	
UTS400L			600	50	150	
UTS400N	MC-265a	MT-400 85~240A	600	18	200	192
UTS400H			600	35	200	
UTS400L			600	50	200	
UTS400N	MC-330a	MT-400 85~330A	600	18	200	242
UTS400H			600	35	200	
UTS400L			600	50	200	
UTS600N	MC-400a	MT-400 85~400A	600	18	300	289
UTS600H			600	35	300	
UTS600L			600	50	300	
UTS800H	MC-500a	MT-800 200~400A	600	35	400	382
UTS800L			600	50	400	
UTS800H	MC-630a	MT-800 200~600A	600	35	500	472
UTS800L			600	50	500	

Rated UL 508 combination motor controller type-D Metasol MS

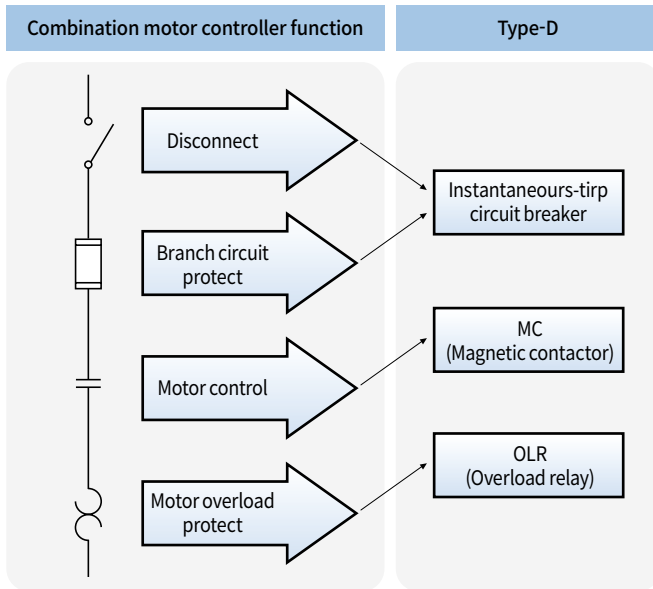

240V

Susol UL MCCB D-type

CB	MC	OLR	kA@240V	Maximum HP	Maximum NEC FLC [A]
UTS150L MCP	MC-6a	MT-12 0.1~10A	100	3	9.6
UTS150L MCP	MC-9a	MT-12 0.1~10A	100	3	9.6
UTS150L MCP	MC-12a	MT-12 0.1~18A	100	5	15.2
UTS150L MCP	MC-18a	MT-12 0.1~18A	100	7.5	22
UTS150L MCP	MC-9b	MT-32 0.1~10A	100	3	9.6
UTS150L MCP	MC-12b	MT-32 0.1~18A	100	5	15.2
UTS150L MCP	MC-18b	MT-32 0.1~25A	100	7.5	22
UTS150L MCP	MC-22b	MT-32 0.1~32A	100	10	28
UTS150L MCP	MC-32a	MT-32 0.1~32A	100	10	28
UTS150L MCP	MC-40a	MT-32 0.1~40A	100	15	42
UTS150L MCP	MC-50a	MT-63 4~65A	100	25	65
UTS150L MCP	MC-65a	MT-63 4~65A	100	30	80
UTS150L MCP	MC-75a	MT-95 7~95A	100	30	80

CB	MC	OLR	kA@240V	Maximum HP	Maximum NEC FLC [A]
UTS150L MCP	MC-85a	MT-95 7~100A	100	40	104
UTS150L MCP	MC-100a	MT-95 7~100A	100	40	104
UTS150L MCP	MC-130a	MT-150 34~130A	100	40	104
UTS250L MCP	MC-150a	MT-150 34~130A	100	50	130
UTS250L MCP	MC-185a	MT-225 65~160A	100	60	154
UTS400L MCP	MC-185a	MT-225 65~185A	100	60	154
UTS250L MCP	MC-225a	MT-225 65~240A	100	75	192
UTS400L MCP	MC-225a	MT-225 65~240A	100	75	192
UTS400L MCP	MC-265a	MT-400 85~330A	100	100	248
UTS400L MCP	MC-330a	MT-400 85~330A	100	100	248
UTS600L MCP	MC-400a	MT-400 85~400A	100	150	360
UTS800L MCP	MC-500a	MT-800 200~600A	100	200	480
UTS800L MCP	MC-630a	MT-800 200~800A	100	250	604

Rated UL 508 combination motor controller type-D

480V

Susol UL MCCB D-type

CB	MC	OLR	kA@400V	Maximum HP	Maximum NEC FLC [A]
UTS150L MCP	MC-6a	MT-12 0.1~10A	65	5	7.6
UTS150L MCP	MC-9a	MT-12 0.1~10A	65	5	7.6
UTS150L MCP	MC-12a	MT-12 0.1~13A	65	7.5	11
UTS150L MCP	MC-18a	MT-12 0.1~18A	65	10	14
UTS150L MCP	MC-9b	MT-32 0.1~10A	65	5	7.6
UTS150L MCP	MC-12b	MT-32 0.1~13A	65	7.5	11
UTS150L MCP	MC-18b	MT-32 0.1~18A	65	10	14
UTS150L MCP	MC-22b	MT-32 0.1~25A	65	15	21
UTS150L MCP	MC-32a	MT-32 0.1~32A	65	20	27
UTS150L MCP	MC-40a	MT-32 0.1~40A	65	20	40
UTS150H MCP	MC-50a	MT-63 4~65A	65	40	52
UTS150L MCP	MC-50a	MT-63 4~65A	100	40	52
UTS150H MCP	MC-65a	MT-63 4~65A	65	50	65
UTS150L MCP	MC-65a	MT-63 4~65A	100	50	65
UTS150H MCP	MC-75a	MT-95 7~75A	65	50	65
UTS150L MCP	MC-75a	MT-95 7~75A	100	50	65
UTS150H MCP	MC-85a	MT-95 7~85A	65	60	77
UTS150L MCP	MC-85a	MT-95 7~85A	100	60	77
UTS150H MCP	MC-100a	MT-95 7~100A	65	75	96
UTS150L MCP	MC-100a	MT-95 7~100A	100	75	96

CB	MC	OLR	kA@400V	Maximum HP	Maximum NEC FLC [A]
UTS150H MCP	MC-130a	MT-150 34~130A	65	75	96
UTS150L MCP	MC-130a	MT-150 34~130A	100	75	96
UTS250H MCP	MC-150a	MT-150 34~130A	65	100	124
UTS250L MCP	MC-150a	MT-150 34~130A	100	100	124
UTS250H MCP	MC-185a	MT-225 65~185A	65	125	156
UTS250L MCP	MC-185a	MT-225 65~185A	85	125	156
UTS400H MCP	MC-185a	MT-225 65~185A	65	125	156
UTS400L MCP	MC-185a	MT-225 65~185A	100	125	156
UTS250H MCP	MC-225a	MT-225 65~240A	65	150	180
UTS250L MCP	MC-225a	MT-225 65~240A	85	150	180
UTS400H MCP	MC-225a	MT-225 65~240A	65	150	180
UTS400L MCP	MC-225a	MT-225 65~240A	100	150	180
UTS400H MCP	MC-265a	MT-400 85~330A	65	200	240
UTS400L MCP	MC-265a	MT-400 85~330A	100	200	240
UTS400H MCP	MC-330a	MT-400 85~330A	65	200	240
UTS400L MCP	MC-330a	MT-400 85~330A	100	200	240
UTS600H MCP	MC-400a	MT-400 85~400A	65	300	361
UTS600L MCP	MC-400a	MT-400 85~400A	100	300	361
UTS800L MCP	MC-500a	MT-800 200~600A	100	400	477
UTS800L MCP	MC-630a	MT-800 200~800A	100	500	590

600V

Susol UL MCCB D-type

CB	MC	OLR	kA@600V	Maximum HP	Maximum NEC FLC [A]	CB	MC	OLR	kA@600V	Maximum HP	Maximum NEC FLC [A]
UTS150L MCP	MC-6a	MT-12 0.1~10A	25	7.5	9	UTS150H MCP	MC-130a	MT-150 65~185A	25	75	77
UTS150L MCP	MC-9a	MT-12 0.1~10A	25	7.5	9	UTS150L MCP	MC-130a	MT-150 65~185A	50	75	77
UTS150L MCP	MC-12a	MT-12 0.1~13A	25	10	11	UTS150H MCP	MC-150a	MT-150 65~185A	25	75	77
UTS150L MCP	MC-18a	MT-12 0.1~18A	25	15	17	UTS150L MCP	MC-150a	MT-150 65~185A	50	75	77
UTS150L MCP	MC-9b	MT-32 0.1~10A	25	7.5	9	UTS250H MCP	MC-185a	MT-225 65~185A	25	125	125
UTS150L MCP	MC-12b	MT-32 0.1~13A	25	10	11	UTS250L MCP	MC-185a	MT-225 65~185A	50	125	125
UTS150L MCP	MC-18b	MT-32 0.1~18A	25	15	17	UTS400H MCP	MC-185a	MT-225 65~185A	25	125	125
UTS150L MCP	MC-22b	MT-32 0.1~25A	25	20	22	UTS400L MCP	MC-185a	MT-225 65~185A	50	125	125
UTS150L MCP	MC-32a	MT-32 0.1~32A	25	25	27	UTS250H MCP	MC-225a	MT-225 65~185A	25	150	144
UTS150L MCP	MC-40a	MT-32 0.1~32A	25	25	32	UTS250L MCP	MC-225a	MT-225 65~185A	50	150	144
UTS150H MCP	MC-50a	MT-63 4~65A	25	50	52	UTS400H MCP	MC-225a	MT-225 65~185A	25	150	144
UTS150L MCP	MC-50a	MT-63 4~65A	50	50	62	UTS400L MCP	MC-225a	MT-225 65~185A	50	150	144
UTS150H MCP	MC-65a	MT-63 4~65A	25	60	62	UTS400H MCP	MC-265a	MT-400 85~240A	25	200	192
UTS150L MCP	MC-65a	MT-63 4~65A	50	60	62	UTS400L MCP	MC-265a	MT-400 85~240A	50	200	192
UTS150H MCP	MC-75a	MT-95 7~75A	25	60	77	UTS400H MCP	MC-330a	MT-400 85~330A	25	200	242
UTS150L MCP	MC-75a	MT-95 7~75A	50	60	77	UTS400L MCP	MC-330a	MT-400 85~330A	50	200	242
UTS150H MCP	MC-85a	MT-95 7~85A	25	75	77	UTS600H MCP	MC-400a	MT-400 85~400A	25	300	289
UTS150L MCP	MC-85a	MT-95 7~85A	50	75	77	UTS600L MCP	MC-400a	MT-400 85~400A	50	300	289
UTS150H MCP	MC-100a	MT-95 7~85A	25	75	77	UTS800L MCP	MC-500a	MT-800 200~400A	50	400	382
UTS150L MCP	MC-100a	MT-95 7~85A	50	75	77	UTS800L MCP	MC-630a	MT-800 200~600A	50	500	472

Rated UL 508 combination motor controller type-F

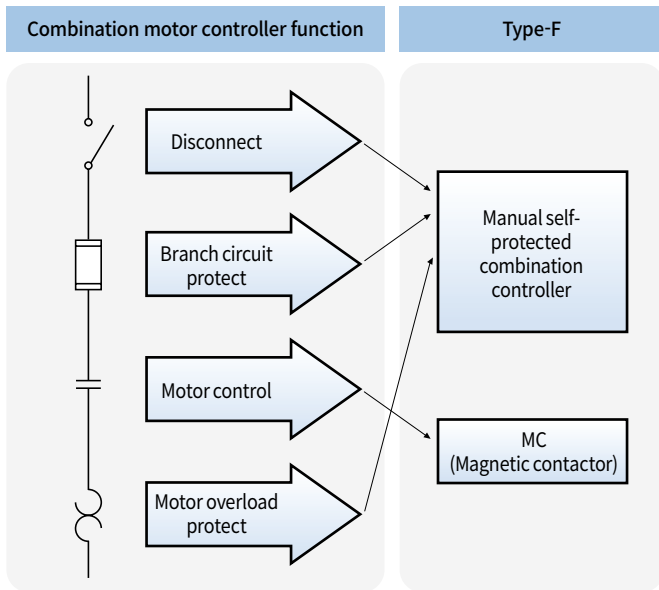

32AF rotary operation, High interruption

Manual self-Protected	Adjustment range (A)	Short circuit rating (kA)			MC (Applied contactor)	
		240V	480Y/277V	600Y/347V	Susol	Metasol
MMS-32H-0.16	0.1~0.16	100	65	25	MC-9	MC-6a/MC-9a/MC-9b
MMS-32H-0.25	0.16~0.25	100	65	25	MC-9	MC-6a/MC-9a/MC-9b
MMS-32H-0.4	0.25~0.4	100	65	25	MC-9	MC-6a/MC-9a/MC-9b
MMS-32H-0.63	0.4~0.63	100	65	25	MC-9	MC-6a/MC-9a/MC-9b
MMS-32H-1	0.63~1	100	65	25	MC-9	MC-6a/MC-9a/MC-9b
MMS-32H-1.6	1~1.6	100	65	25	MC-9	MC-6a/MC-9a/MC-9b
MMS-32H-2.5	1.6~2.5	100	65	25	MC-12	MC-12a/MC-12b
MMS-32H-4	2.5~4	100	65	25	MC-12	MC-12a/MC-12b
MMS-32H-6	4~6	100	65	25	MC-18	MC-18a/MC-18b
MMS-32H-8	5~8	100	65	10	MC-18	MC-18a/MC-18b
MMS-32H-10	6~10	100	65	10	MC-18	MC-18a/MC-18b
MMS-32H-13	9~13	100	65	10	MC-25	MC-22b/MC-25a
MMS-32H-17	11~17	100	30	10	MC-25	MC-22b/MC-25a
MMS-32H-22	14~22	100	30	10	MC-25	MC-22b/MC-25a
MMS-32H-26	18~26	100	30	10	MC-32	MC-32a
MMS-32H-32	22~32	100	30	10	MC-32	MC-32a
MMS-32H-40	28~40	100	30	10	-	MC-35a/MC-40a

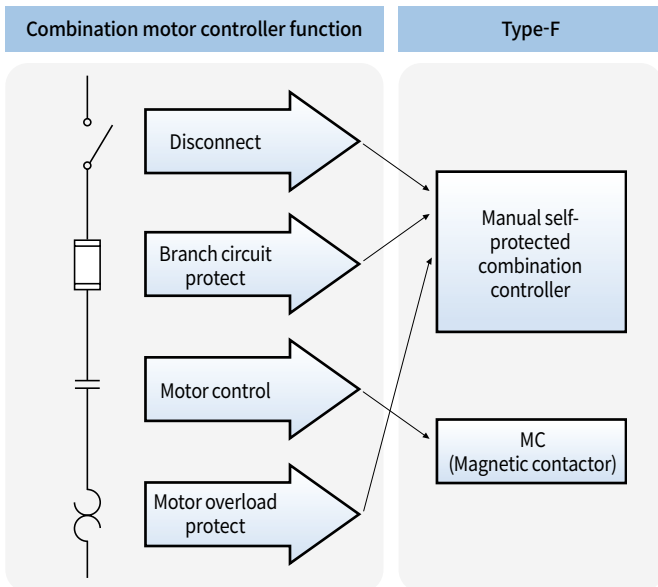

63AF rotary operation, Standard interruption

Manual self-Protected	Adjustment range (A)	Short circuit rating (kA)			MC (Applied contactor)	
		240V	480Y/277V	600Y/347V	Susol	Metasol
MMS-63S-10	6~10	100	50	10	MC-35	MC-50a
MMS-63S-13	9~13	100	50	10	MC-35	MC-50a
MMS-63S-17	11~17	100	40	10	MC-35	MC-50a
MMS-63S-22	14~22	100	40	10	MC-35	MC-50a
MMS-63S-26	18~26	100	40	10	MC-35	MC-50a
MMS-63S-32	22~32	100	40	10	MC-35	MC-50a
MMS-63S-40	28~40	100	40	10	MC-40	MC-50a
MMS-63S-50	34~50	100	40	10	MC-50	MC-50a
MMS-63S-63	45~63	100	40	10	MC-63	MC-65a
MMS-63S-65	47~65	100	40	10	-	MC-65a

63AF rotary operation, High interruption

Manual self-Protected	Adjustment range (A)	Short circuit rating (kA)			MC (Applied contactor)	
		240V	480Y/277V	600Y/347V	Susol	Metasol
MMS-63H-10	6~10	100	65	25	MC-35	MC-50a
MMS-63H-13	9~13	100	65	25	MC-35	MC-50a
MMS-63H-17	11~17	100	50	10	MC-35	MC-50a
MMS-63H-22	14~22	100	50	10	MC-35	MC-50a
MMS-63H-26	18~26	100	50	10	MC-35	MC-50a
MMS-63H-32	22~32	100	50	10	MC-35	MC-50a
MMS-63H-40	28~40	100	50	10	MC-40	MC-50a
MMS-63H-50	34~50	100	50	10	MC-50	MC-50a
MMS-63H-63	45~63	100	50	10	MC-63	MC-65a
MMS-63H-65	47~65	100	40	10	-	MC-65a

Rated UL 508 combination motor controller type-F

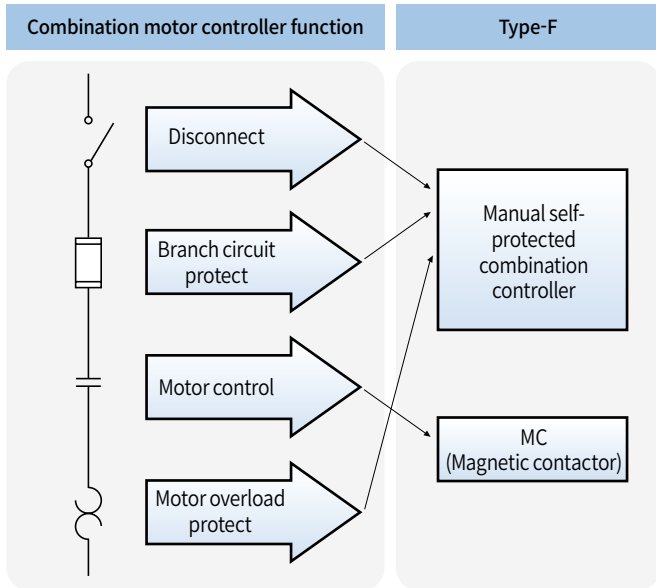

100AF rotary operation, Standard interruption

Manual self-Protected	Adjustment range (A)	Short circuit rating (kA)			MC (Applied contactor)	
		240V	480Y/277V	600Y/347V	Susol	Metasol
MMS-100S-17	11~17	100	50	10	MC-65	MC-75a
MMS-100S-22	14~22	100	50	10	MC-65	MC-75a
MMS-100S-26	18~26	100	50	10	MC-65	MC-75a
MMS-100S-32	22~32	100	50	10	MC-65	MC-75a
MMS-100S-40	28~40	100	50	10	MC-65	MC-75a
MMS-100S-50	34~50	100	50	10	MC-65	MC-75a
MMS-100S-63	45~63	100	40	10	MC-65	MC-75a
MMS-100S-75	55~75	100	40	10	MC-75	MC-75a
MMS-100S-90	70~90	100	40	10	MC-85	MC-85a
MMS-100S-100	80~100	100	40	10	MC-95	MC-100a

100AF rotary operation, High interruption

Manual self-Protected	Adjustment range (A)	Short circuit rating (kA)			MC (Applied contactor)	
		240V	480Y/277V	600Y/347V	Susol	Metasol
MMS-100H-17	11~17	100	65	25	MC-65	MC-75a
MMS-100H-22	14~22	100	65	20	MC-65	MC-75a
MMS-100H-26	18~26	100	65	20	MC-65	MC-75a
MMS-100H-32	22~32	100	65	20	MC-65	MC-75a
MMS-100H-40	28~40	100	65	20	MC-65	MC-75a
MMS-100H-50	34~50	100	65	20	MC-65	MC-75a
MMS-100H-63	45~63	100	50	10	MC-65	MC-75a
MMS-100H-75	55~75	100	50	10	MC-75	MC-75a
MMS-100H-90	70~90	100	50	10	MC-85	MC-85a
MMS-100H-100	80~100	100	50	10	MC-95	MC-100a

LS contactor ready for IE3-rated motors



What is the IE3?

Motor is rated from IE1 through IE4 depends on its energy efficiency which means IE3 is more efficient compared to IE1 and IE2-rated motors. IE3-rated motor is not only more efficient than IE2-rated motor but it also has lower rated current and higher starting current & inrush current.



WHY IE3?

As part of the EU Environmental policy "20/30-20-20" strategy, the EU is committed to achieve the followings by 2020

- Reduce greenhouse gas emissions by up to 30 %
- Increase the share of renewable energy to 20 % and
- Boost energy efficiency by 20% in general. IEC 60034-30 standard specifies IE classes for motors in accordance with the above requirements.
- IEC 60034-30-1 standard
 - IE1 Standard Efficiency
 - IE2 High Efficiency
 - **IE3 Premium Efficiency**
 - IE4 Super Premium Efficiency



IE3 motors can be associated with standard starter solutions, like contactor, manual motor starter.

During the starting the IE3 motor, Inrush and starting current are increased compared with IE2 motor.

The increased inrush and starting current can affect the selection of the electrical device.

In order to secure the highest efficiency in your electrical system, it is strongly recommended to use the more efficient IE3 class product.

LS contactors are already compliant with IE3.

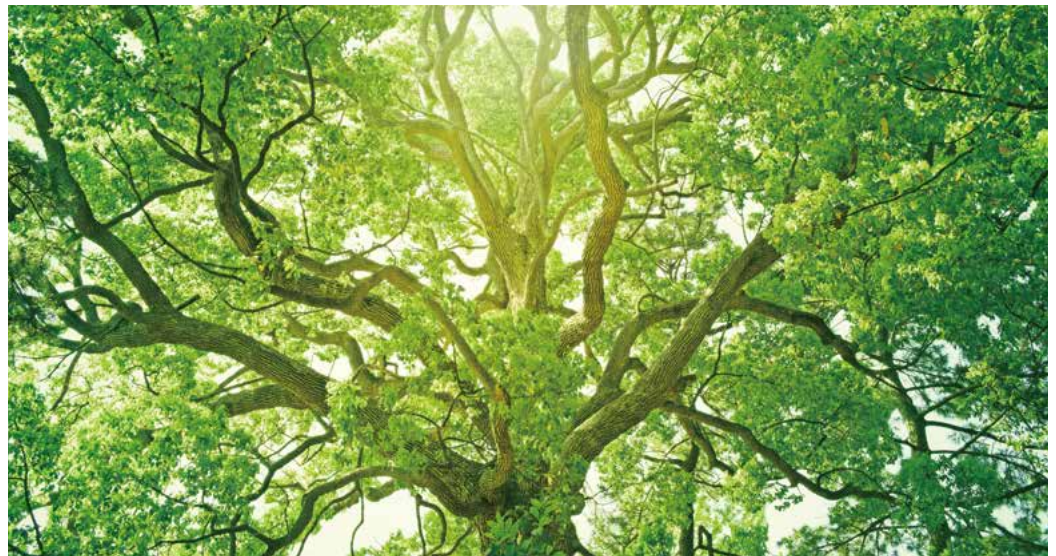

Dimension

3-pole contactors 18AF/22AF

[mm]

MC-6a~18a AC

1NO or 1NC

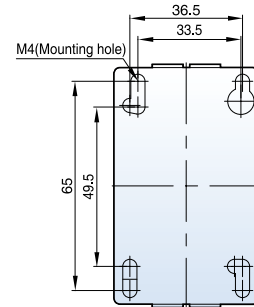
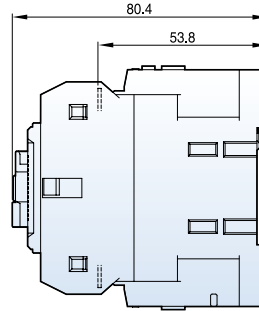
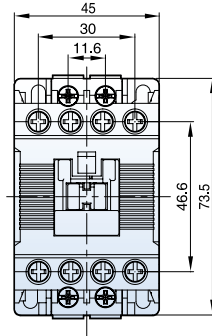

0.3kg

MC-6a~18a DC

1NO or 1NC

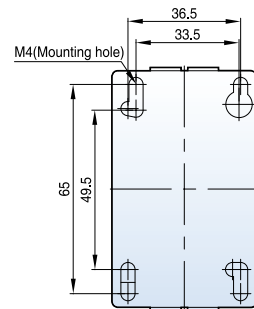
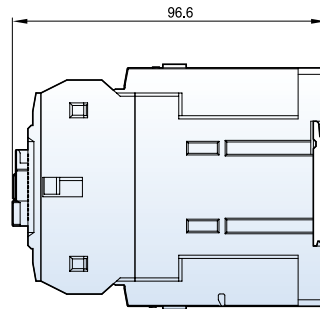
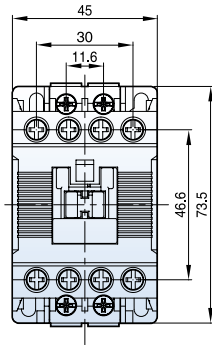

0.4kg

MC-9b~22b AC

1NO1NC

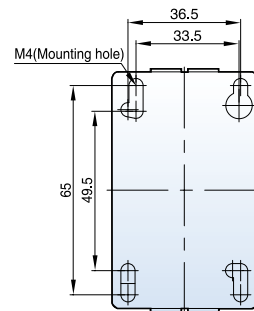
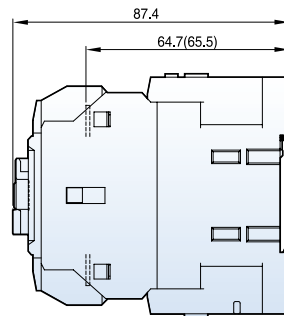
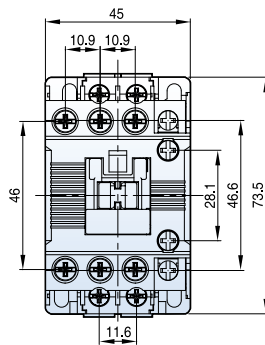

* () MC-18b, 22b

0.3kg

MC-9b~22b DC

1NO1NC

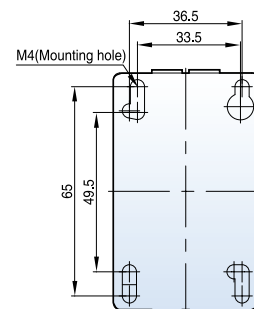
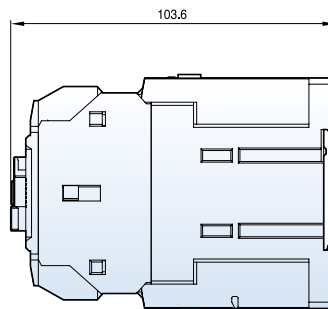
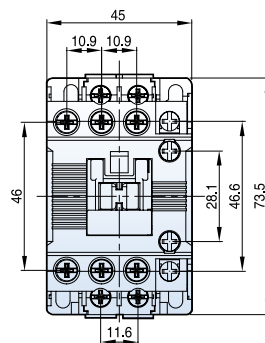

0.41kg

3-pole contactors 40AF

[mm]

MC-32a~40a AC

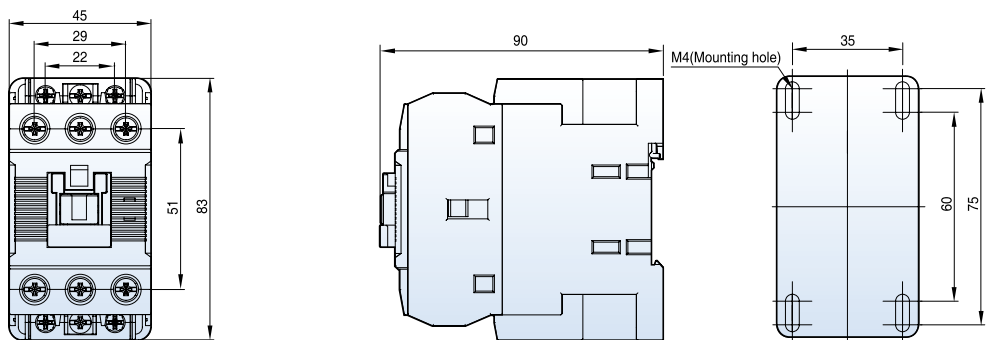

0.4kg

MC-32a~40a DC

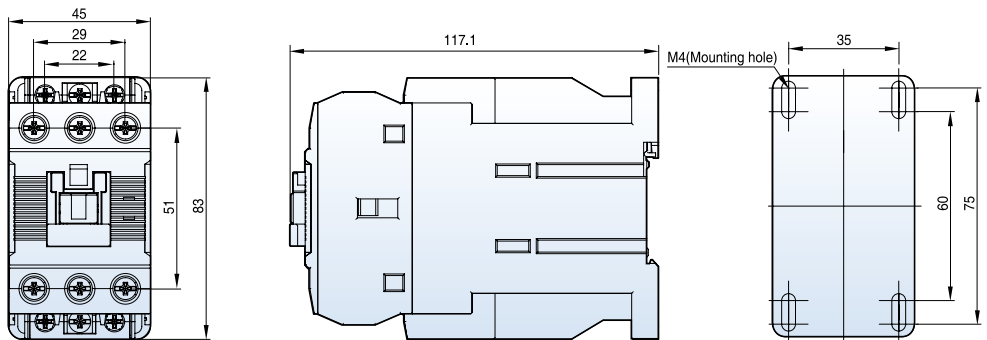

0.6kg

MC-32a~40a AC

2NO2NC

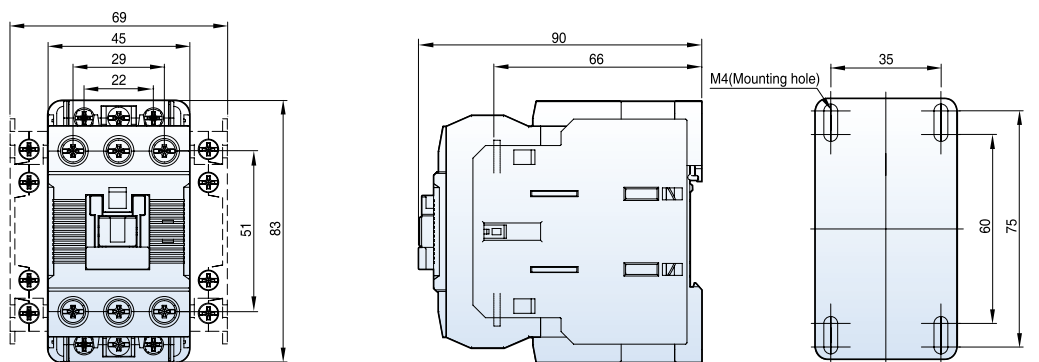

0.5kg

MC-32a~40a DC

2NO2NC

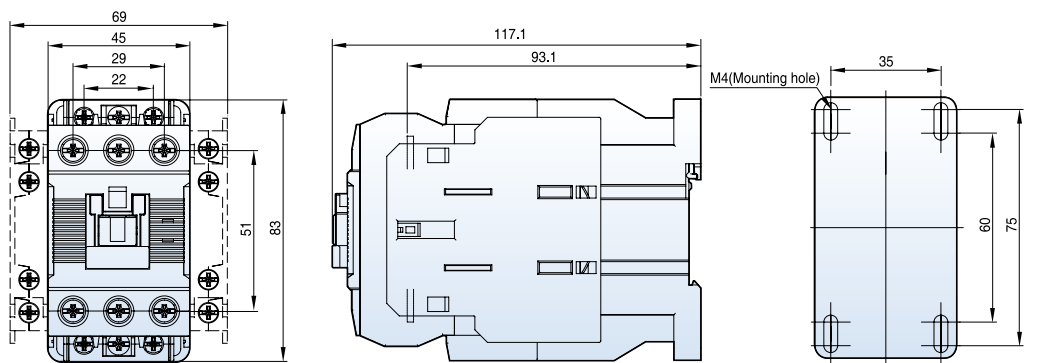

0.8kg

Dimension

3-pole contactors 65AF

[mm]

MC-50a~65a AC

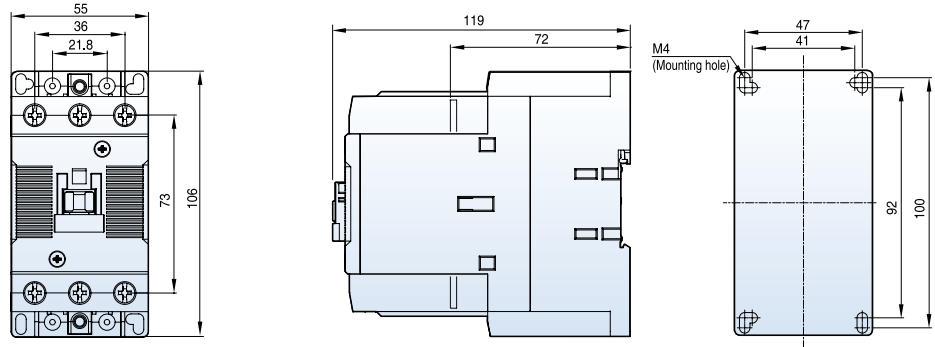

0.9kg

MC-50a~65a DC

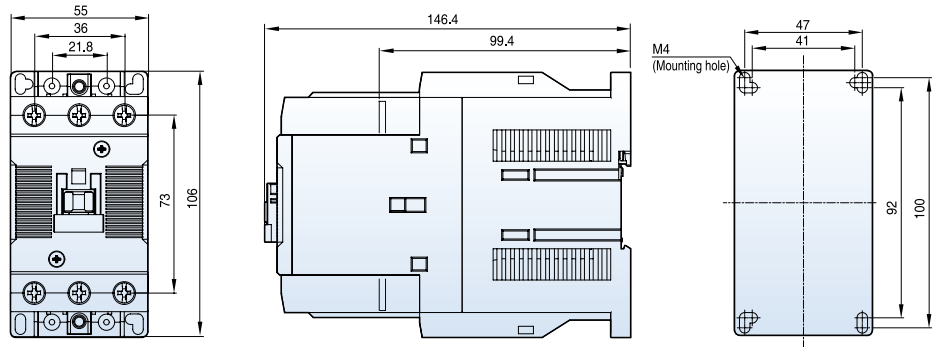

1.2kg

MC-50a~65a AC

2NO2NC

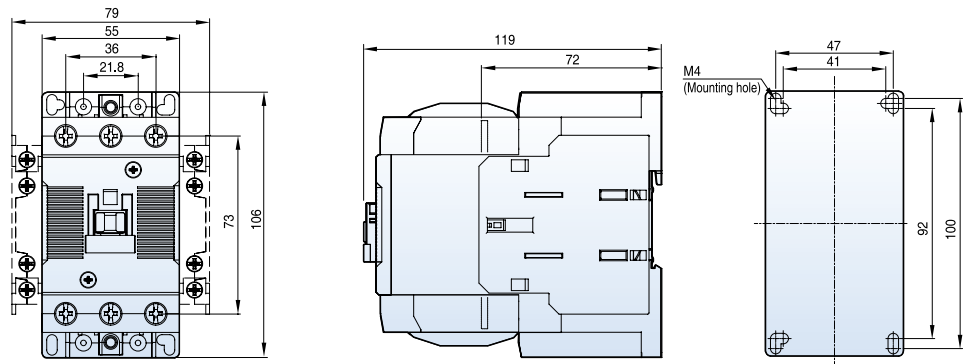

1kg

MC-50a~65a DC

2NO2NC

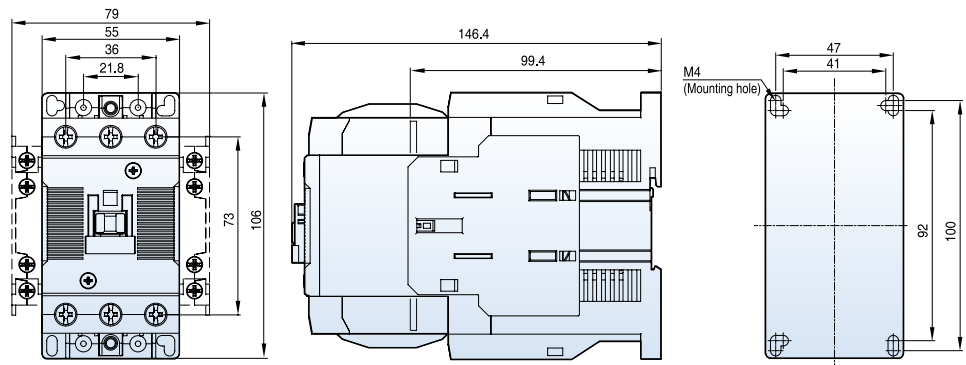

1.3kg

3-pole contactors 100AF

[mm]

MC-75a~100a AC

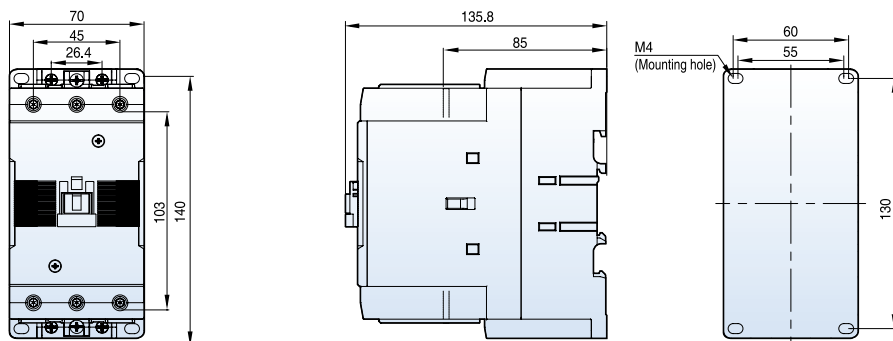

1.8kg

MC-75a~100a DC

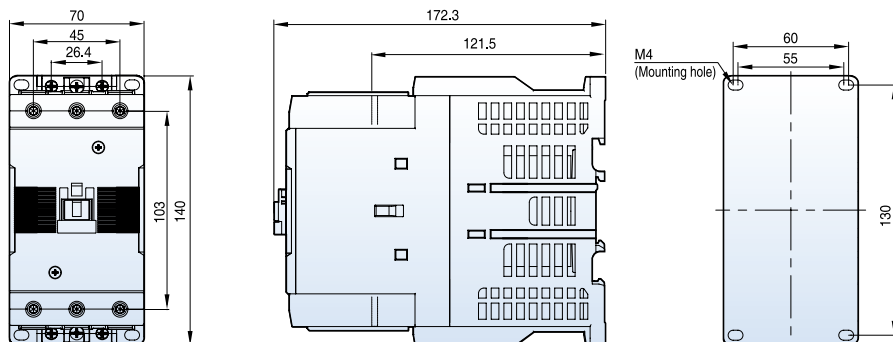

2.7kg

MC-75a~100a AC

2NO2NC

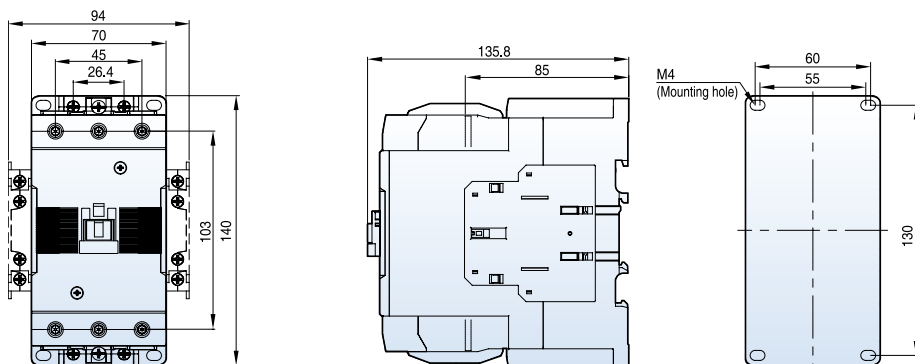

1.9kg

MC-75a~100a DC

2NO2NC

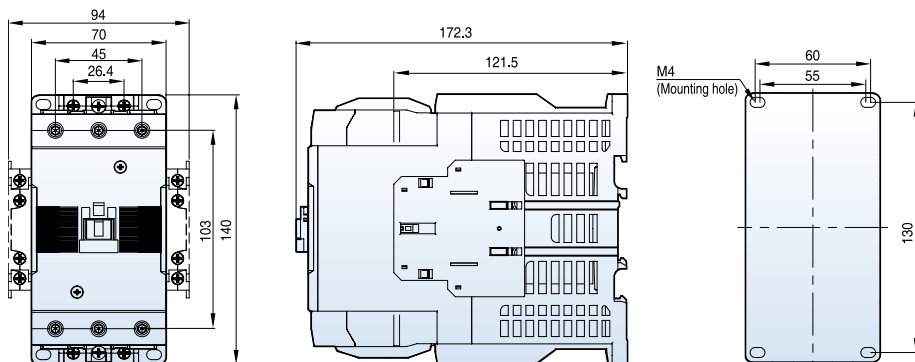

2.8kg

Dimension

3-pole contactors 150AF~400AF

[mm]

MC-130a

MC-150a

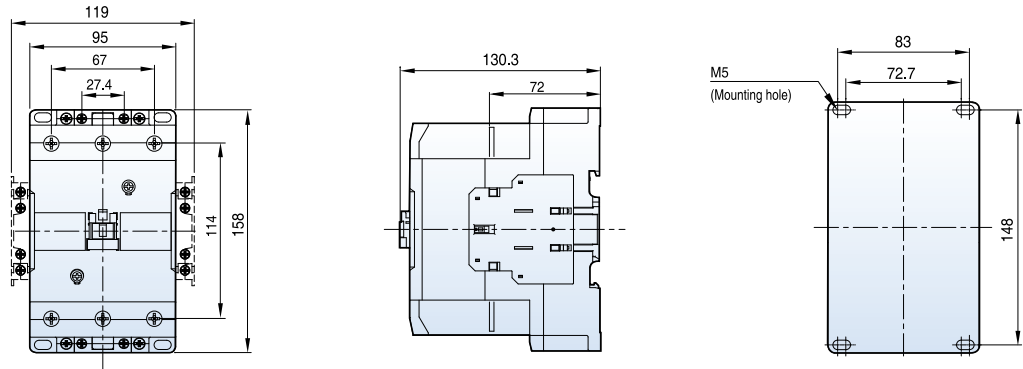

2.4kg

MC-185a

MC-225a

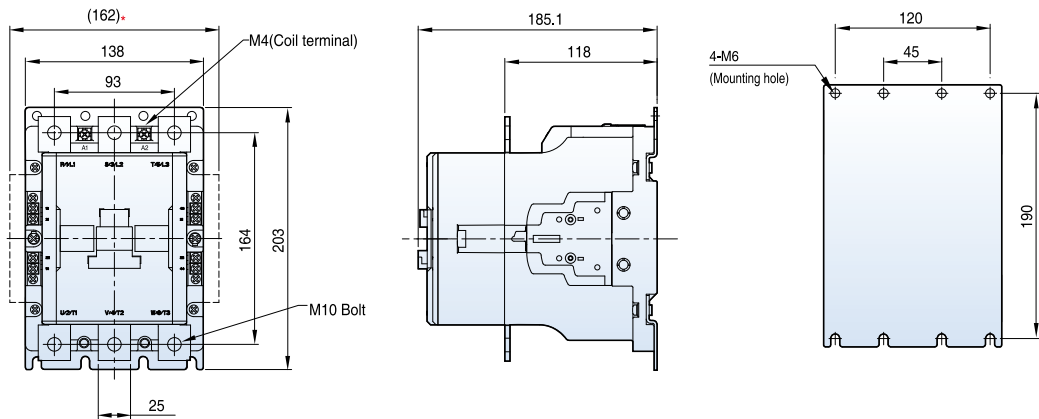

5.4kg

MC-265a

MC-330a

MC-400a

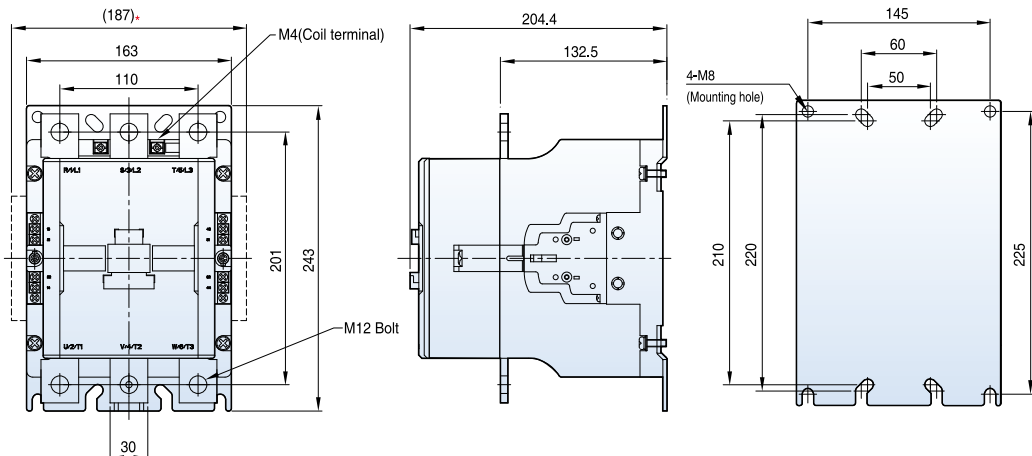

* Optional auxiliary contact unit (side mount type)

9.2kg

3-pole contactors 800AF~2650AF

[mm]

- MC-500a
- MC-630a
- MC-800a
- MCI-900
- MCI-1050

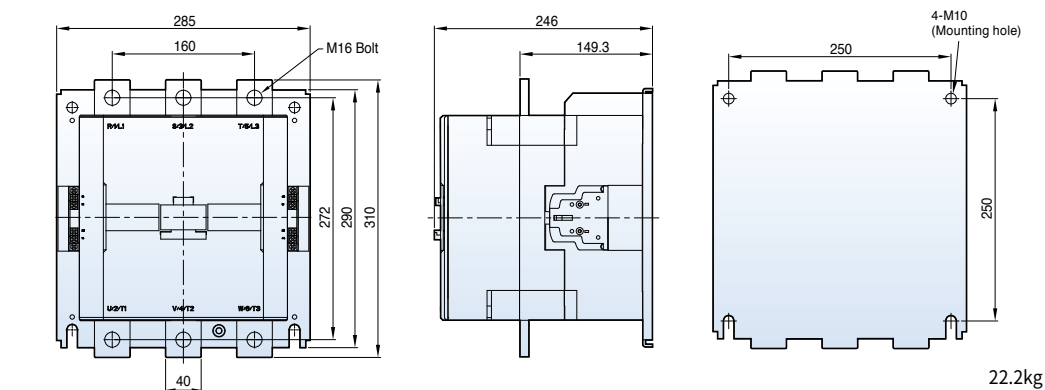

- MC-1260a
- MCI-1260

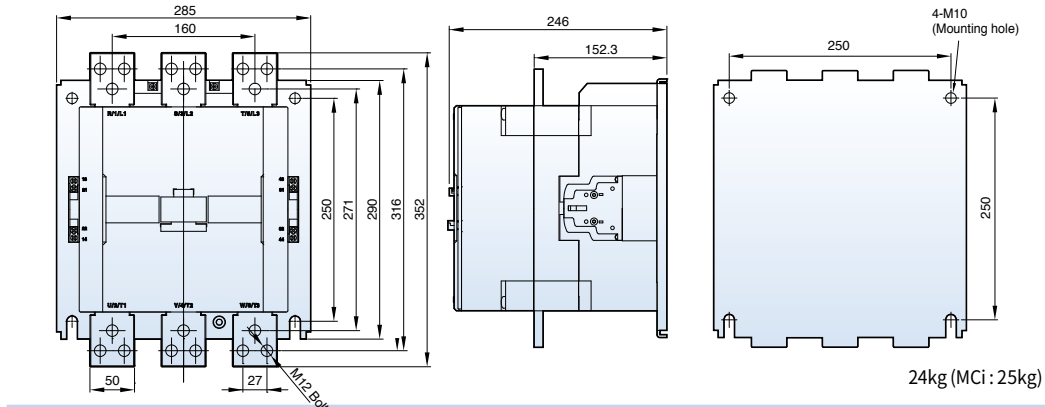

- MC-1400a
- MC-1700a
- MC-2100a
- MCI-1700
- MCI-2100

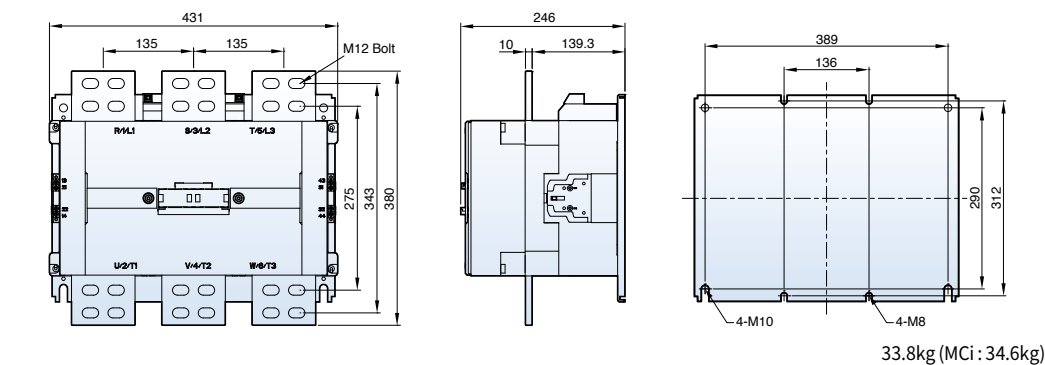

- MC-2650a
- MCI-2650

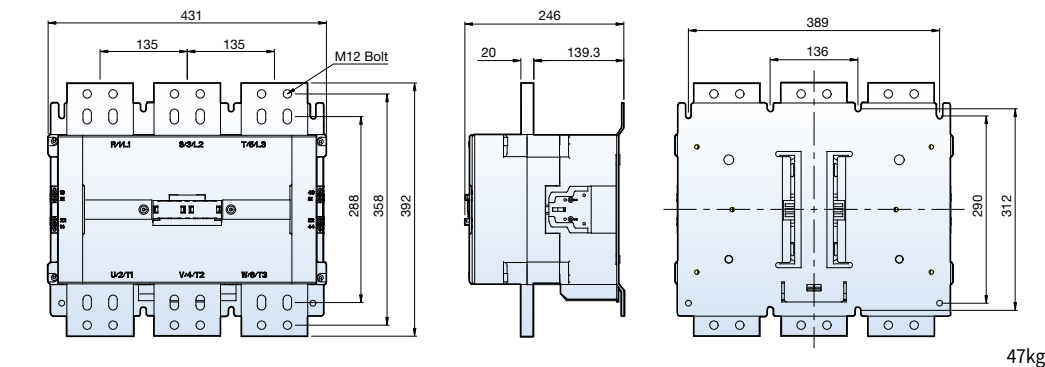

Dimension

Motor starters 18AF~40AF

[mm]

MS-6a~18a

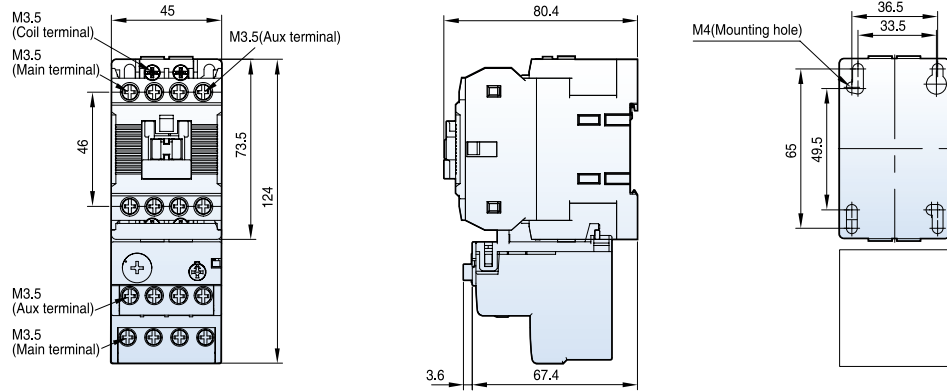

0.5kg

MS-9b~22b

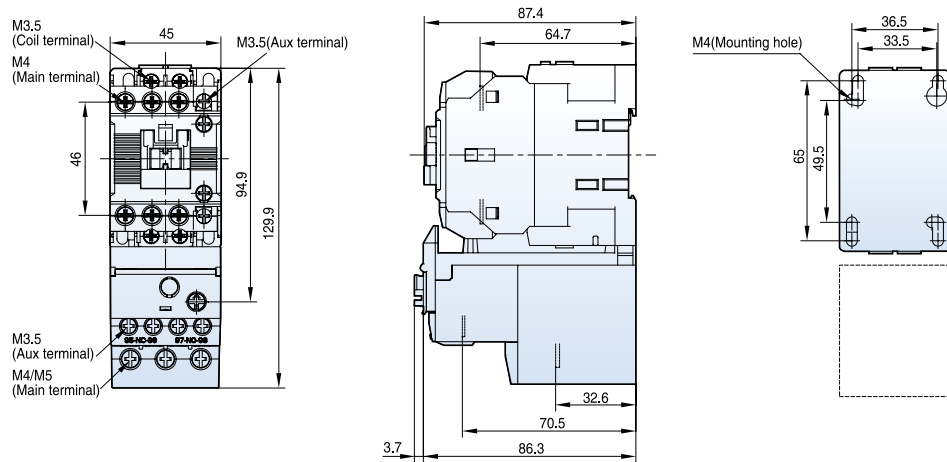

0.5kg

MS-32a~40a

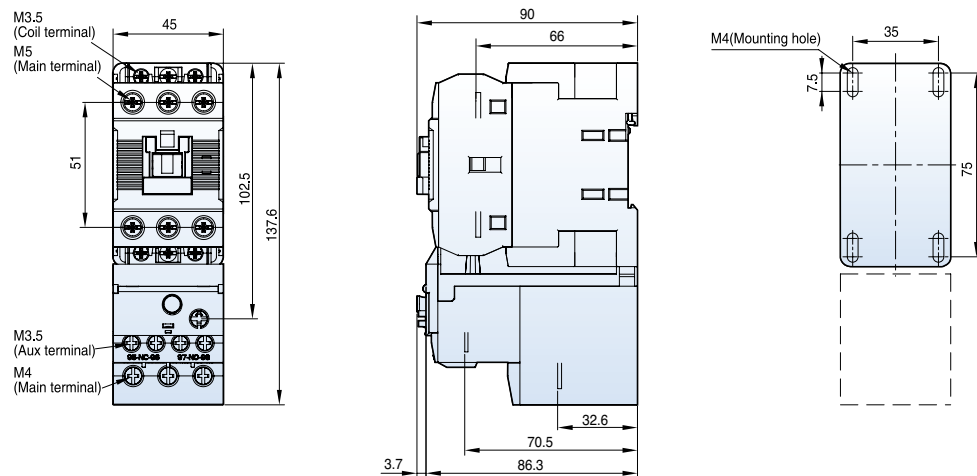

0.6kg

Motor starters 65AF~150AF

[mm]

MS-50a~65a

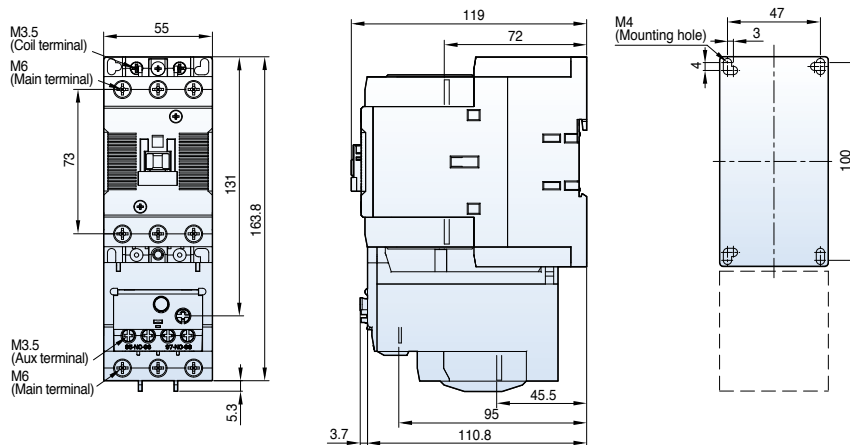

1.3kg

MS-75a~100a

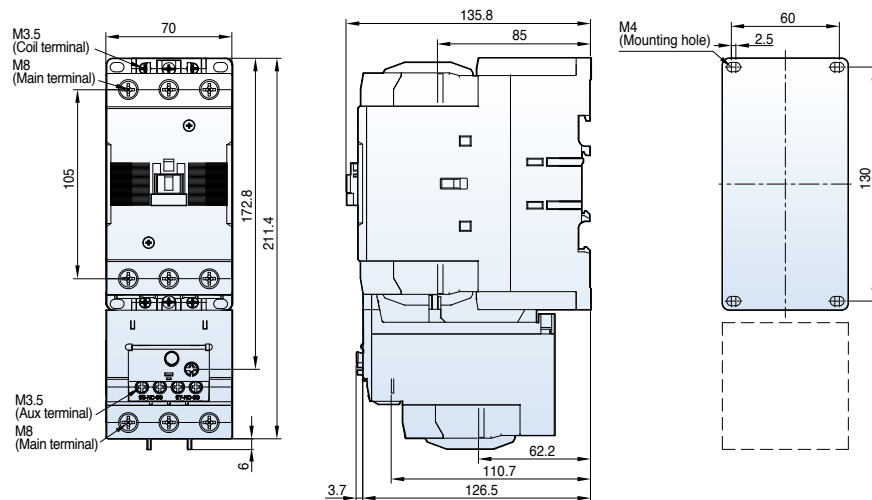

2.3kg

MS-130a

MS-150a

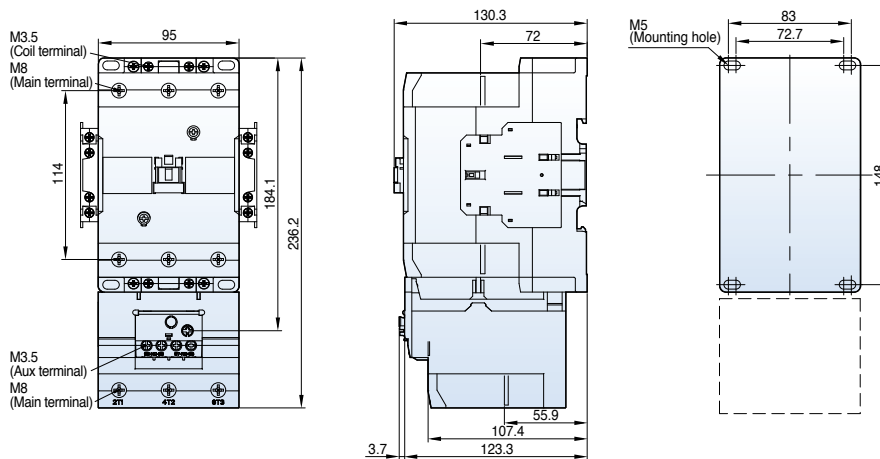

2.9kg

Dimension

Motor starters 185AF~800AF

[mm]

MS-185a

MS-225a

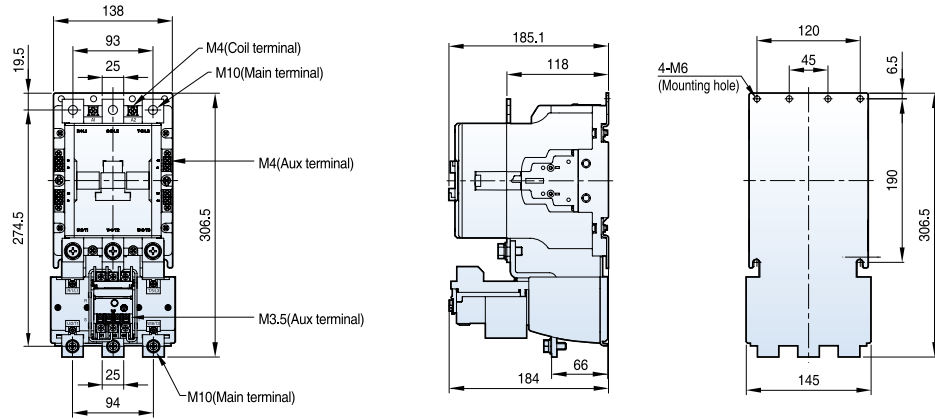

7.9kg

MS-265a

MS-330a

MS-400a

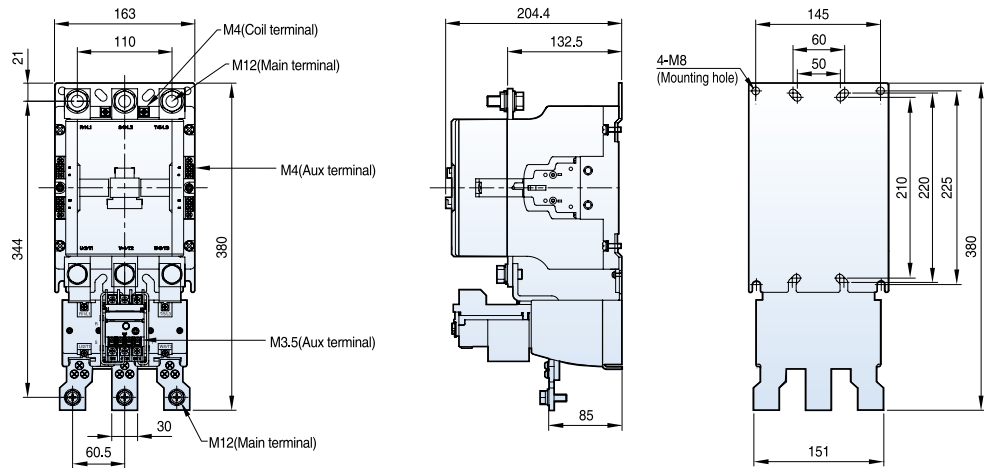

11.8kg

MS-500a

MS-630a

MS-800a

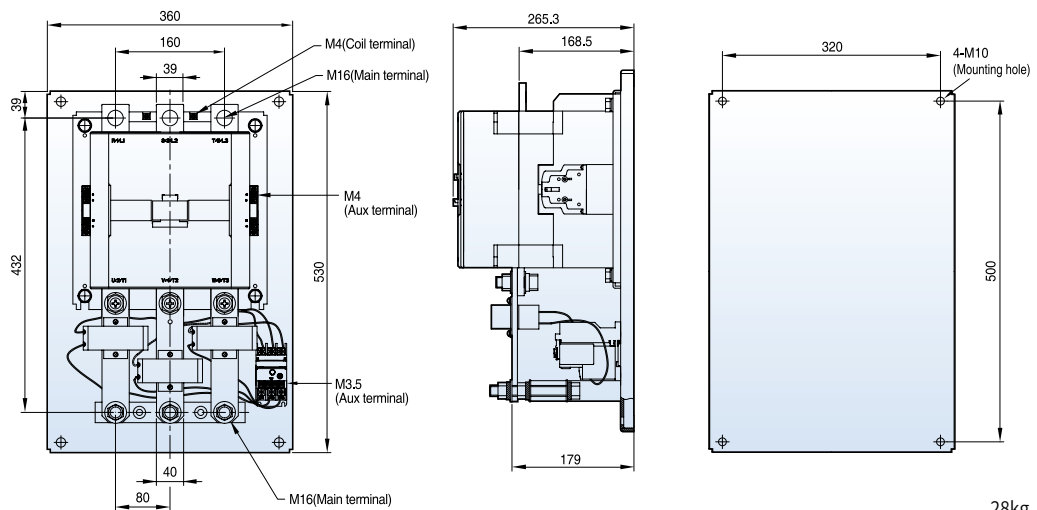

28kg

Reversing contactors and starters 18AF

[mm]

MC-6aR~18aR AC

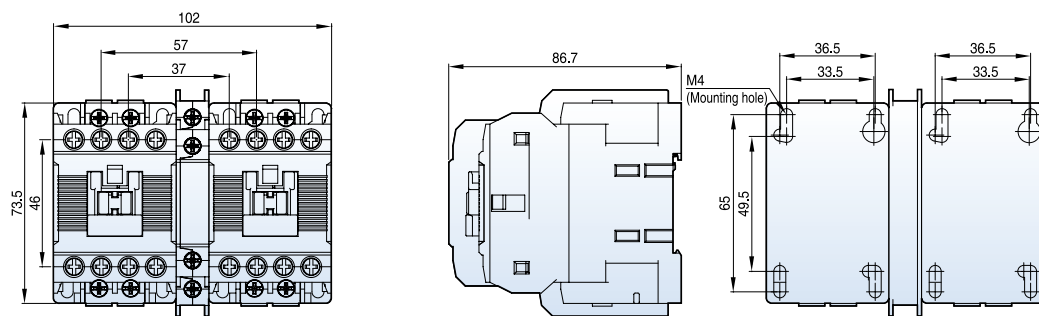

0.7kg

MC-6aR~18aR DC

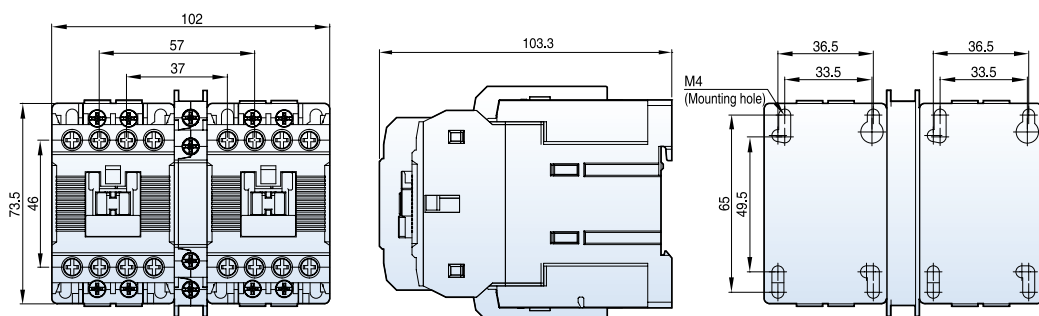

1kg

MS-6aR~18aR AC

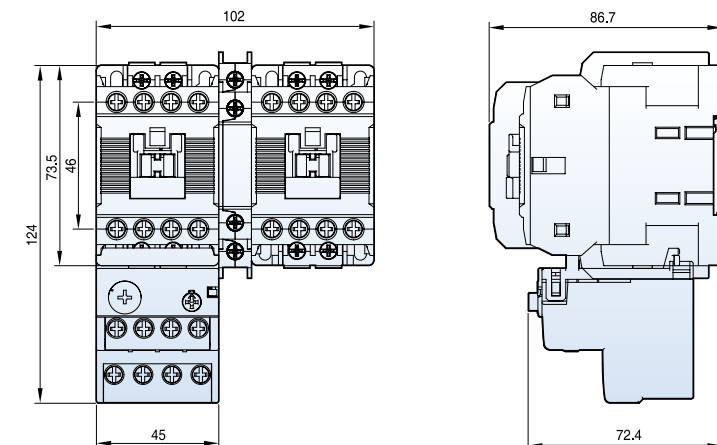

0.9kg

Dimension

Reversing contactors and starters 22AF

[mm]

MC-9bR-22bR AC

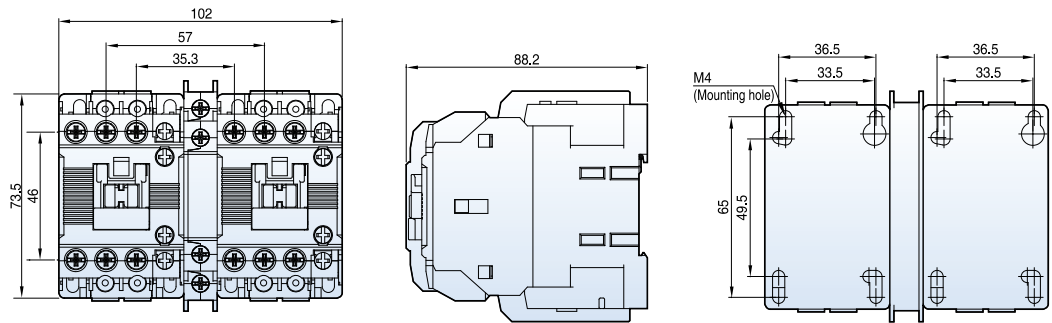

0.7kg

MC-9bR-22bR DC

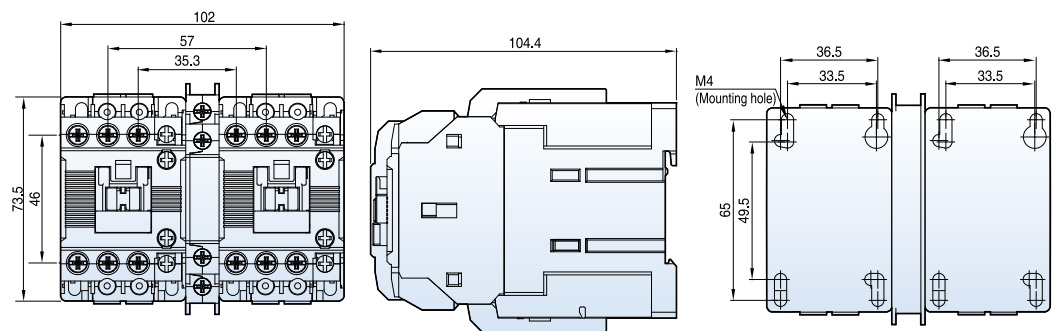

1.1kg

MS-9bR-22bR AC

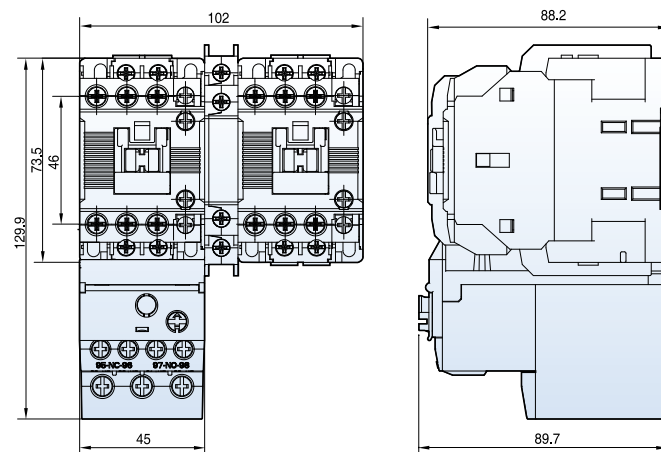

1.3kg

Reversing contactors and starters 40AF

[mm]

MC-32aR~40aR AC

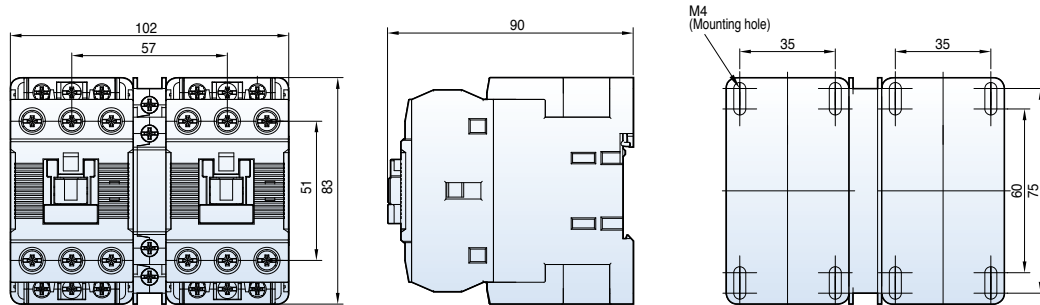

0.9kg

MC-32aR~40aR DC

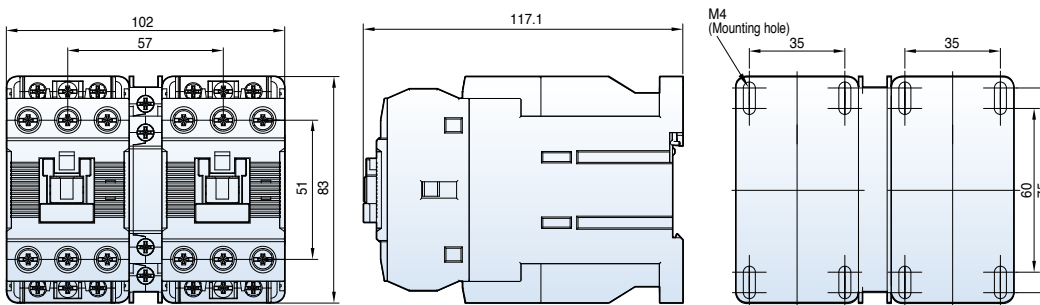

1.4kg

MS-32aR~40aR AC

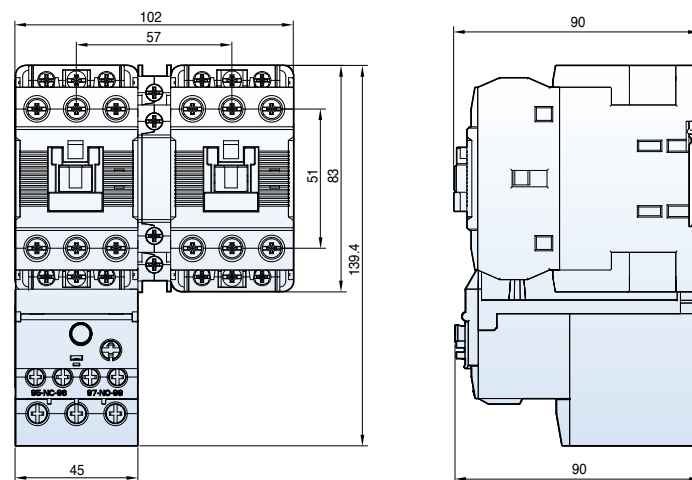

1.1kg

Dimension

Reversing contactors and starters 65AF

[mm]

MC-50aR~65aR AC

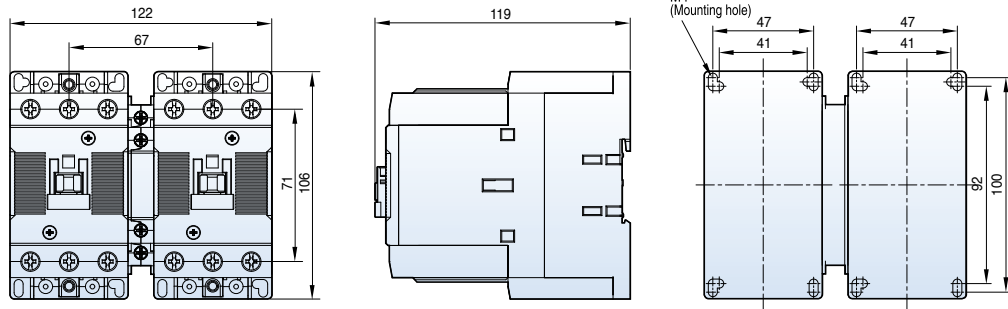

1.8kg

MC-50aR~65aR DC

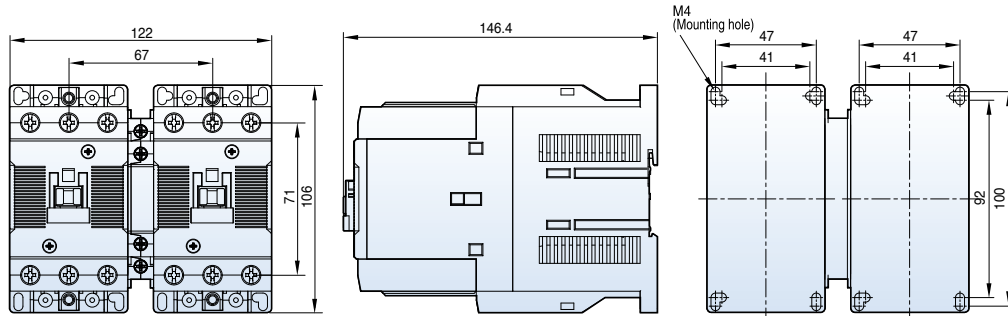

2.4kg

MS-50aR~65aR AC

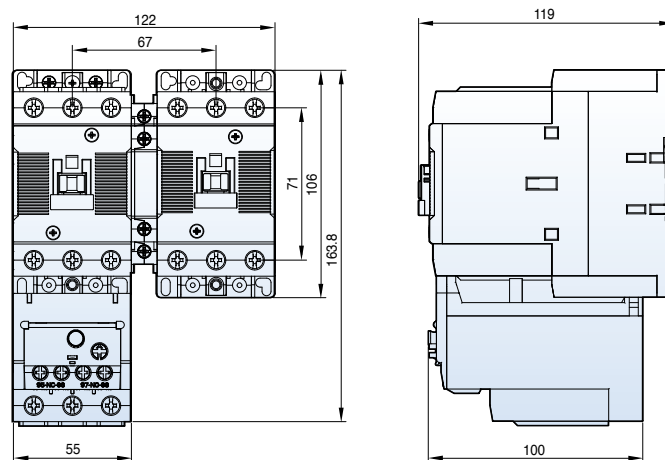

1.9kg

Reversing contactors and starters 100AF

[mm]

MC-75aR-100aR AC

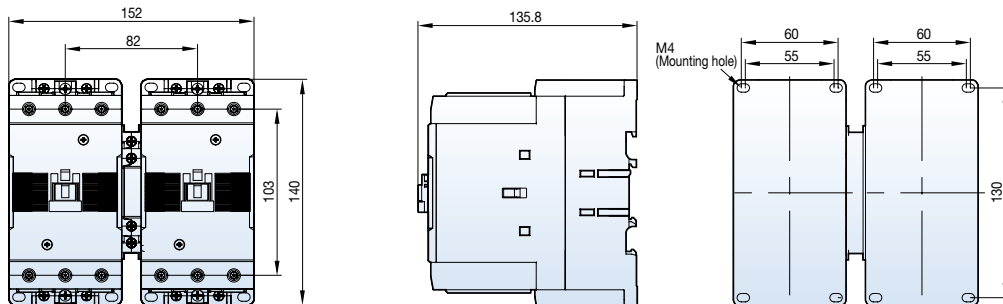

3.3kg

MC-75aR-100aR DC

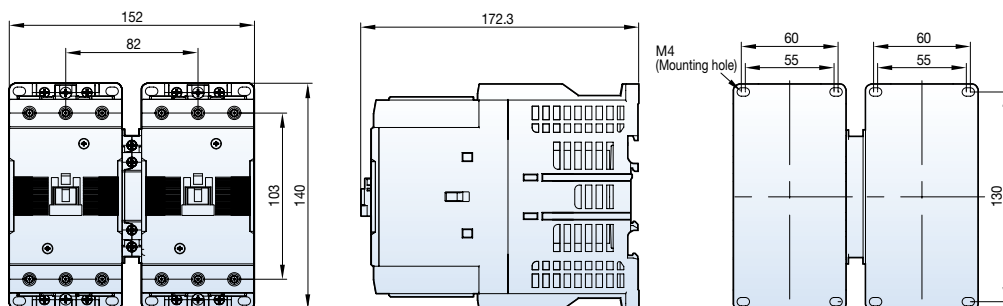

5.2kg

MS-75aR-100aR AC

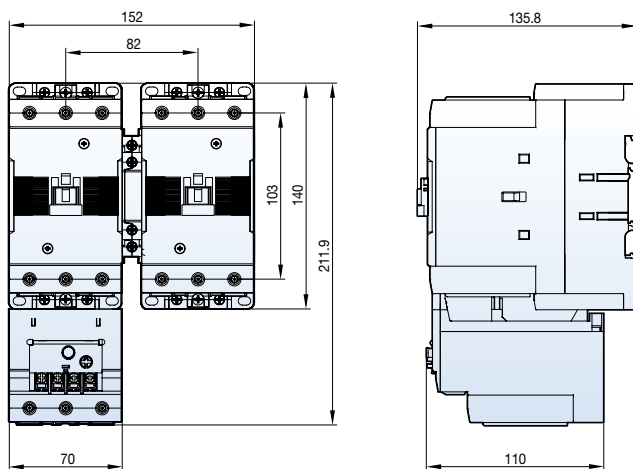

3.8kg

Dimension

Reversing contactors and starters 150~800AF

[mm]

MC-130aR

MC-150aR

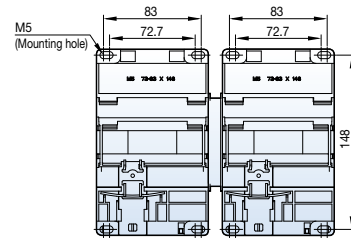
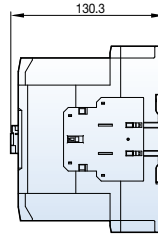
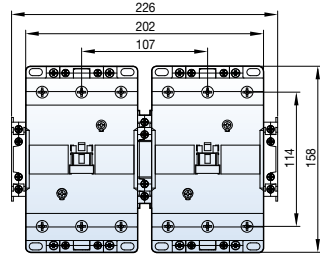

4.3kg

MC-185aR

MC-225aR

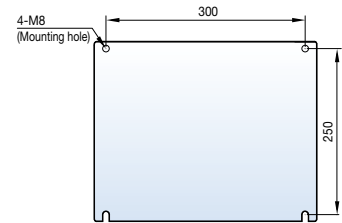
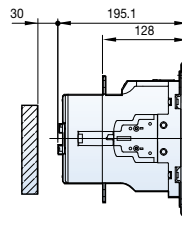
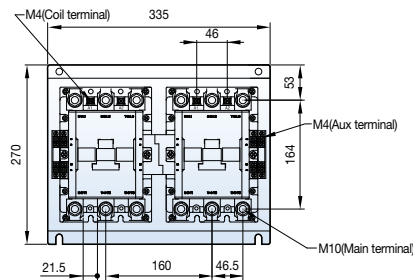

12.9kg

MC-265aR

MC-330aR

MC-400aR

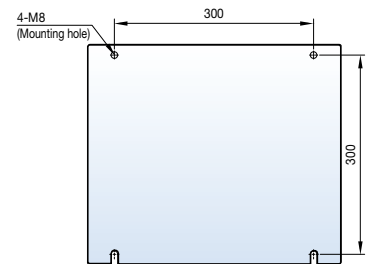
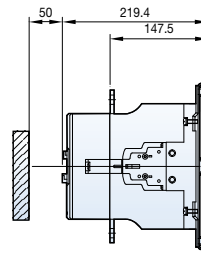
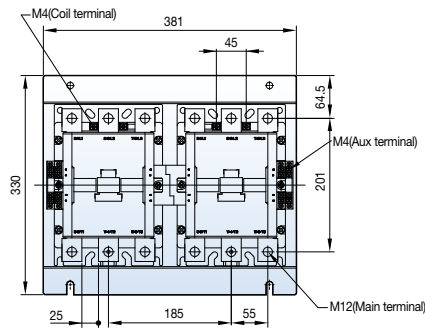

21.4kg

MC-500aR

MC-630aR

MC-800aR

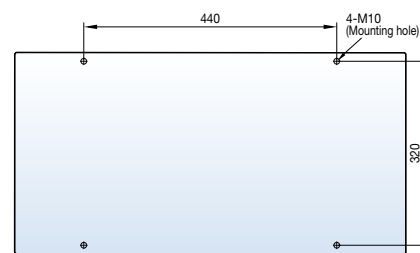
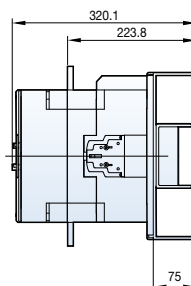
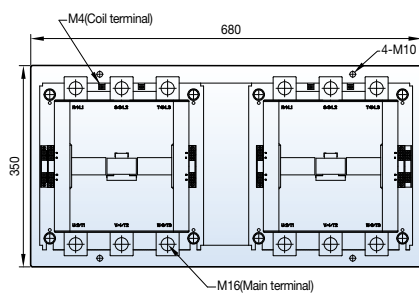

60kg

Reversing contactors and starters 150~400AF

[mm]

MS-130aR AC

MS-150aR AC

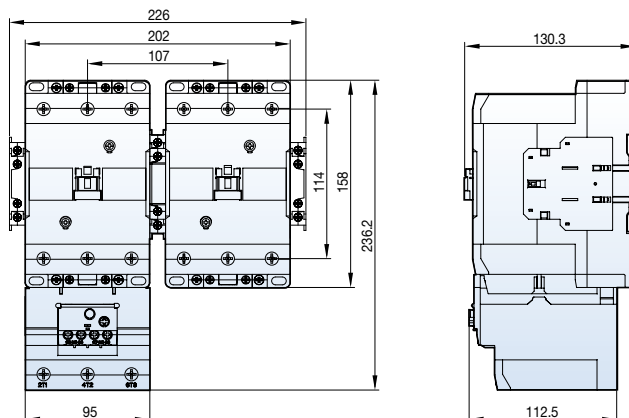

5kg

MS-185aR AC

MS-225aR AC

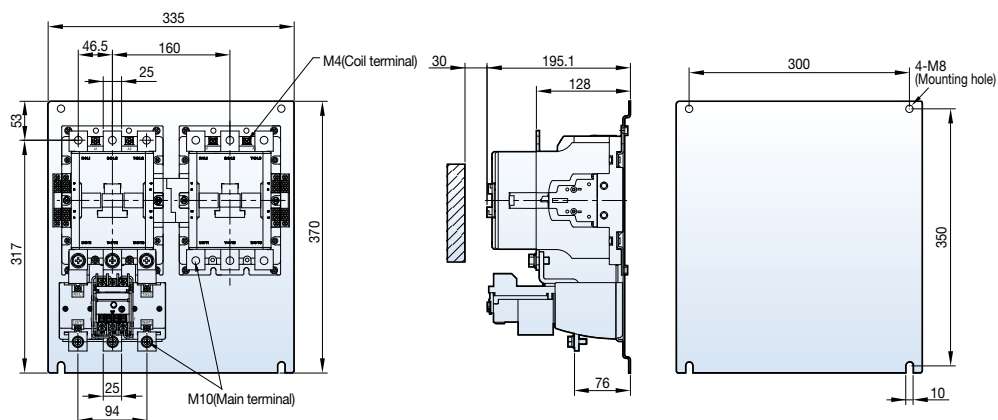

15.5kg

MS-265aR DC

MS-330aR DC

MS-400aR DC

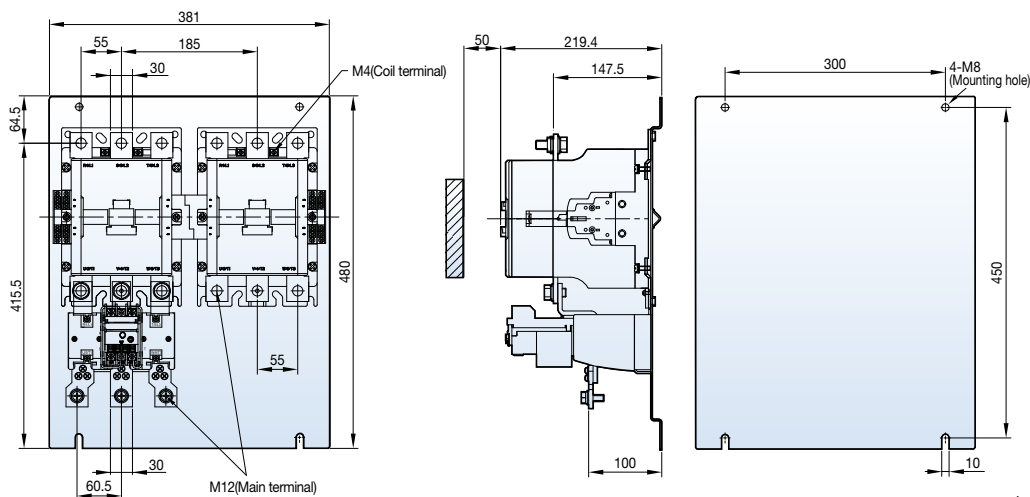

23kg

Dimension

Contactor relays

[mm]

MR-4 (D)

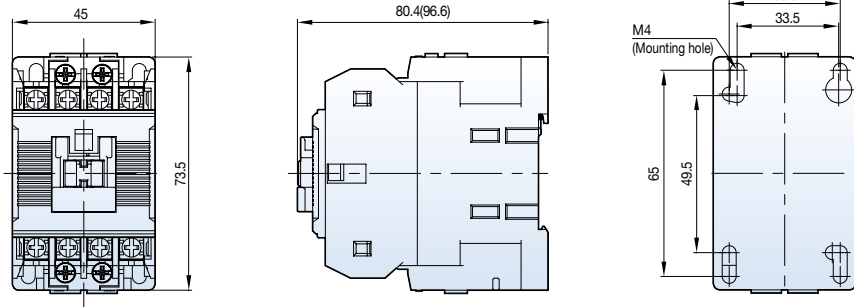

284g

MR-6 (D)

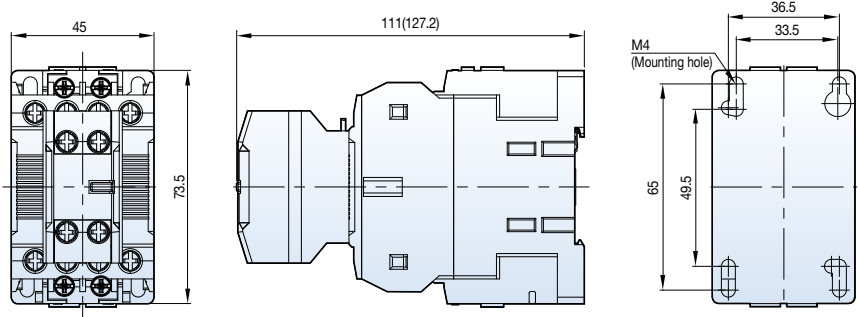

315g

MR-8 (D)

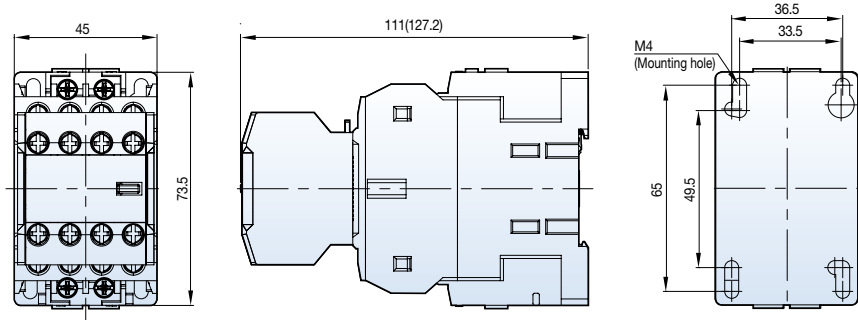

339g

Composition

MR-4	
MR-6	<p>Note1</p>
MR-8	<p>Note2</p>

Note) 1. UA-2: Auxiliary contact units 2. UA-4: Auxiliary contact units

- Please refer to the contact diagram represented on catalog when contactor relays MR-4, 4D and auxiliary contact units UA-2,4 are purchased separately.
- Be sure to order the auxiliary contact units separately except for the above contact units. • (): Dimension for DC control contactor relays

Latching contactors 18AF/22AF

[mm]

MC-6a-18a AC
1NO or 1NC + ML-65

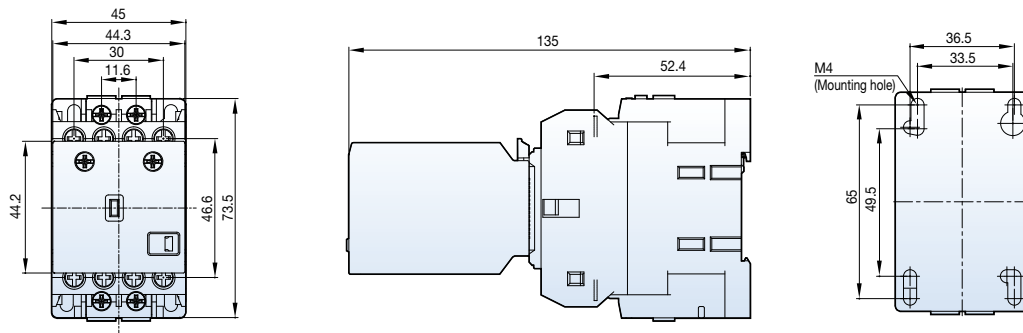

MC-6a-18a DC
1NO or 1NC + ML-65

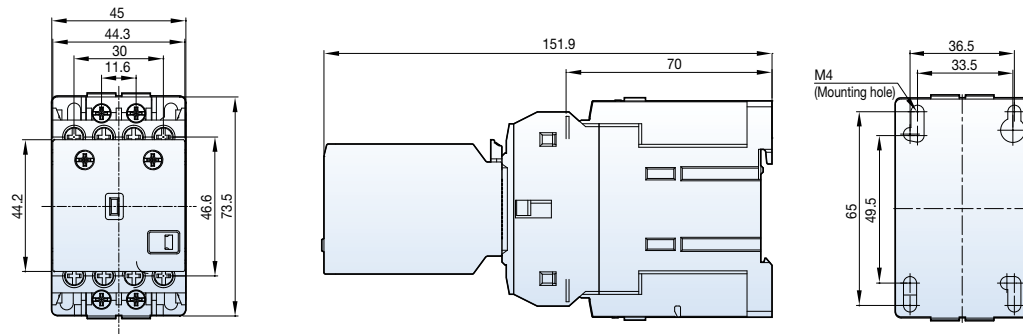

MC-9b-22b AC
1NO1NC + ML-65

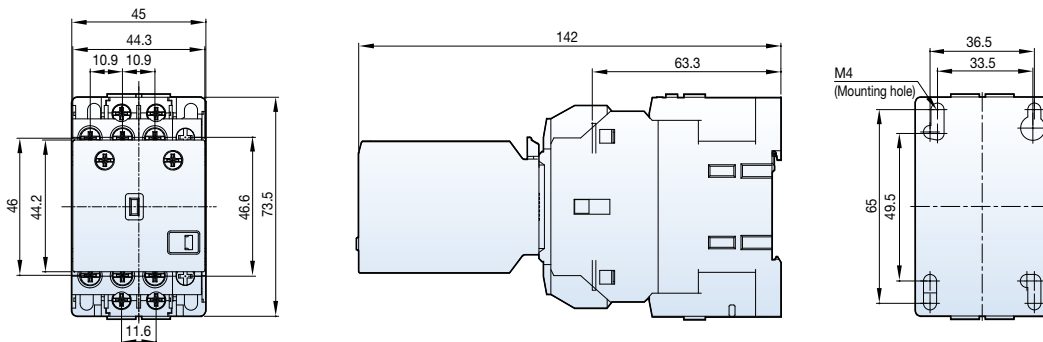

MC-9b-22b DC
1NO1NC + ML-65

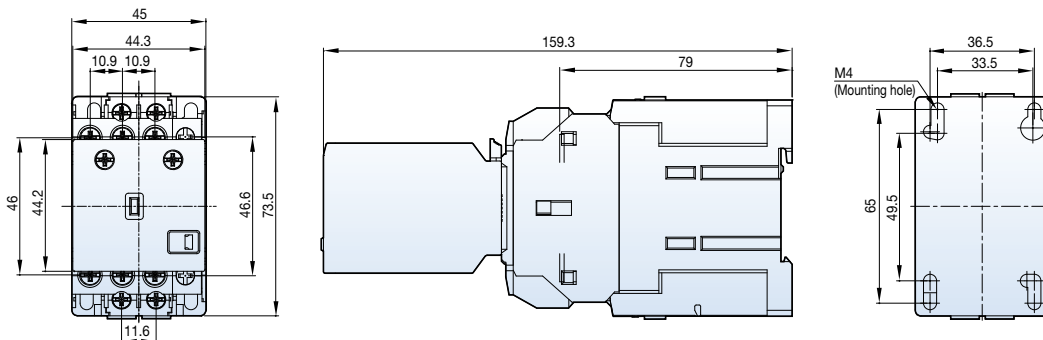

Dimension

Latching contactors 40AF

[mm]

MC-32a~40a AC
+ML-65

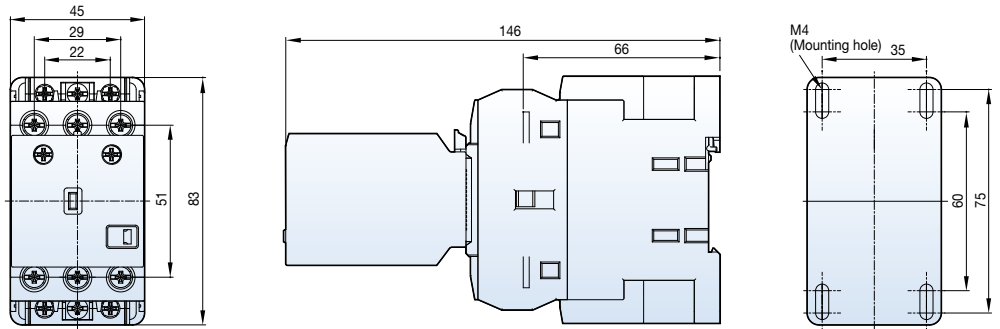

0.5kg

MC-32a~40a DC
+ ML-65

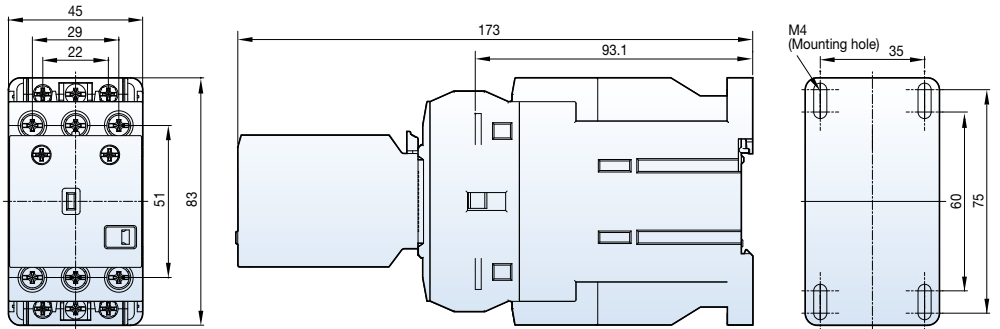

0.8kg

MC-32a~40a AC
2NO2NC + ML-65

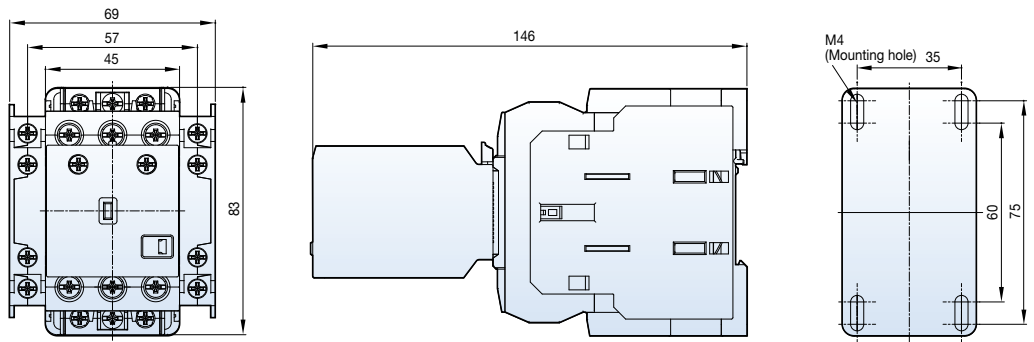

1kg

MC-32a~40a DC
2NO2NC + ML-65

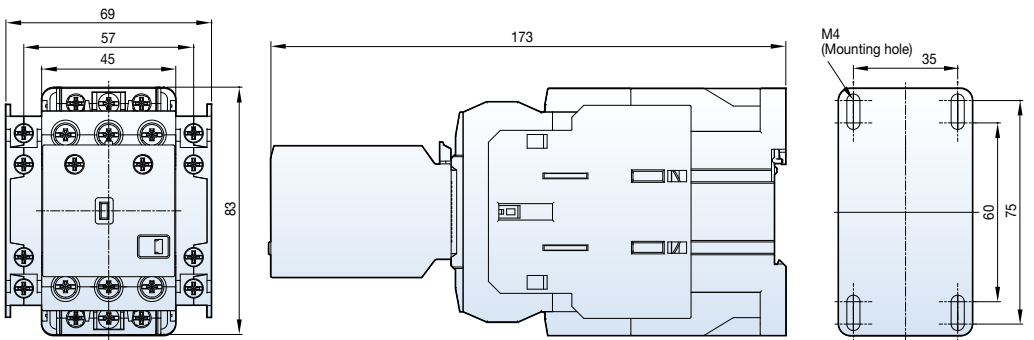

1.3kg

Latching contactors 65AF

[mm]

MC-50a~65a AC
+ ML-65

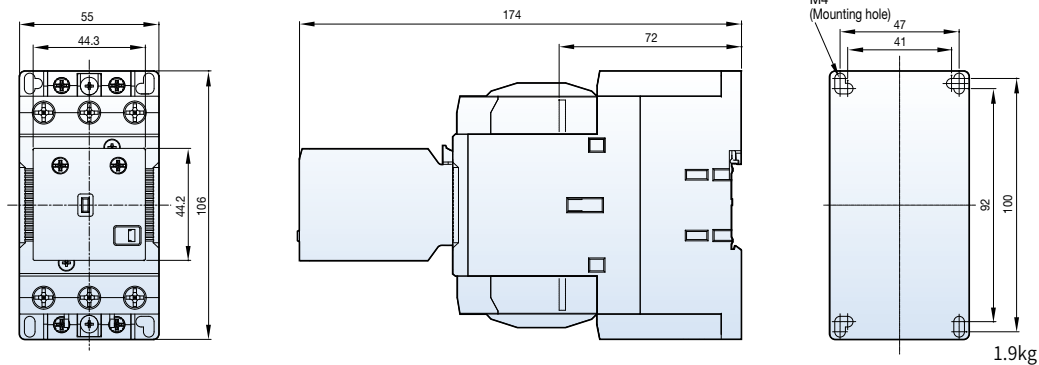

MC-50a~65a DC
+ ML-65

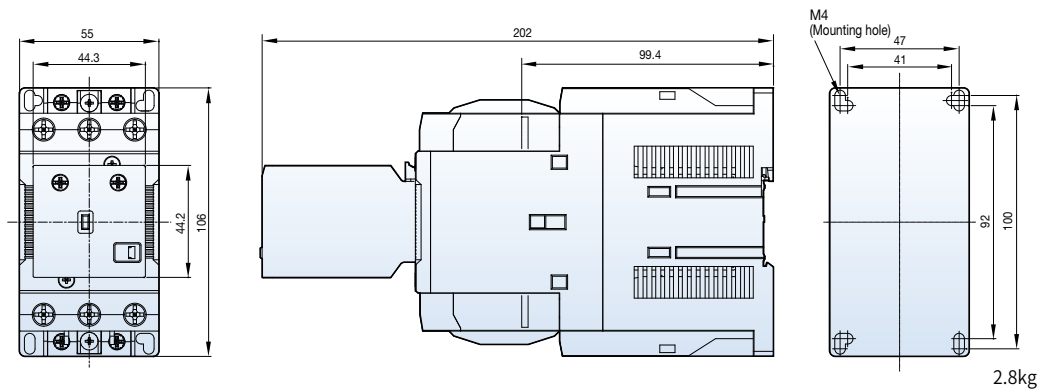

MC-50a~65a AC
2NO2NC + ML-65

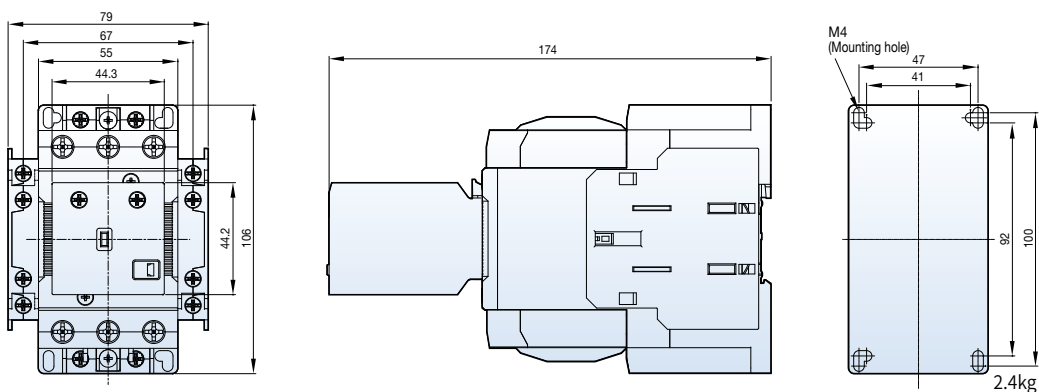

MC-50a~65a DC
2NO2NC + ML-65

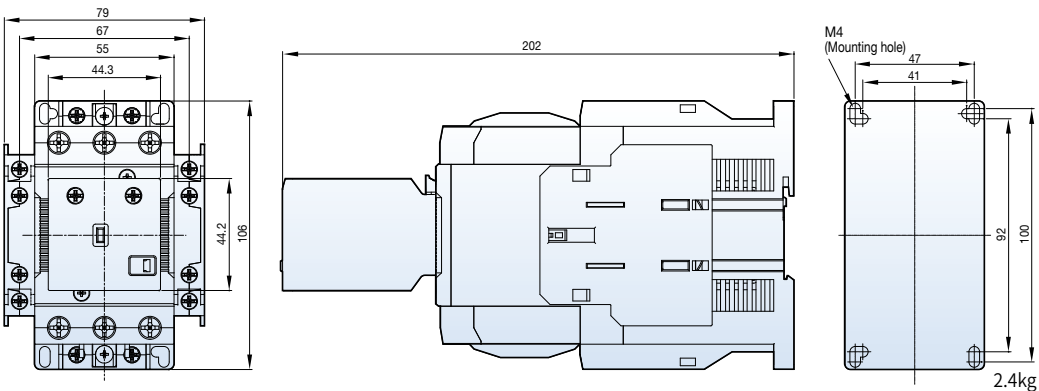

Dimension

Latching contactors 100AF

[mm]

MC-75a~100a AC

+ ML-150

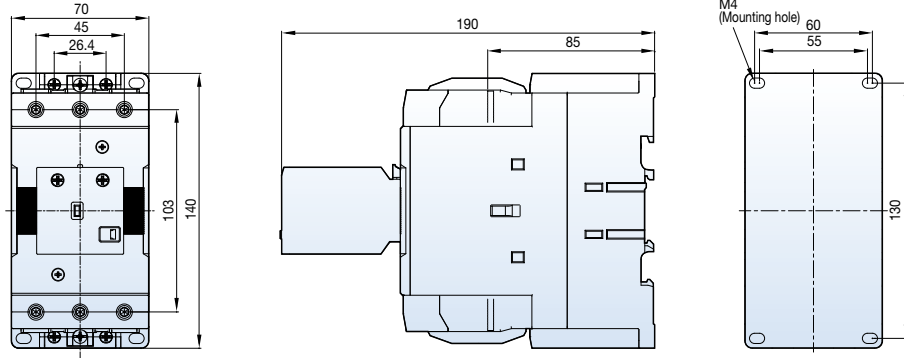

MC-75a~100a DC

+ ML-150

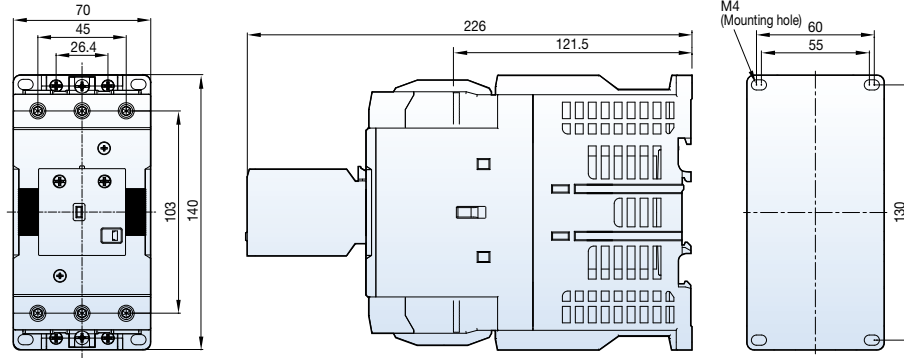

MC-75a~100a AC

2NO2NC + ML-150

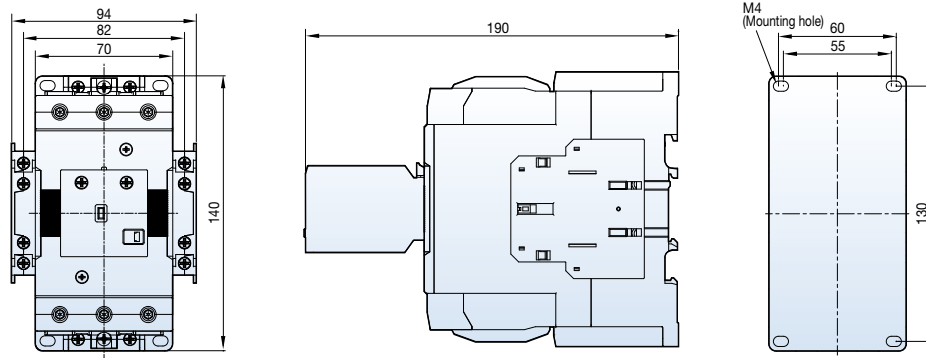

MC-75a~100a DC

2NO2NC + ML-150

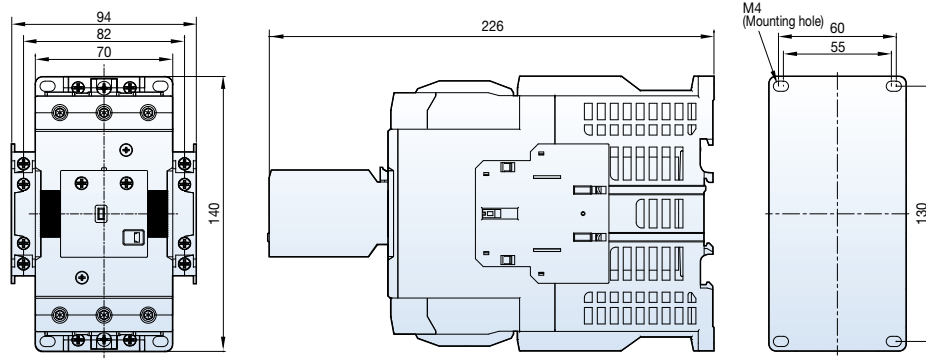

Latching contactors 150AF~400AF

[mm]

MC-130a~150a
2NO2NC + ML-150

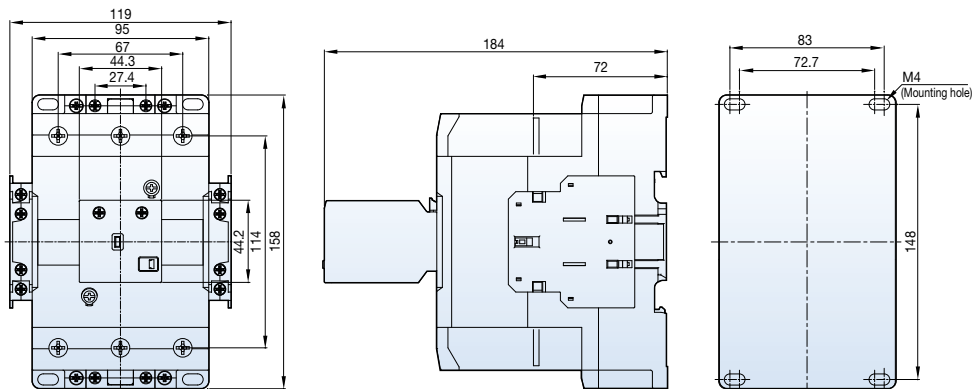

MC-185a
MC-225a

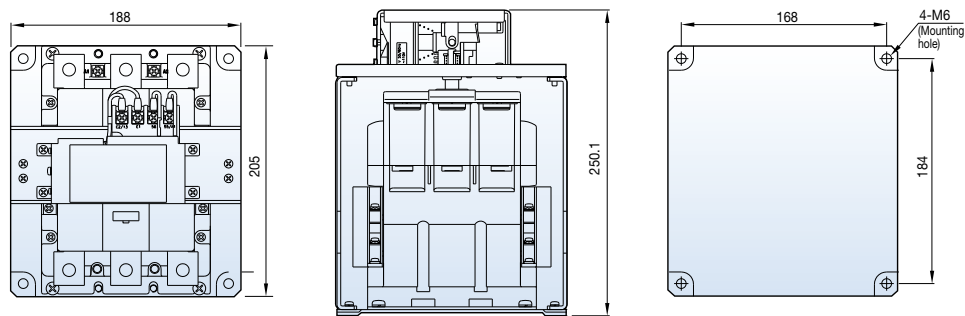

7.4kg

MC-265a
MC-330a
MC-400a

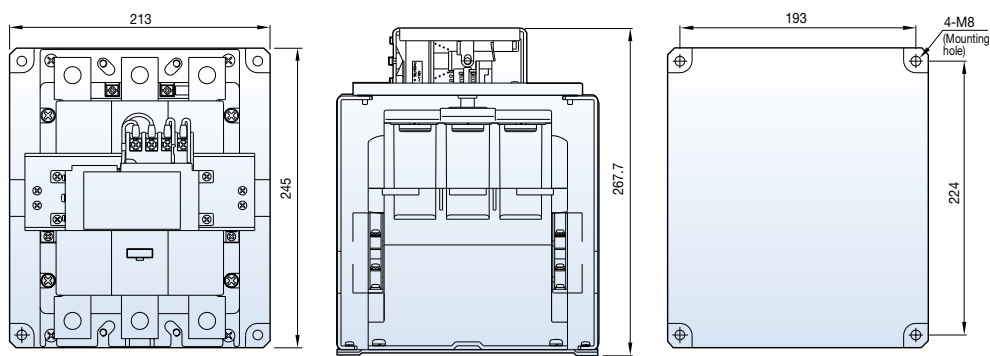

11.6kg

Composition

MC-185a/L~400a/L

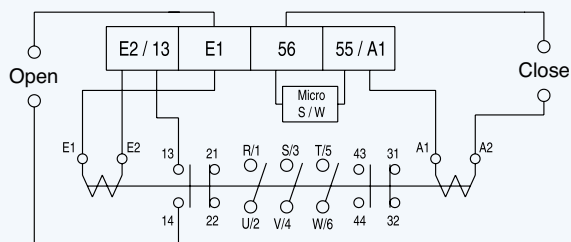

Dimension

4-pole contactors MC-6a/4~22a/4

[mm]

MC-6a/4~18a/4 AC

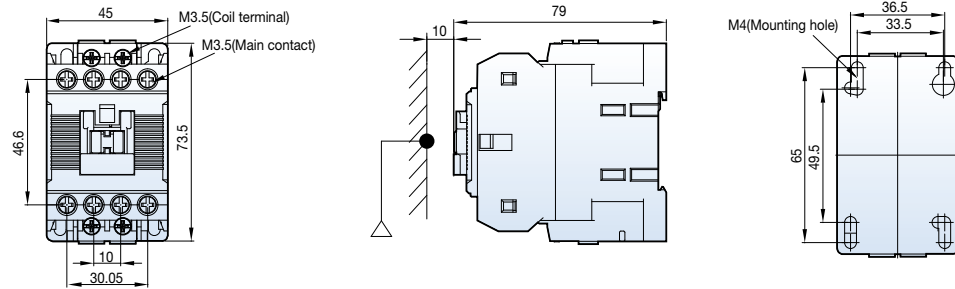

0.3kg

MC-6a/4~18a/4 DC

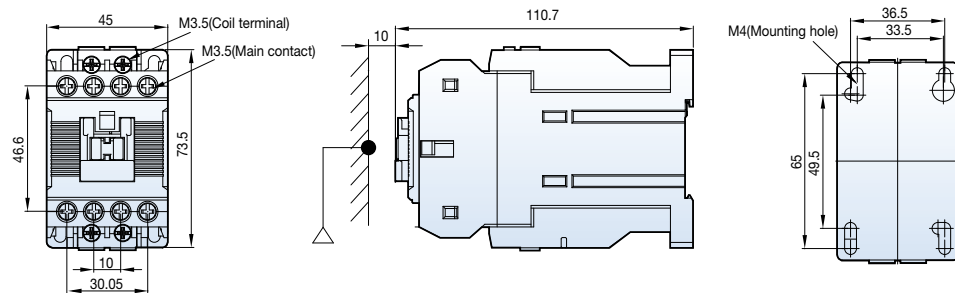

0.45kg

MC-22a/4 AC

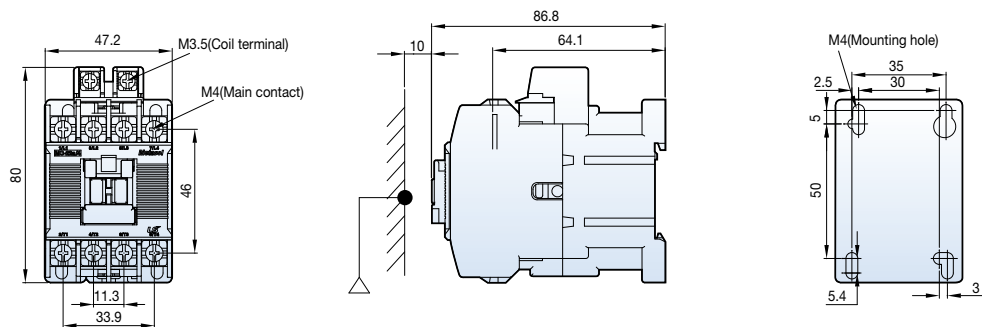

0.4kg

MC-22a/4 DC

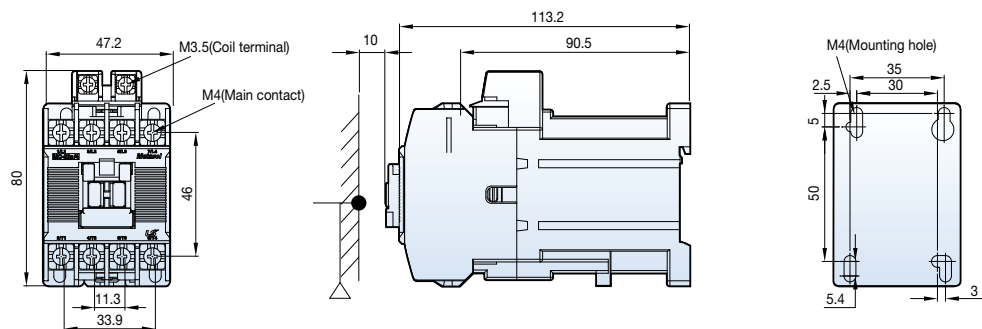

0.5kg

4-pole contactors MC-32a/4~85a/4

[mm]

MC-32a/4~40a/4 AC

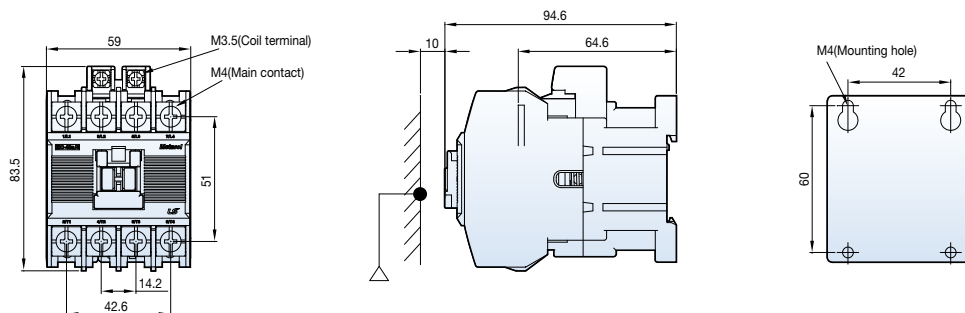

0.59kg

MC-32a/4~40a/4 DC

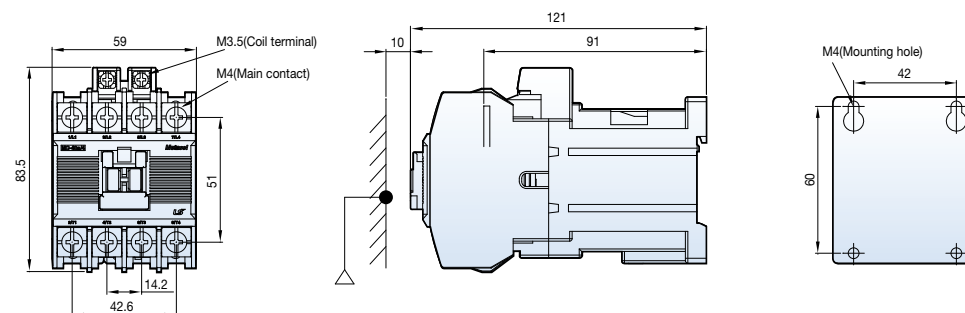

0.7kg

MC-50a/4~85a/4 AC

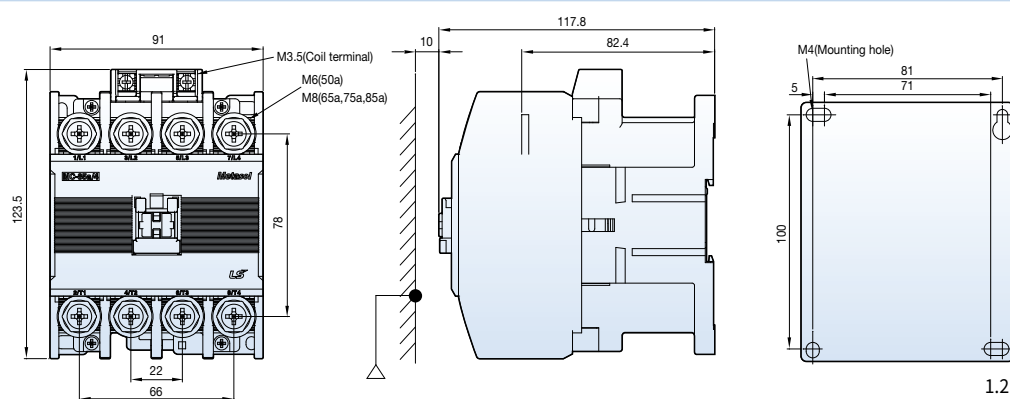

1.2kg

MC-50a/4~85a/4 DC

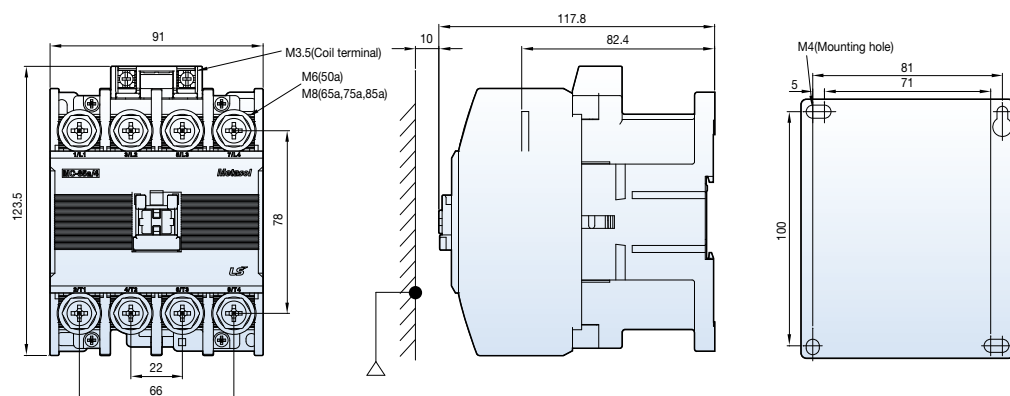

Dimension

4-pole contactors MC-100a/4~800a/4

[mm]

MC-100a/4

MC-130a/4

MC-150a/4

MC-185a/4

MC-225a/4

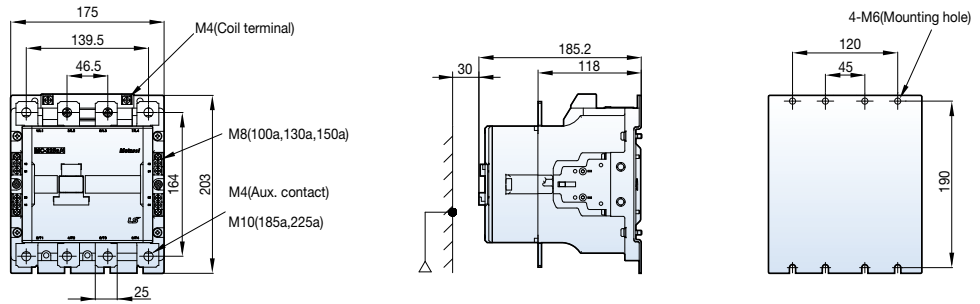

5.6kg

MC-265a/4

MC-330a/4

MC-400a/4

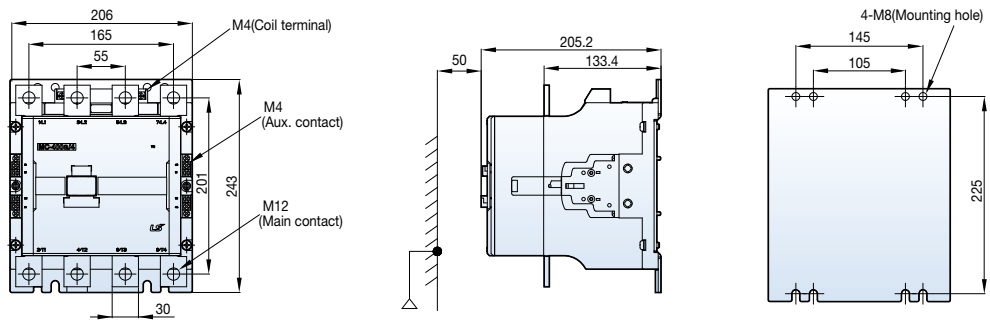

9.9kg

MC-500a/4

MC-630a/4

MC-800a/4

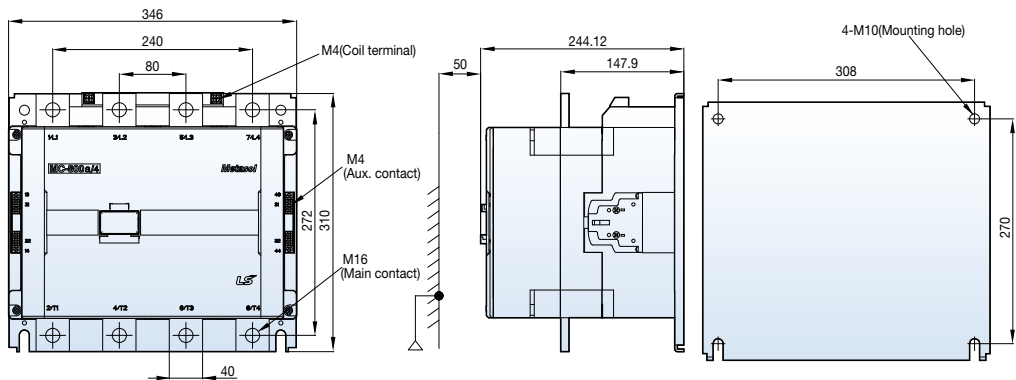

26.3kg

Enclosed motor starters, Mold enclosure

[mm]

MW-9bM~22bM

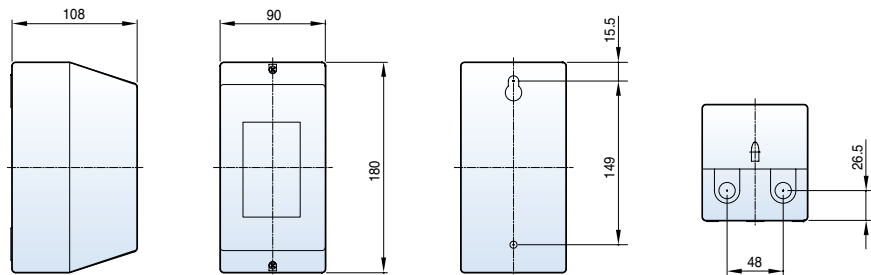

0.8kg

MW-9bMB~22bMB

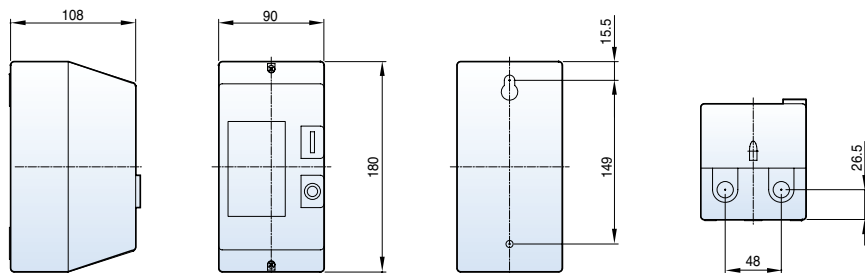

0.8kg

Circuit diagram

MW-9bM~22bM

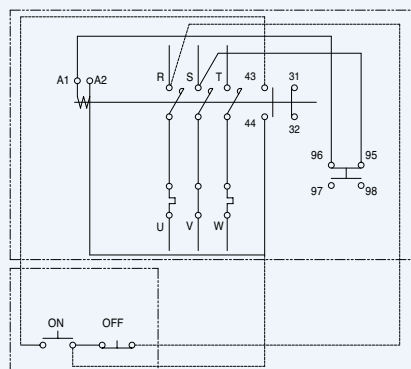

MW-9bMB~22bMB

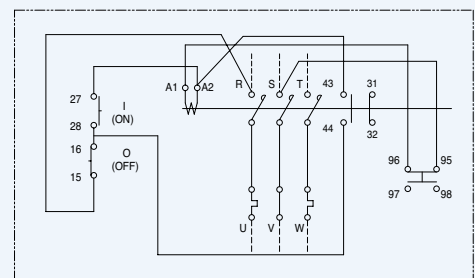

Dimension

Enclosed motor starters, Steel enclosure

[mm]

- MW-6a~100a
- MW-9b~22b

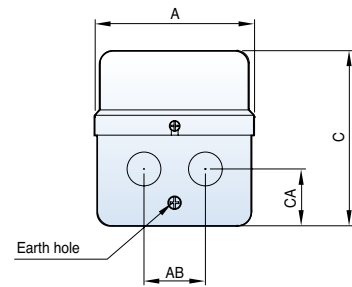
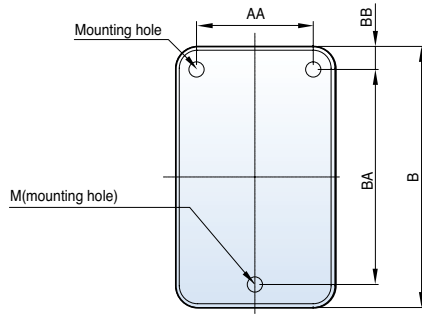

Type	A	AA	AB	B	BA	BB	C	CA	M	N	Weight(kg)
MW-9b~22b, 6a~18a	104	76	40	170	140	15	114	41	M5	Ø22	1.1
MW-32a, 40a	145	95	55	245	165	40	130	50	M5	Ø35	1.6
MW-50a, 65a	160	120	74	290	220	35	141	50	M5	Ø35	2.7
MW-75a, 85a, 100a	160	120	74	290	220	35	161	67	M5	Ø35	3.6

Circuit diagram

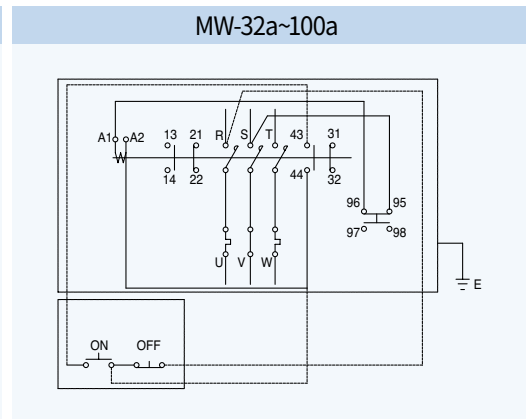
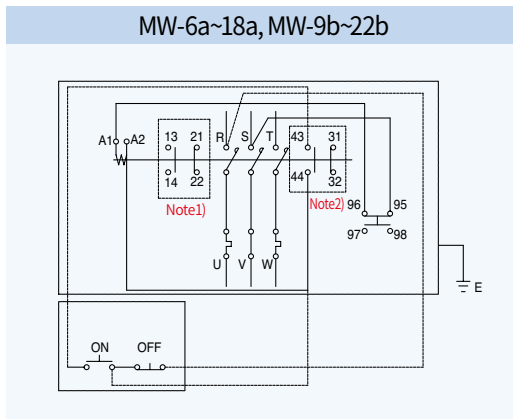

Note) 1. In case of adding the auxiliary contact unit(1NO1NC).
 2. See below for MC-6a~18a(1NO)



[mm]

MW-6aB~100aB
MW-9bB~22bB

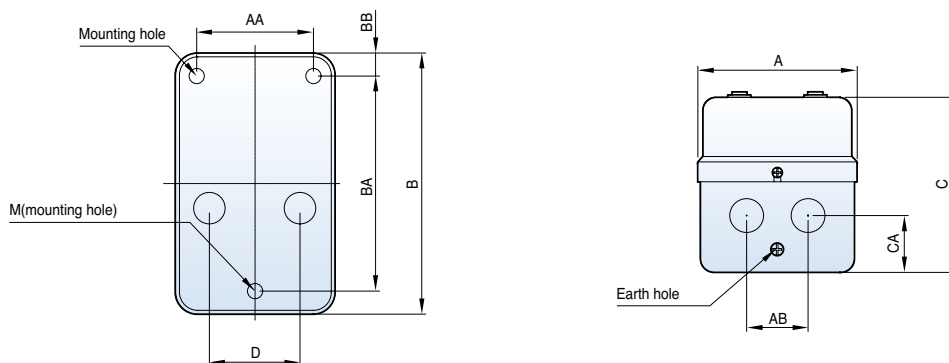

Type	A	AA	AB	B	BA	BB	C	CA	D	M	N	Weight(kg)
MW-9bB~22bB, 6aB~18aB	104	76	40	170	140	15	114	41	59	M5	Ø22	1.1
MW-32aB, 40aB	145	95	55	245	165	40	130	50	97	M5	Ø35	1.6
MW-50aB, 65aB	160	120	74	290	220	35	141	50	114	M5	Ø35	2.7
MW-75aB, 85aB, 100aB	160	120	74	290	220	35	161	67	114	M5	Ø35	3.6

Circuit diagram

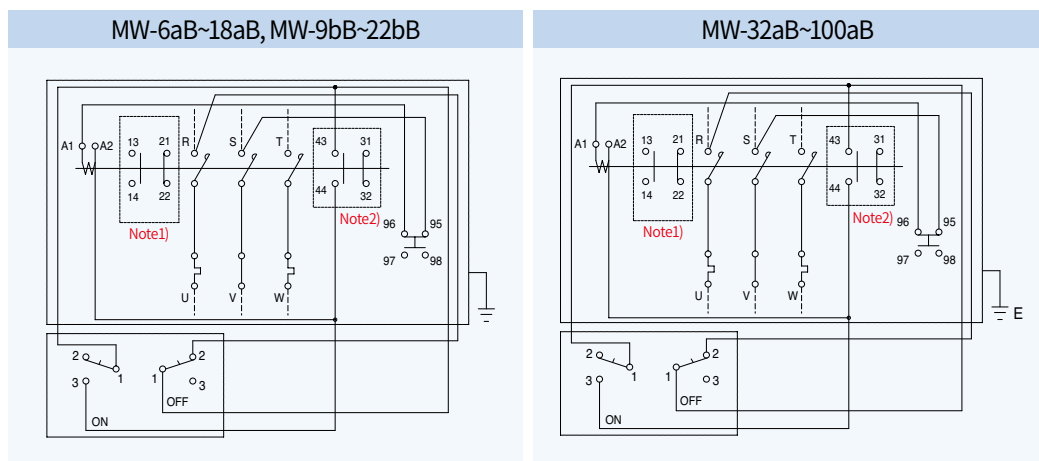

Note) 1. In case of adding the auxiliary contact unit(1NO1NC).
2. See below for MC-6a-18a(1NO)



Dimension

Capacitor contactors MC-9b~40a with AC-9, MC 50a~100a with AC-50

[mm]

MC-9b~22b
with AC-9

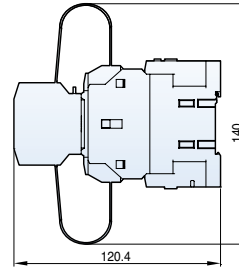
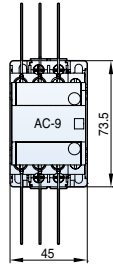

MC-32a,40a
with AC-9

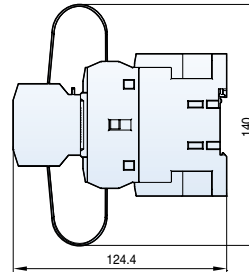
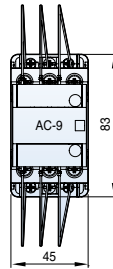

MC-50a,65a
with AC-50

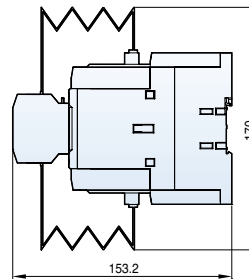
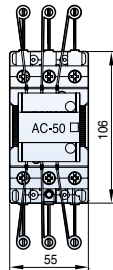

MC-75a~100a
with AC-50

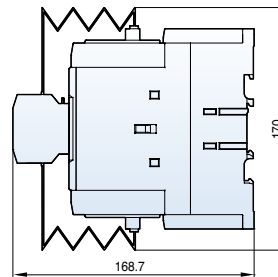
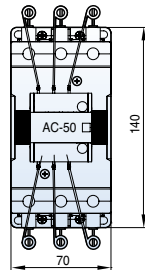

Circuit diagram

MC-9b~22b with AC-9

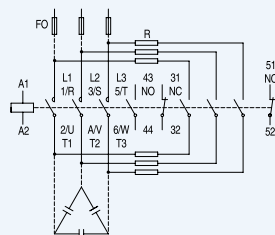

MC-32a, 40a with AC-9 MC 50a~100a with AC-50

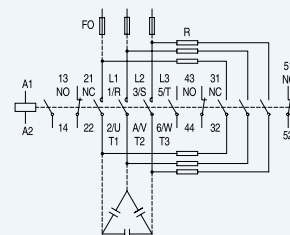

2-pole AC contactors GMC-10P2~40P2

[mm]

- GMC-10P2
 - GMC-20P2
 - GMC-25P2
 - GMC-30P2
 - GMC-35P2
 - GMC-40P2
- (TSBS Type)

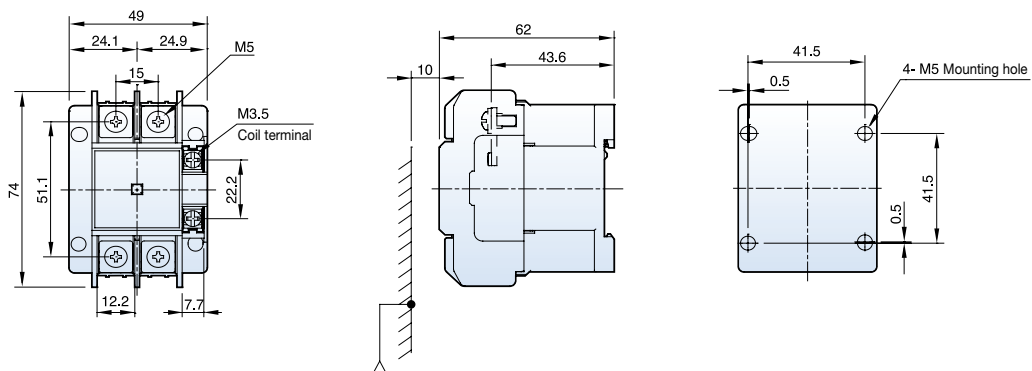

1.29kg

- GMC-10P2
 - GMC-20P2
 - GMC-25P2
 - GMC-30P2
 - GMC-35P2
 - GMC-40P2
- (TQBS Type)

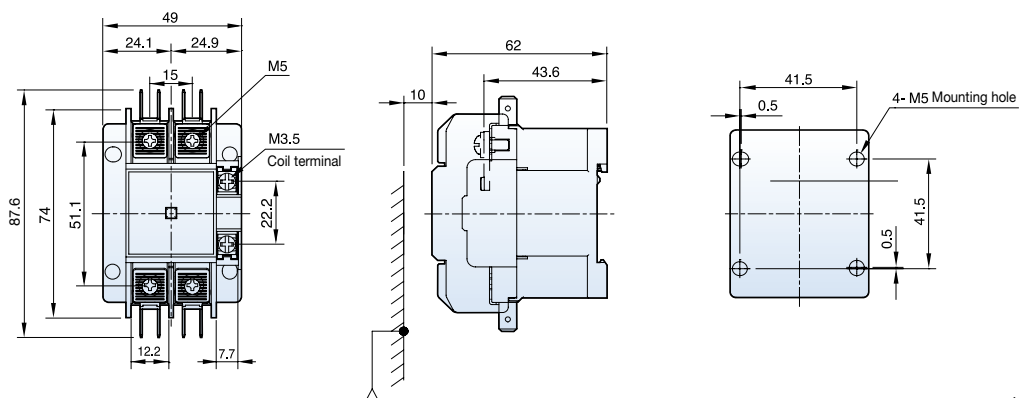

1.29kg

Composition

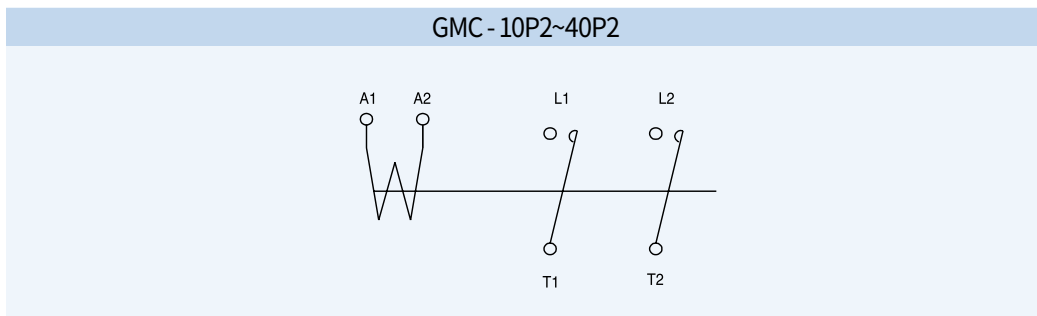

Terminal

Type	Terminals	Screw	Wire(mm ²)	Torque(kgf·cm)	A×B×C(mm)
GMC-10P2~40P2	Main	M5	1-16	26	12.2×7×8
	Coil	M3.5	1-2.5	12	7.7×7.5×4.5

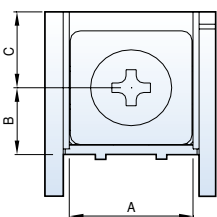

Dimension

3-pole AC Contactors GMC-20D, 25D

[mm]

- GMC-20D
- GMC-25D

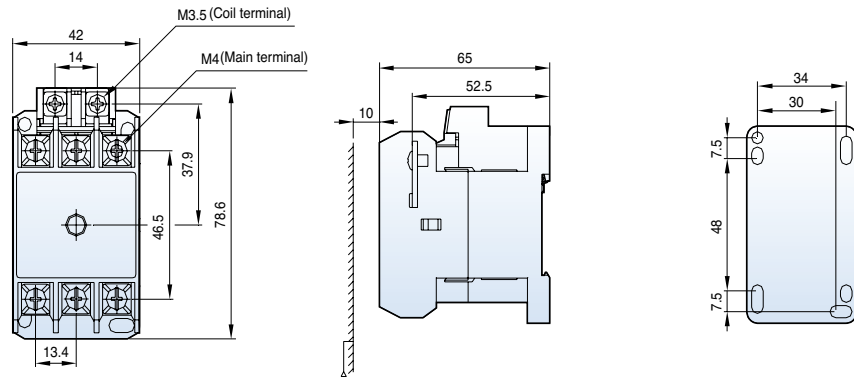

Contact arrangement

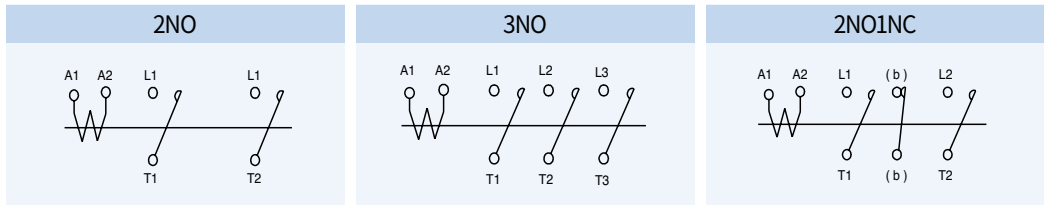

Terminal

Type	Screw	Wire(mm ²)	Torque(kgf-cm)	A×B×C(mm)
GMC-20D~25D	M4	1-10	15	9.4×5×85.1
Coil~	M3.5	1.25-2	12	8×5×4.9

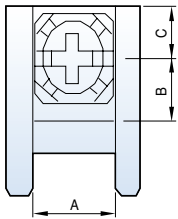

Single-pole AC Contactors MC-65aSP

MC-65aSP

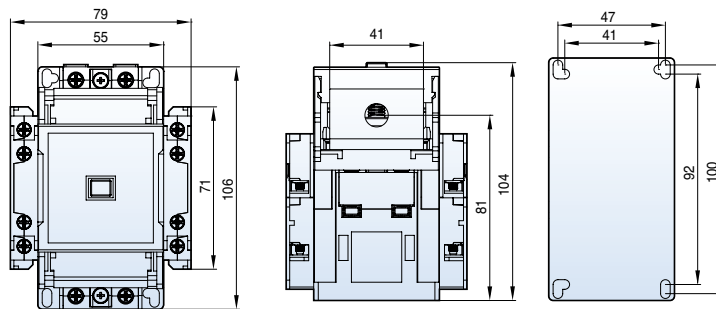

0.65kg

Composition

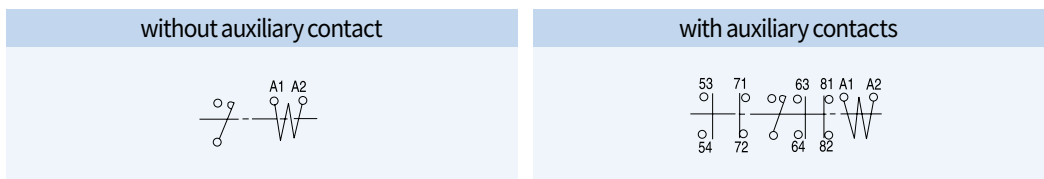

DC Contactors MD-30a, 60a, 100a

[mm]

MD-30a AC(DC)
2NO2NC

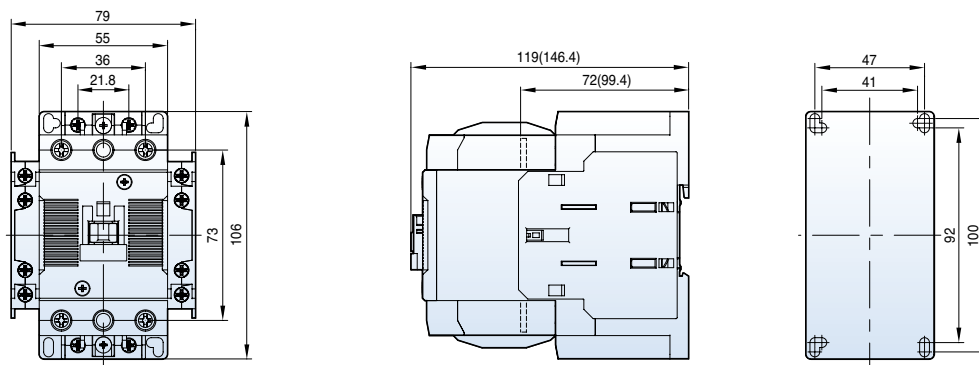

MD-60a,100a AC(DC)
2NO2NC

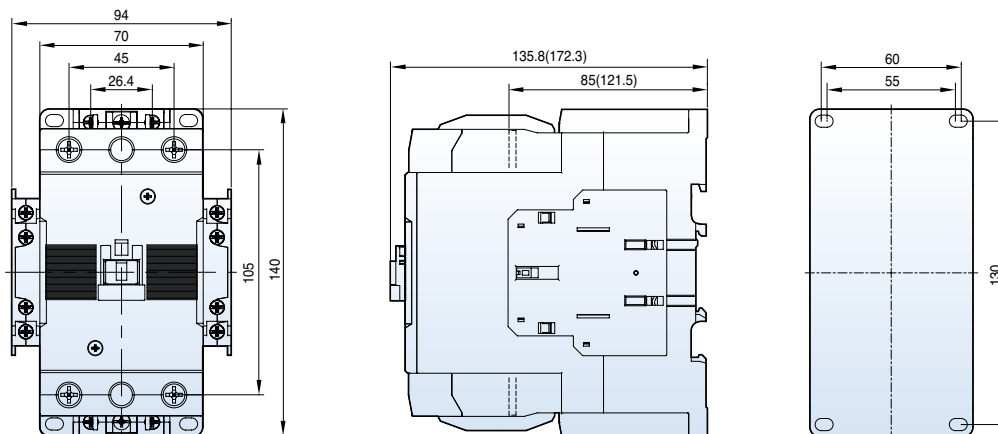

Composition

MD-30a, 60a, 100a

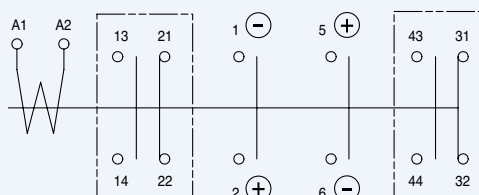

Contact arrangement

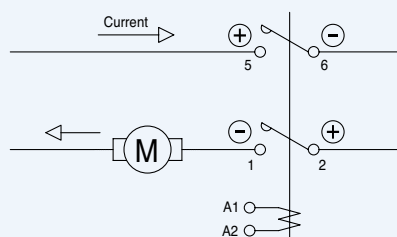

Dimension

Overload relays

[mm]

MT-12

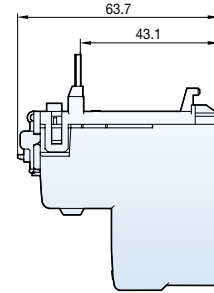
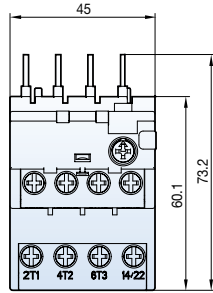

100g

MT-32

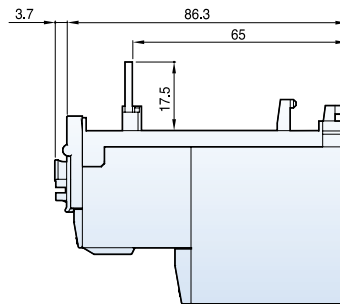
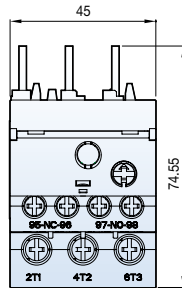

167g

MT-63

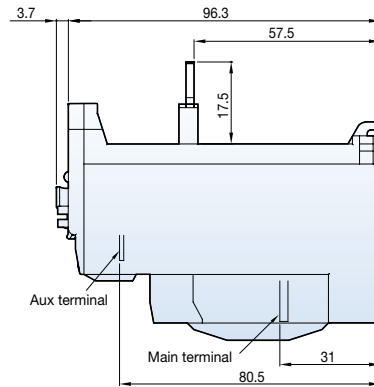
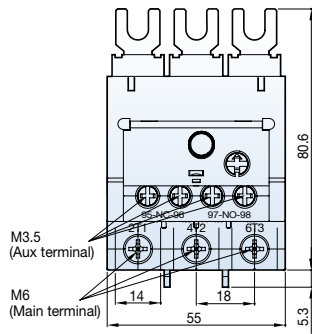

303g

MT-95

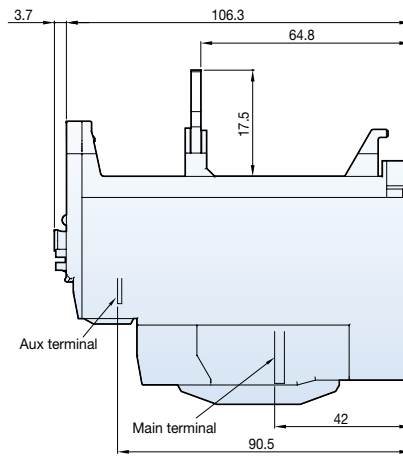
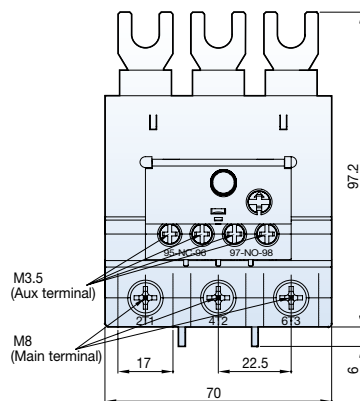

474g

[mm]

MT-150

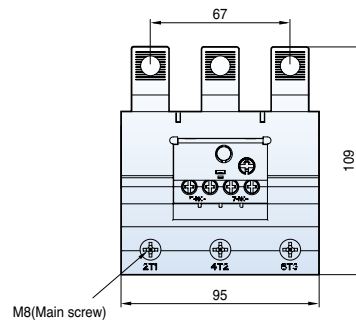

0.7kg

MT-225

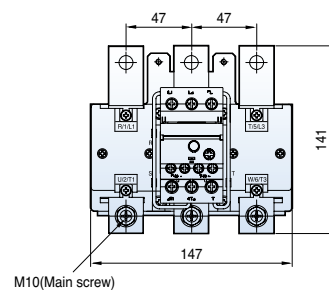

2.5kg

MT-400

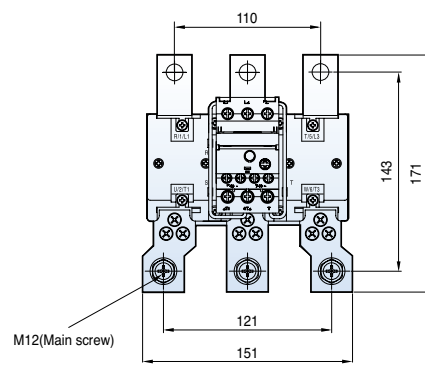

2.6kg

MT-800

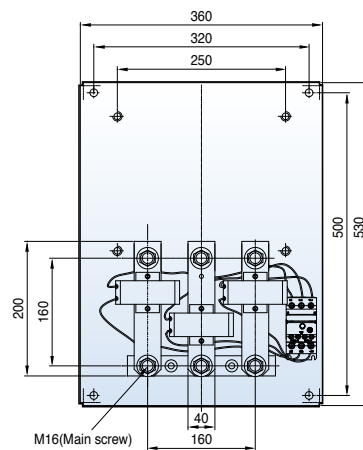

11.5kg

Dimension (Separate mount)

Overload relays

[mm]

UZ-12

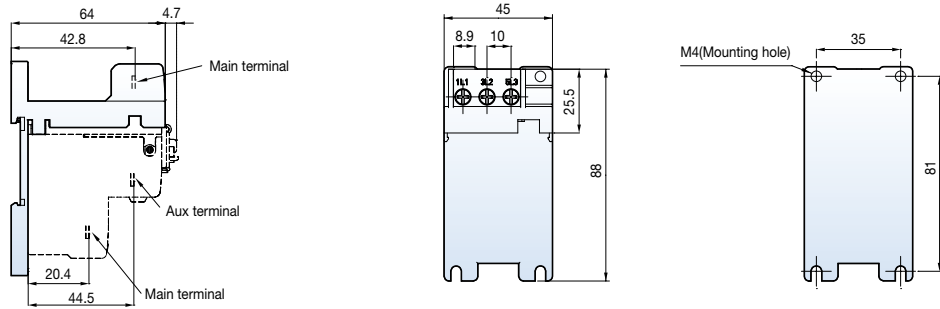

35g

UZ-32

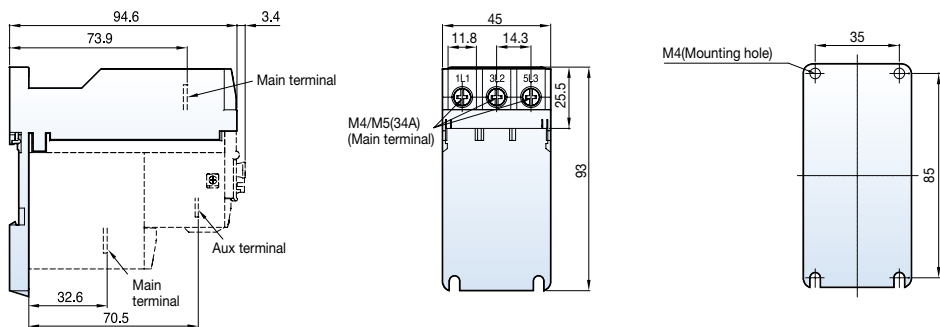

68g

UZ-63

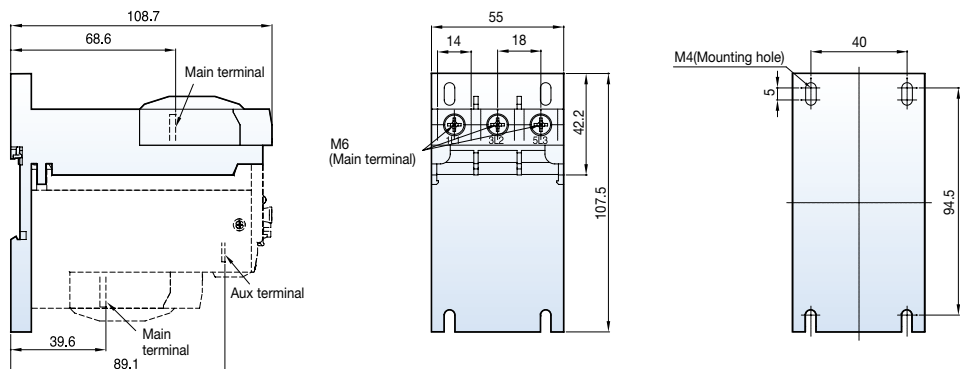

134g

[mm]

UZ-95

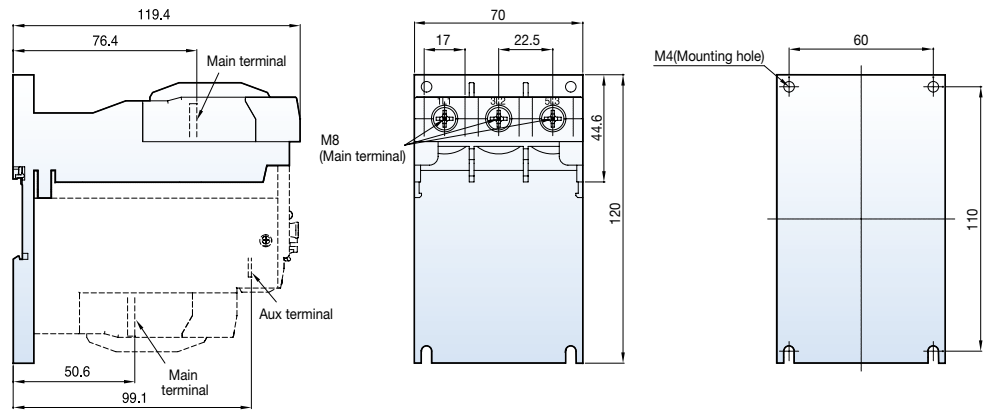

230g

UZ-150

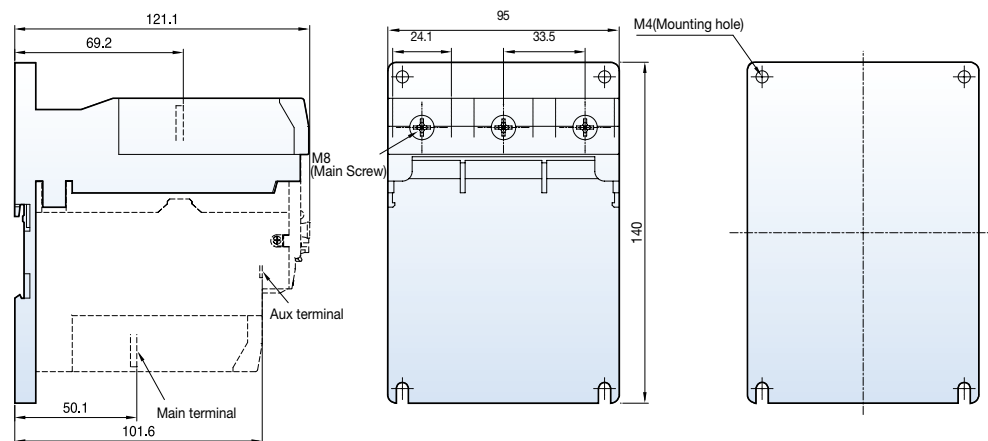

284g

Delayed opening device

Dimension

AD - 9

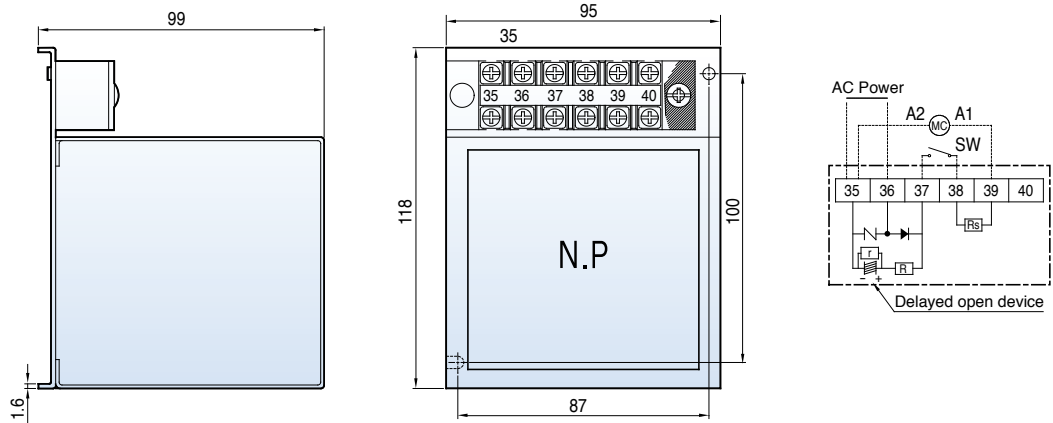

AD - 50

AD - 100

AD - 300

AD - 600

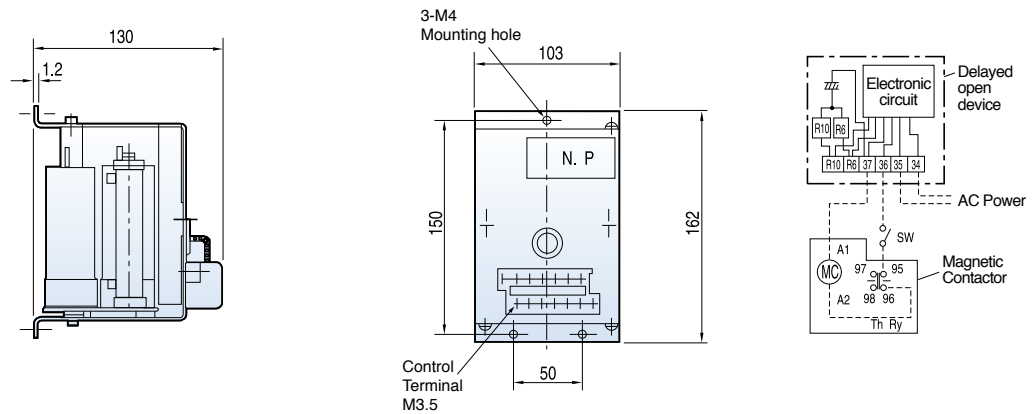

0.5kg

Control circuit diagram

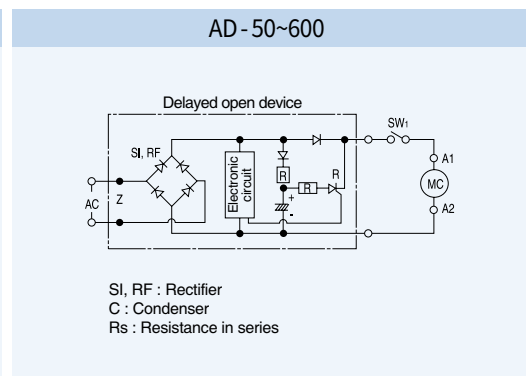
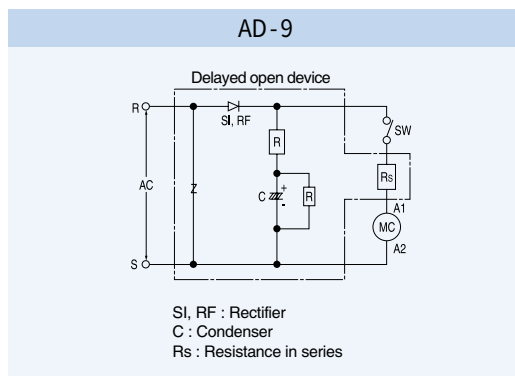

ON delay timer

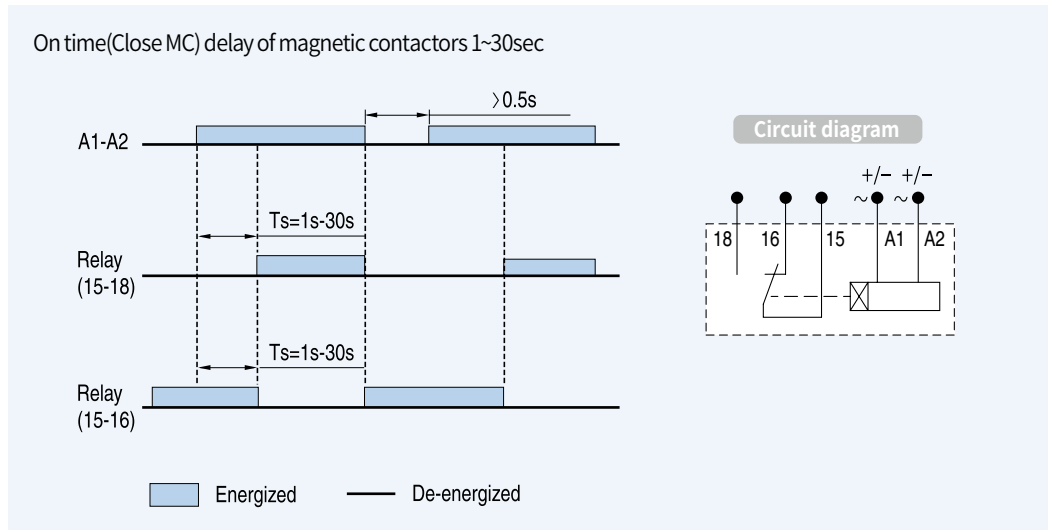

OFF delay timer

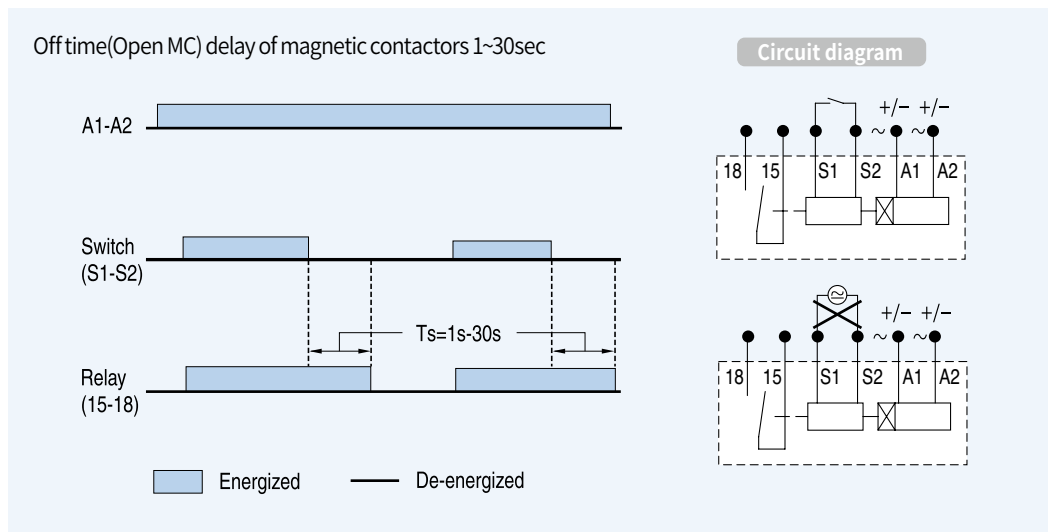

Dimension

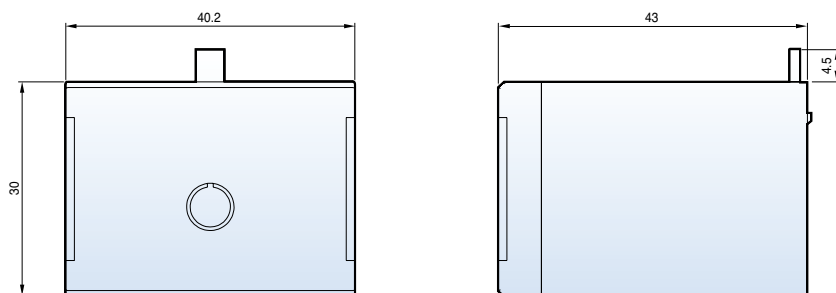

Contact arrangement

Contactors

MC-6a~18a

1NO

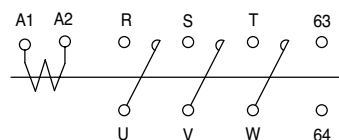

1NC

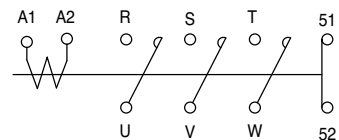

MC-9b~22b

1NO1NC

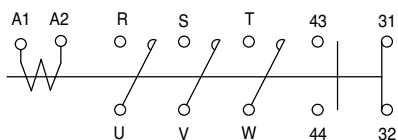

MC-32a~2650a

2NO2NC

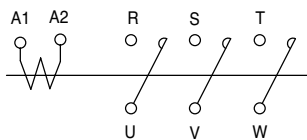
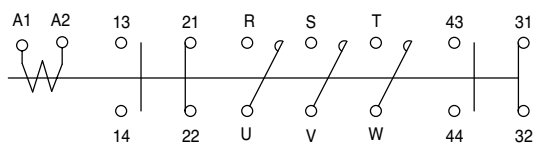

Motor starters

MS-6a~150a

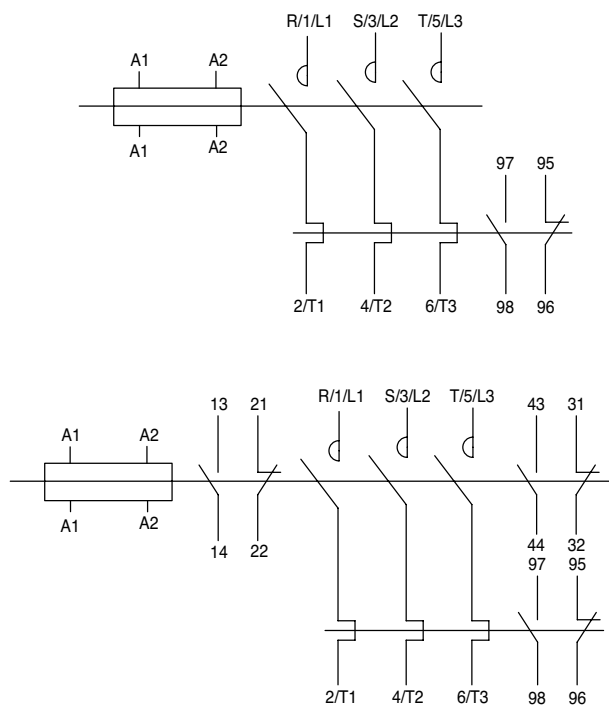

MS-185a~800a

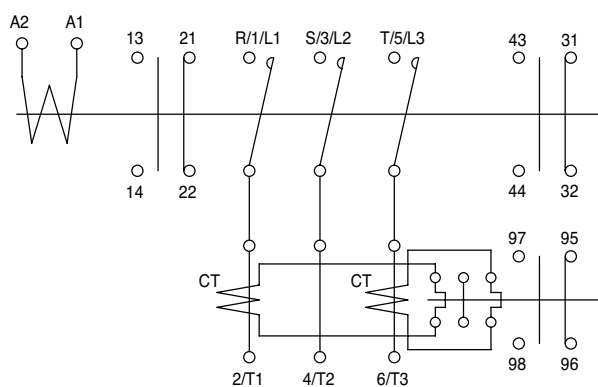

Contact arrangement

Reversing contactors

MC-6aR~150aR

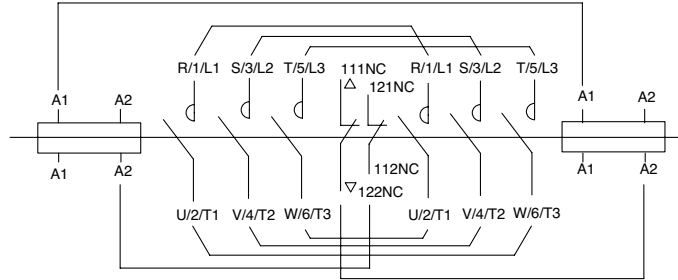

MC-185aR~800aR

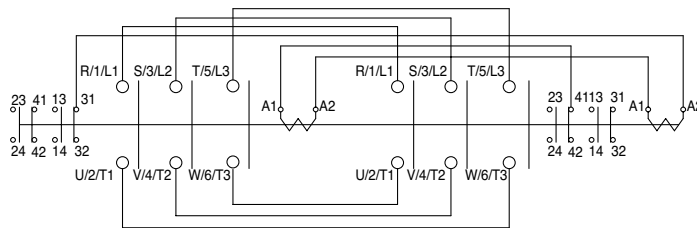

MS-6aR~150aR

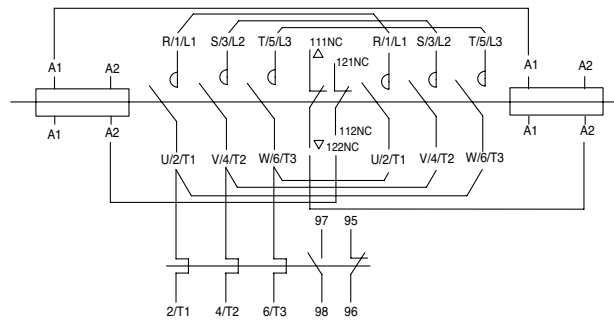

MS-185aR~400aR

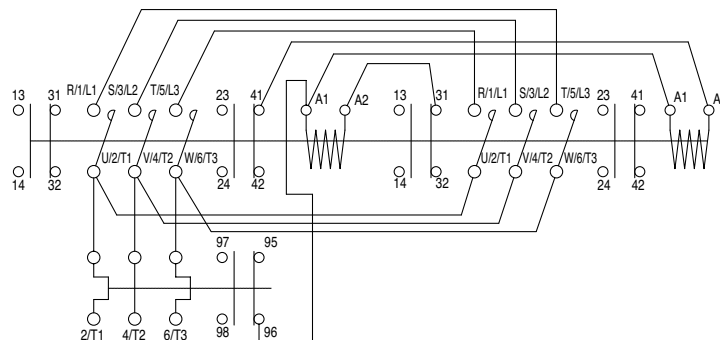

Meta-MEC and Metasol MC comparison table

Metasol MS

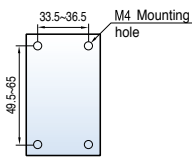
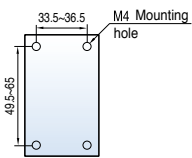
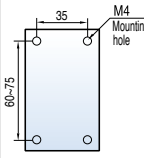
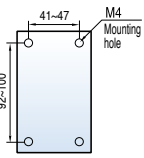
		Type	MC-6a	MC-9a	MC-12a	MC-18a	MC-9b	MC-12b	MC-18b	MC-22b	MC-32a	MC-40a	MC-50a	MC-65a	
Manufactured products	Metasol MC	Current and power AC3	200~240V	2.2kW 9A	2.5kW 11A	3.5kW 13A	4.5kW 18A	2.5kW 11A	3.5kW 13A	4.5kW 18A	5.5kW 22A	7.5kW 32A	11kW 40A	15kW 55A	18.5kW 65A
			380~440V	3kW 7A	4kW 9A	5.5kW 12A	7.5kW 18A	4kW 9A	5.5kW 12A	7.5kW 18A	11kW 22A	15kW 32A	18.5kW 40A	22kW 50A	30kW 65A
		500~550V	3kW 6A	4kW 7A	7.5kW 12A	7.5kW 13A	4kW 7A	7.5kW 12A	7.5kW 13A	15kW 20A	18.5kW 28A	22kW 32A	30kW 43A	33kW 60A	
			Auxiliary (Standard)	1NO or 1NC				1NO1NC				-		-	
	Mounting size														
	Weight (kg)		0.33				0.34				0.4		0.9		
	Demension(W×H×D)		45×73.5×80.4				45×73.5×87.4				45×83×90		55×106×119		

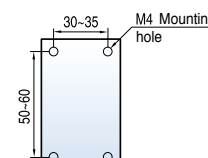
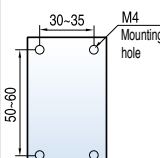
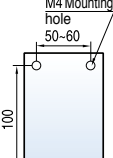
		Type	-	GMC-9	GMC-12	GMC-18	GMC-22	GMC-32	GMC-40	GMC-50	GMC-65		
Discontinued products	Meta-MEC MC	Current and power AC3	200~220V	-	2.5kW 11A	3.5kW 13A	4.5kW 18A	5.5kW 22A	7.5kW 32A	11kW 40A	15kW 55A	18.5kW 65A	
			380~440V	-	4kW 9A	5.5kW 12A	7.5kW 18A	11kW 22A	15kW 32A	18.5kW 40A	22kW 50A	30kW 65A	
		500~550V	4kW 7A	7.5kW 12A	7.5kW 13A	15kW 22A	18.5kW 28A	22kW 32A	30kW 43A	33kW 60A			
			Auxiliary (Standard)	-	1NO1NC	1NO1NC	1NO1NC	1NO1NC	2NO2NC	2NO2NC	2NO2NC	2NO2NC	
	Mounting size		-										
	Weight (kg)		-				0.33		0.37		0.45		1
	Demension(W×H×D)		-				44×80×86.8				68×82×94.6		94×122×115.7
	Compatibility with Metasol		-				○				▲		▲

Note) Marks of compatibility

○: can be compatible

▲: compatible when applied the bracket

×: can't be compatible(have to use bracket)

Meta-MEC and Metasol MC comparison table

		Type	MC-75a	MC-85a	MC-100a	MC-130a	MC-150a	MC-185a	MC-225a	MC-265a	MC-330a	MC-400a	MC-500a	MC-630a	MC-800a	
Manufactured products	Metasol MC	Current and power AC3	200~240V	22 kW 75A	25kW 85A	30kW 105A	37kW 130A	45kW 150A	55kW 185A	75kW 225A	80kW 265A	90kW 330A	125kW 400A	147kW 500A	190kW 630A	220kW 800A
			380~440V	37 kW 75A	45kW 85A	55kW 105A	60kW 130A	75kW 150A	90kW 185A	132kW 225A	147kW 265A	160kW 330A	200kW 400A	265kW 500A	330kW 630A	440kW 800A
		500~550V	37 kW 64A	45 kW 75A	55kW 85A	60kW 90A	70kW 100A	110kW 180A	132kW 200A	147kW 225A	160kW 280A	225kW 350A	265kW 400A	330kW 500A	500kW 630A	720A
			Auxiliary (Standard)	-			-		2NO2NC		2NO2NC			2NO2NC		
	Mounting size															
	Weight (kg)	1.6		2.4		5.4		9.2			22.4					
	Demension(W×H×D)	70×140×135.8		95×158×130.3		138×203×185.1		163×243×204.4			285×312×245.3					

		Type	GMC-75	GMC-85	GMC-100	GMC-125	GMC-150	GMC-180	GMC-220	-	GMC-300	GMC-400	-	GMC-600	GMC-800	
Discontinued products	Meta-MEC MC	Current and power AC3	200~220V	22kW 75A	25kW 85A	30kW 105A	37kW 125A	45kW 150A	55kW 180A	75kW 250A	-	90kW 300A	125kW 400A	-	190kW 630A	220kW 800A
			380~440V	37kW 75A	45kW 85A	55kW 105A	60kW 120A	75kW 150A	90kW 180A	132kW 250A	-	160kW 300A	200kW 400A	-	330kW 630A	440kW 800A
		500~550V	37kW 64A	45kW 75A	55kW 85A	60kW 90A	90kW 140A	110kW 180A	132kW 200A	-	160kW 250A	225kW 350A	-	330kW 500A	500kW 720A	
			Auxiliary (Standard)	2NO2NC	2NO2NC	2NO2b	2NO2NC	2NO2NC	2NO2NC	2NO2NC	-	2NO2NC	2NO2NC	-	2NO2NC	2NO2NC
	Mounting size															
	Weight (kg)	1		2.9		3.4		5.4		-			9.2		-	
	Demension(W×H×D)	94×122×115.7		100×157.4×146.5		120×166×157		138×203×181		-			163×243×198		-	
Compatibility with Metasol	▲		×		×		○		-			○		-		

Note) Marks of compatibility
 ○: can be compatible
 ▲: compatible when applied the bracket
 ×: can't be compatible(have to use bracket)

Meta-MEC and Metasol MS comparison table

Metasol MS

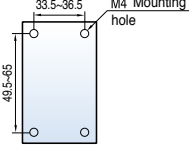
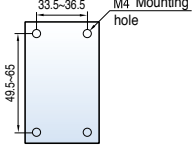
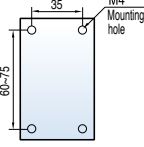
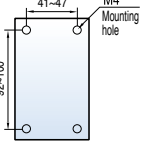
Type		MS-6a	MS-9a	MS-12a	MS-18a	MS-9b	MS-12b	MS-18b	MS-22b	MS-32a	MS-40a	MS-50a	MS-65a		
Manufactured products	Metasol MC	Current and power AC3	200~240V	2.2kW 9A	2.5kW 11A	3.5kW 13A	4.5kW 18A	2.5kW 11A	3.5kW 13A	4.5kW 18A	5.5kW 22A	7.5kW 32A	11kW 40A	15kW 55A	18.5kW 65A
			380~440V	3kW 7A	4kW 9A	5.5kW 12A	7.5kW 18A	4kW 9A	5.5kW 12A	7.5kW 18A	11kW 22A	15kW 32A	18.5kW 40A	22kW 50A	30kW 65A
		500~550V	3kW 6A	4kW 7A	7.5kW 12A	7.5kW 13A	4kW 7A	7.5kW 12A	7.5kW 13A	15kW 20A	18.5kW 28A	22kW 32A	30kW 43A	33kW 60A	
			Auxiliary (Standard)	1NO or 1NC				1NO1NC				-		-	
	Mounting size														
	Weight (kg)	0.5				0.5				0.7		1.5			
	Demension(W×H×D)	45×124×80.4				45×129.9×87.4				45×139.4×90		55×163.8×119			

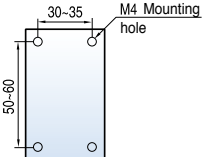
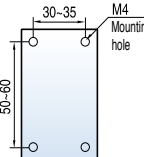
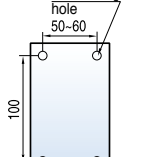
Type		-	GMS-9	GMS-12	GMS-18	GMS-22	GMS-32	GMS-40	GMS-50	GMS-65			
Discontinued products	Meta-MEC MC	Current and power AC3	200~220V	-	-	2.5kW 11A	3.5kW 13A	4.5kW 18A	5.5kW 22A	7.5kW 32A	11kW 40A	15kW 55A	18.5kW 65A
			380~440V	-	-	4kW 9A	5.5kW 12A	7.5kW 18A	11kW 22A	15kW 32A	18.5kW 40A	22kW 50A	30kW 65A
		500~550V	-	-	4kW 7A	7.5kW 12A	7.5kW 13A	15kW 22A	18.5kW 28A	22kW 32A	30kW 43A	33kW 60A	
			Auxiliary (Standard)	-	1NO1NC	1NO1NC	1NO1NC	1NO1NC	2NO2NC	2NO2NC	2NO2NC	2NO2NC	
	Mounting size	-											
	Weight (kg)	-	0.46		0.5		0.45		1.12				
	Demension(W×H×D)	-	44×128.9×86.8				68×136.5×94.6		94×181.5×115.7				
	Compatibility with Metasol	-	○				×		×				



Note) Marks of compatibility

○: can be compatible

×: can't be compatible(have to use bracket)

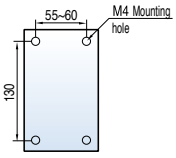
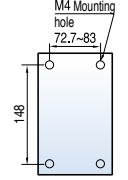
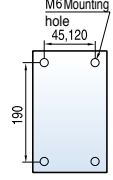
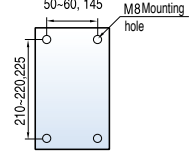
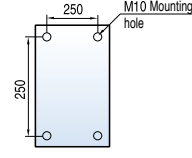
Meta-MEC and Metasol MS comparison table

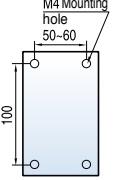
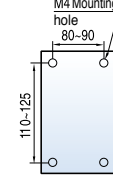
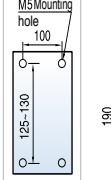
		Type	MS-75a	MS-85a	MS-100a	MS-130a	MS-150a	MS-185a	MS-225a	MS-265a	MS-330a	MS-400a	MS-500a	MS-630a	MS-800a	
Manufactured products	Metasol MC	Current and power AC3	200~240V	22 kW 75A	25kW 85A	30kW 105A	37kW 130A	45kW 150A	55kW 185A	75kW 225A	80kW 265A	90kW 330A	125kW 400A	147kW 500A	190kW 630A	220kW 800
			380~440V	37 kW 75A	45kW 85A	55kW 105A	60kW 130A	75kW 150A	90kW 185A	132kW 225A	147kW 265A	160kW 330A	200kW 400A	265kW 500A	330kW 630A	440kW 800A
		500~550V	37 kW 64A	45 kW 75A	55kW 85A	60kW 90A	70kW 100A	110kW 180A	132kW 200A	147kW 225A	160kW 280A	225kW 350A	265kW 400A	330kW 500A	500kW 500A	720A 720A
	Auxiliary (Standard)		-			-		2NO2NC		2NO2NC			2NO2NC			
	Mounting size															
	Weight (kg)		2.4			3		7.9		11.8			28			
	Demension(W×H×D)		70×211.4×135.8			95×236.2×130.3		138×306.5×185.1		163×380×204.4			360×530×245.3			

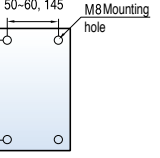
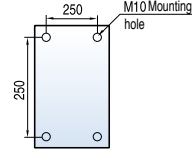
		Type	GMC-75	GMC-85	GMC-100	GMC-125	GMC-150	GMC-180	GMC-220	-	GMC-300	GMC-400	-	GMC-600	GMC-800		
Discontinued products	Meta-MEC MC	Current and power AC3	200~220V	22kW 75A	25kW 85A	30kW 105A	37kW 125A	45kW 150A	55kW 180A	75kW 250A	-	90kW 300A	125kW 400A	-	190kW 630A	220kW 800A	
			380~440V	37kW 75A	45kW 85A	55kW 105A	60kW 120A	75kW 150A	90kW 180A	132kW 250A	-	160kW 300A	200kW 400A	-	330kW 630A	440kW 800A	
		500~550V	37kW 64A	45kW 75A	55kW 85A	60kW 90A	90kW 140A	110kW 180A	132kW 200A	-	160kW 250A	225kW 350A	-	330kW 500A	500kW 720A		
	Auxiliary (Standard)		2NO2NC	2NO2NC	2NO2NC	2NO2NC	2NO2NC	2NO2NC	2NO2NC	-	2NO2NC	2NO2NC	-	2NO2NC	2NO2NC		
	Mounting size																
	Weight (kg)		1.12		3.4		4		7.9		-			11.8		-	
	Demension(W×H×D)		94×181.5×115.7		114×231.4×146.5		120×206.4×157		138×306.54×181		-			163×380×198		-	
Compatibility with Metasol		×			×		○		-			○		-			

Note) Marks of compatibility
 ○: can be compatible
 ×: can't be compatible(have to use bracket)

Meta-MEC and Metasol relays comparison table

Metasol MS

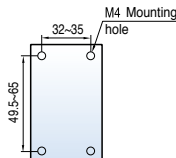
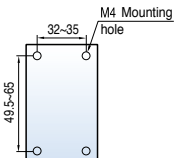
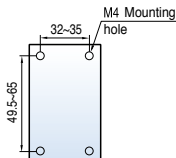
Type		MR-4	MR-6	MR-8
Manufactured products	Metasol MR			
	Auxiliary (kW)	4NO, 3NO1NC, 2NO2NC 1NO3NC, 4NC	6NO, 5NO1NC, 4NO2NC 3NO3NC, 2NO4NC	8NO, 7NO1NC, 6NO2NC 5NO3NC, 4NO4NC
	Rated current (A) 120 V	6	6	6
	AC15 240 V	3	3	3
	Mounting size			
	Dimension (W×H×D)	45×73.5×79(96.6)	45×73.5×109.6(127.2)	45×73.5×109.6(127.2)
Weight (kg)	0.284	0.315	0.339	

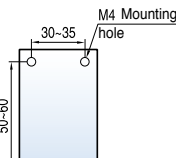
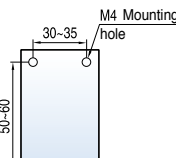
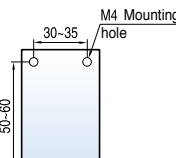
Type		GMR-4(D)	GMR-6(D)	GMR-8(D)
Discontinued products	GMR			
	Auxiliary (kW)	4NO, 3NO1NC, 2NO2NC 1NO3NC, 4NC	6NO, 5NO1NC, 4NO2NC 3NO3NC, 2NO4NC	8NO, 7NO1NC, 6NO2NC 5NO3NC, 4NO4NC
	Rated current (A) AC110V	6	6	6
	AC11 AC220V	5	5	5
	Mounting size			
	Dimension (W×H×D)	44×80×86.8(113.2)	44×80×118.6(145)	44×80×118.6(145)
Weight (kg)	0.34(0.56)	0.37(0.59)	0.39(0.61)	

Meta-MEC and Metasol TOR comparison table







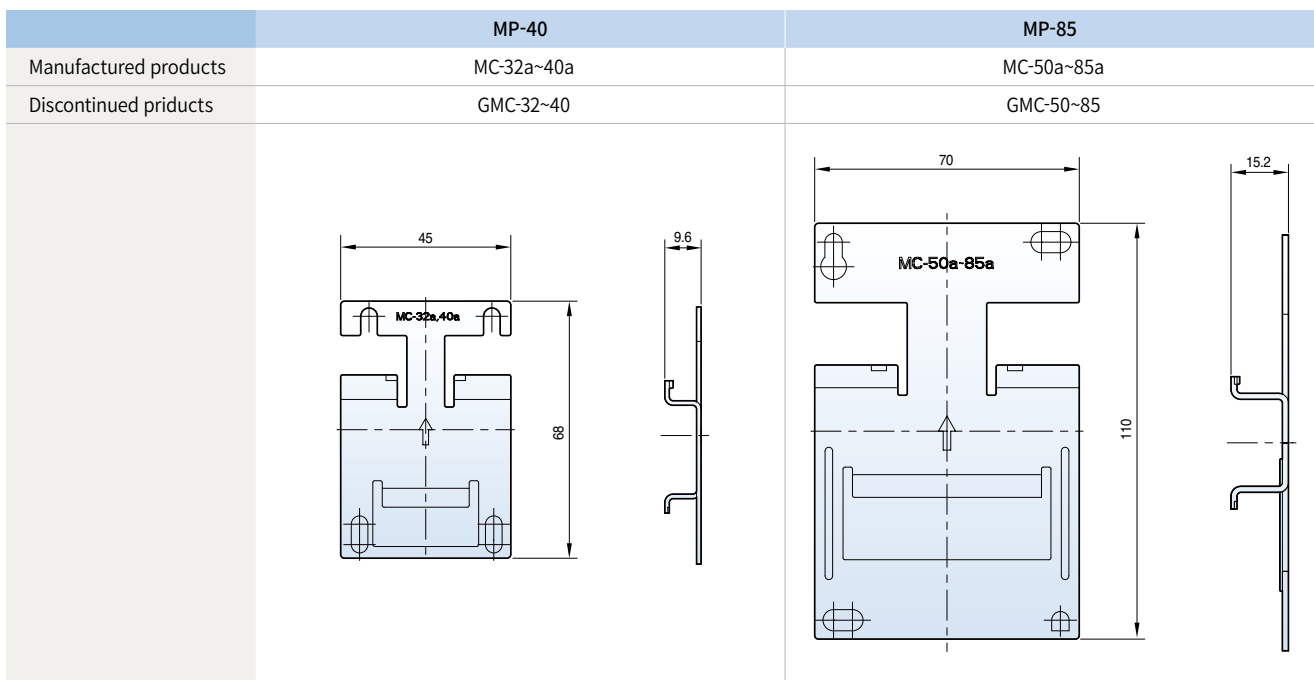

Manufactured products		Discontinued products	
MT		GTH (K)	
MT-12	0.14(0.1~0.16), 0.21(0.16~0.25), 0.33(0.25~0.4), 0.52(0.4~0.63), 0.82(0.63~1), 1.3(1~1.6), 2.1(1.6~2.5), 3.3(2.5~4), 5(4~6), 6.5(5~8), 7.5(6~9), 8.5(7~10), 11(9~13), 15(12~18), 19(16~22)	GTH(K)-22	0.14(0.1~0.16), 0.21(0.16~0.25), 0.33(0.25~0.4), 0.52(0.4~0.63), 0.82(0.63~1), 1.3(1~1.6), 2.1(1.6~2.5), 3.3(2.5~4), 5(4~6), 6.5(5~8), 7.5(6~9), 8.5(7~10), 11(9~13), 15(12~18), 19(16~22)
MT-32	0.14(0.1~0.16), 0.21(0.16~0.25), 0.33(0.25~0.4), 0.52(0.4~0.63), 0.82(0.63~1), 5(4~6), 6.5(5~8), 7.5(6~9), 8.5(7~10), 11(9~13), 15(12~18), 19(16~22), 22(18~26), 34(28~40)	GTH(K)-40	5(4~6), 6.5(5~8), 7.5(6~9), 8.5(7~10), 11(9~13), 15(12~18), 19(16~22), 22(18~26), 30(24~36), 34(28~40)
MT-63	5(4~6), 6.5(5~8), 7.5(6~9), 8.5(7~10), 11(9~13), 15(12~18), 19(16~22), 22(18~26), 30(24~36), 34(28~40), 42(34~50), 54(45~65)	GTH(K)-85	8.5(7~10), 11(9~13), 15(12~18), 19(16~22), 22(18~26), 30(24~36), 34(28~40), 42(34~50), 55(45~65), 65(54~75), 74(63~85)
MT-95	8.5(7~10), 11(9~13), 15(12~18), 19(16~22), 22(18~26), 30(24~36), 34(28~40), 42(34~50), 54(45~65), 65(54~75), 74(63~85), 83(70~95), 90(80~100)	GTH(K)-100	41(34~50), 48(39~57), 56(43~65), 67(54~80), 80(65~100), 107(85~125)
MT-150	42(34~50), 55(45~65), 65(54~75), 74(63~85), 93(80~105), 113(95~130), 130(110~150)	GTH(K)-150	41(34~50), 48(39~57), 56(43~65), 67(54~80), 80(65~100), 107(85~125), 130(100~150)
MT-225	80(65~100), 107(85~125), 130(100~160), 153(120~185), 200(160~240)	GTH(K)-220	80(65~100), 107(85~125), 130(100~160), 150(120~180), 200(160~240)
MT-400	107(85~125), 130(100~160), 153(120~185), 200(160~240), 265(200~330), 350(260~400)	GTH(K)-400	107(85~125), 130(100~160), 150(120~180), 200(160~240), 250(200~300), 350(260~400)
MT-800	265(200~300), 350(260~400), 515(400~630), 660(520~800)	GTH(K)-600	250(200~300), 350(260~400), 500(400~600), 660(520~800)

Compatibility bracket

- Mounting Metasol MC on Din-Rail of bracket after install the bracket on panel
- Please use compatibility bracket when replace from Meta-MEC to Metasol MC without to change of panel size











Certifications

Type	Type	Approvals					Certificates		
	Certificate	-	IEC	UL	CSA	GB	IEC		KEPIC
Type	Mark and name								
Type		Korea	Europe	U.S.A & Canada	Canada	China	Netherlands	Denmark	Korea
Metasol contactors	MC-6a	●	●	●	●	●	●		●
	MC-9a	●	●	●	●	●	●		●
	MC-12a	●	●	●	●	●	●		●
	MC-18a	●	●	●	●	●	●		●
	MC-9b	●	●	●	●	●	●		●
	MC-12b	●	●	●	●	●	●		●
	MC-18b	●	●	●	●	●	●		●
	MC-22b	●	●	●	●	●	●		●
	MC-32a	●	●	●	●	●	●		●
	MC-40a	●	●	●	●	●	●		●
	MC-50a	●	●	●	●	●	●		●
	MC-65a	●	●	●	●	●	●		●
	MC-75a	●	●	●	●	●	●		●
	MC-85a	●	●	●	●	●	●		●
	MC-100a	●	●	●	●	●	●		●
	MC-130a	●	●	●	●	●	●		●
	MC-150a	●	●	●	●	●	●		●
	MC-185a	●	●	●	●	●	●		●
	MC-225a	●	●	●	●	●	●		●
	MC-265a	●	●	●	●	●	●		●
	MC-330a		●	●	●	●	●		●
	MC-400a		●	●	●	●	●		●
MC-500a		●	●	●	●	●		●	
MC-630a		●	●	●	●	●		●	
MC-800a		●	●	●	●	●		●	
MC-1260a		●	●	●	●	●	●	●	
MC-1400a		●	●	●	●	●	●	●	
MC-1700a		●	●	●	●	●	●	●	
MC-2100a		●	●	●	●	●	●	●	
Thermal overload relays nondifferential (2-heater)	MT-12/2H		●	●	●	●	●		●
	MT-32/2H		●	●	●	●	●		●
	MT-63/2H		●	●	●	●	●		●
	MT-95/2H		●	●	●	●	●		●
	MT-150/2H		●	●	●	●	●		●
	MT-225/2H		●	●	●	●	●		●
Thermal overload relays nondifferential (3-heater)	MT-400/2H		●	●	●	●	●		●
	MT-800/2H		●	●	●	●	●		●
	MT-12/3H		●	●	●	●	●		●
	MT-32/3H		●	●	●	●	●		●
	MT-63/3H		●	●	●	●	●		●
	MT-95/3H		●	●	●	●	●		●
Thermal overload relays differential	MT-150/3H		●	●	●	●	●		●
	MT-225/3H		●	●	●	●	●		●
	MT-400/3H		●	●	●	●	●		●
	MT-800/3H		●	●	●	●	●		●
	MT-12/3K		●	●	●	●	●		●
	MT-32/3K		●	●	●	●	●		●
Thermal overload relays class 20	MT-63/3K		●	●	●	●	●		●
	MT-95/3K		●	●	●	●	●		●
	MT-150/3K		●	●	●	●	●		●
	MT-225/3K		●	●	●	●	●		●
	MT-400/3K		●	●	●	●	●		●
	MT-800/3K		●	●	●	●	●		●
Thermal overload relays class 20	MT-12/3D		●	●	●	●	●		●
	MT-32/3D		●	●	●	●	●		●
	MT-63/3D		●	●	●	●	●		●
	MT-95/3D		●	●	●	●	●		●
	MT-150/3D		●	●	●	●	●		●
	MT-225/3D		●	●	●	●	●		●
MT-400/3D		●	●	●	●	●		●	
MT-800/3D		●	●	●	●	●		●	

Note) ●: Completion

Certifications

Marine

Type		Approvals							
Type	Mark and name								
		KR Korea	LR U.K	BV France	GL Germany	DNV Norway	ABS U.S.A	NK Japan	RINA Italy
Metasol contactors	MC-6a	●	●	●	●	●	●	●	●
	MC-9a	●	●	●	●	●	●	●	●
	MC-12a	●	●	●	●	●	●	●	●
	MC-18a	●	●	●	●	●	●	●	●
	MC-9b	●	●	●	●	●	●	●	●
	MC-12b	●	●	●	●	●	●	●	●
	MC-18b	●	●	●	●	●	●	●	●
	MC-22b	●	●	●	●	●	●	●	●
	MC-32a	●	●	●	●	●	●	●	●
	MC-40a	●	●	●	●	●	●	●	●
	MC-50a	●	●	●	●	●	●	●	●
	MC-65a	●	●	●	●	●	●	●	●
	MC-75a	●	●	●	●	●	●	●	●
	MC-85a	●	●	●	●	●	●	●	●
	MC-100a	●	●	●	●	●	●	●	●
	MC-130a	●	●	●	●	●	●	●	●
	MC-150a	●	●	●	●	●	●	●	●
	MC-185a	●	●	●	●	●	●	●	●
	MC-225a	●	●	●	●	●	●	●	●
	MC-265a	●	●	●	●	●	●	●	●
MC-330a	●	●	●	●	●	●	●	●	
MC-400a	●	●	●	●	●	●	●	●	
MC-500a	●	●	●	●	●	●	●	●	
MC-630a	●	●	●	●	●	●	●	●	
MC-800a	●	●	●	●	●	●	●	●	
Thermal overload relays nondifferential (2-heater)	MT-12/2H	●	●	●	●	●	●	●	●
	MT-32/2H	●	●	●	●	●	●	●	●
	MT-63/2H	●	●	●	●	●	●	●	●
	MT-95/2H	●	●	●	●	●	●	●	●
	MT-150/2H	●	●	●	●	●	●	●	●
	MT-225/2H	●	●	●	●	●	●	●	●
	MT-400/2H	●	●	●	●	●	●	●	●
MT-800/2H	●	●	●	●	●	●	●	●	
Thermal overload relays nondifferential (3-heater)	MT-12/3H	●	●	●	●	●	●	●	●
	MT-32/3H	●	●	●	●	●	●	●	●
	MT-63/3H	●	●	●	●	●	●	●	●
	MT-95/3H	●	●	●	●	●	●	●	●
	MT-150/3H	●	●	●	●	●	●	●	●
	MT-225/3H	●	●	●	●	●	●	●	●
	MT-400/3H	●	●	●	●	●	●	●	●
MT-800/3H	●	●	●	●	●	●	●	●	
Thermal overload relays differential	MT-12/3K	●	●	●	●	●	●	●	●
	MT-32/3K	●	●	●	●	●	●	●	●
	MT-63/3K	●	●	●	●	●	●	●	●
	MT-95/3K	●	●	●	●	●	●	●	●
	MT-150/3K	●	●	●	●	●	●	●	●
	MT-225/3K	●	●	●	●	●	●	●	●
	MT-400/3K	●	●	●	●	●	●	●	●
MT-800/3K	●	●	●	●	●	●	●	●	
Thermal overload relays class 20	MT-12/3D	●	●	●	●	●	●	●	●
	MT-32/3D	●	●	●	●	●	●	●	●
	MT-63/3D	●	●	●	●	●	●	●	●
	MT-95/3D	●	●	●	●	●	●	●	●
	MT-150/3D	●	●	●	●	●	●	●	●
	MT-225/3D	●	●	●	●	●	●	●	●
	MT-400/3D	●	●	●	●	●	●	●	●
MT-800/3D	●	●	●	●	●	●	●	●	

Note) ●: Completion

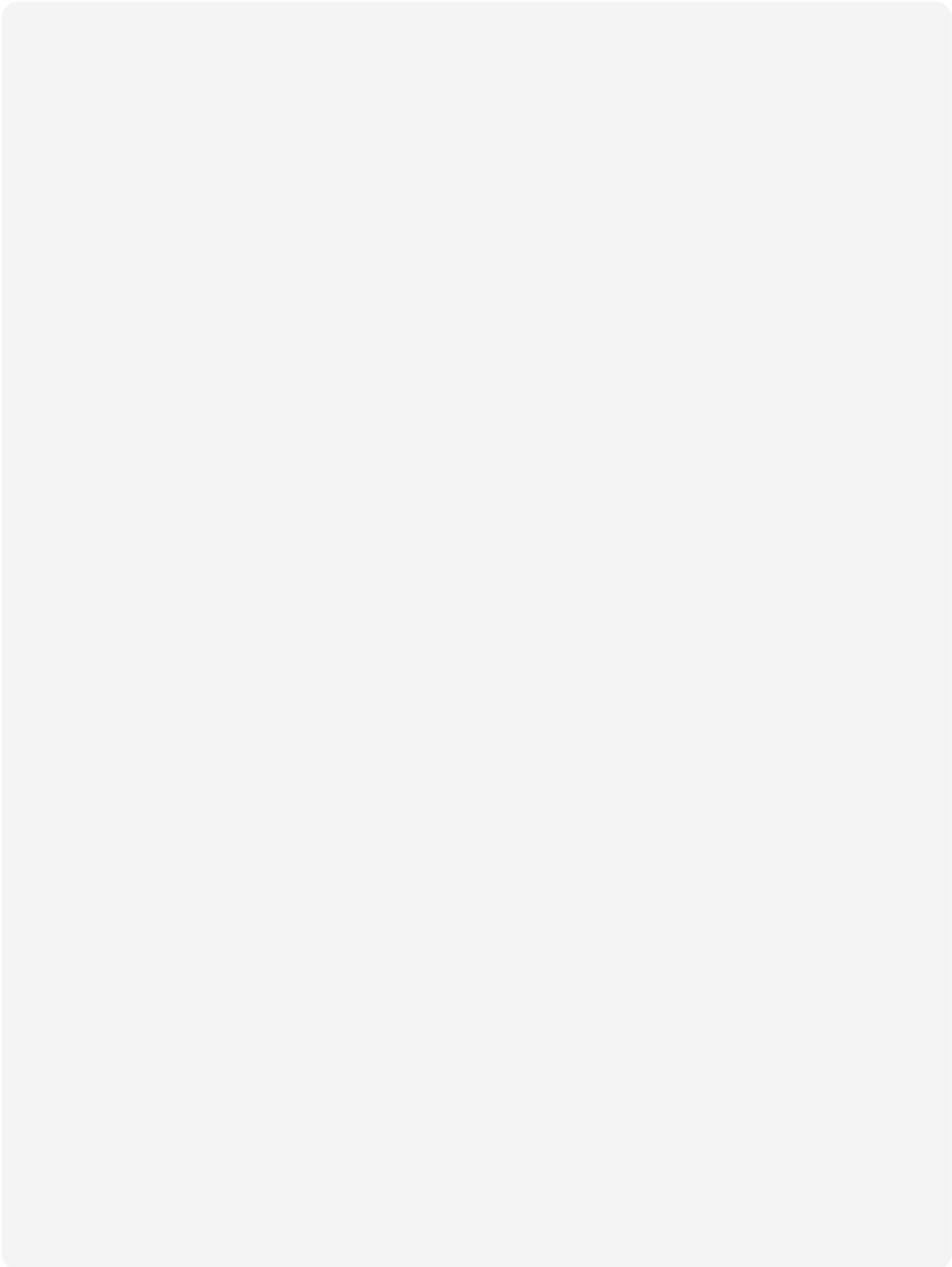



Safety Instructions

- For your safety, please read user's manual thoroughly before operating.
- Contact the nearest authorized service facility for examination, repair, or adjustment.
- Please contact qualified service technician when you need maintenance. Do not disassemble or repair by yourself!
- Any maintenance and inspection shall be performed by the personnel having expertise concerned.



- According to The WEEE Directive, please do not discard the device with your household waste.



www.ls-electric.com

■ **Headquarter**

LS-ro 127(Hogye-dong) Dongan-gu, Anyang-si, Gyeonggi-Do, 14119, Korea

■ **Seoul Office**

LS Yongsan Tower, 92, Hangang-daero, Yongsan-gu, Seoul, 04386, Korea
Tel: 82-2-2034-4916, 4684, 4429

■ **Overseas Subsidiaries**

- **LS ELECTRIC Japan Co., Ltd. (Tokyo, Japan)**
Tel: 81-3-6268-8241 E-Mail: japan@ls-electric.com
- **LS ELECTRIC (Dalian) Co., Ltd. (Dalian, China)**
Tel: 86-411-8730-5872 E-Mail: china.dalian@lselectric.com.cn
- **LS ELECTRIC (Wuxi) Co., Ltd. (Wuxi, China)**
Tel: 86-510-6851-6666 E-Mail: china.wuxi@lselectric.com.cn
- **LS ELECTRIC Vietnam Co., Ltd. (Hanoi, Vietnam)**
Tel: 84-93-631-4099 E-Mail: vietnam@ls-electric.com
- **LS ELECTRIC Middle East FZE (Dubai, U.A.E.)**
Tel: 971-4-886-5360 E-Mail: middleeast@ls-electric.com
- **LS ELECTRIC Europe B.V. (Hoofddorp, Netherlands)**
Tel: 31-20-654-1424 E-Mail: europartner@ls-electric.com
- **LS ELECTRIC America Inc. (Chicago, USA)**
Tel: 1-800-891-2941 E-Mail: sales.us@lselectricamerica.com
- **LS ENERGY Solutions LLC (Charlotte, USA)**
Tel: 1-704-587-4051 E-Mail: cmfeldman@ls-es.com
- **LS ELECTRIC Turkey Co., Ltd. (Istanbul, Turkey)**
Tel: 90-212-806-1252 E-Mail: turkey@ls-electric.com

■ **Overseas Branches**

- **LS ELECTRIC Tokyo Office (Japan)**
Tel: 81-3-6268-8241 E-Mail: tokyo@ls-electric.com
- **LS ELECTRIC Beijing Office (China)**
Tel: 86-10-5095-1631 E-Mail: china@lselectric.com.cn
- **LS ELECTRIC Shanghai Office (China)**
Tel: 86-21-5237-9977 E-Mail: china@lselectric.com.cn
- **LS ELECTRIC Guangzhou Office (China)**
Tel: 86-20-3818-2883 E-Mail: china@lselectric.com.cn
- **LS ELECTRIC Chengdu Office (China)**
Tel: 86-28-8670-3201 E-Mail: china@lselectric.com.cn
- **LS ELECTRIC Qingdao Office (China)**
Tel: 86-532-8501-2065 E-Mail: china@lselectric.com.cn
- **LS ELECTRIC Nanjing Office (China)**
Tel: 86-25-8467-0005 E-Mail: china@lselectric.com.cn
- **LS ELECTRIC Bangkok Office (Thailand)**
Tel: 66-90-950-9683 E-Mail: thailand@ls-electric.com
- **LS ELECTRIC Jakarta Office (Indonesia)**
Tel: 62-21-2933-7614 E-Mail: indonesia@ls-electric.com
- **LS ELECTRIC Moscow Office (Russia)**
Tel: 7-499-682-6130 E-Mail: info@lselectric-ru.com
- **LS ELECTRIC America Western Office (Irvine, USA)**
Tel: 1-949-333-3140 E-Mail: america@ls-electric.com
- **LS ELECTRIC India Office (India)**
Tel: 91-80-6142-9108 E-Mail: Info_india@ls-electric.com
- **LS ELECTRIC Singapore Office (Singapore)**
Tel: 65-6958-8162 E-Mail: singapore@ls-electric.com
- **LS ELECTRIC Italy office (Italy)**
Tel: 39-030-8081-833 E-Mail: italia@ls-electric.com



Technical Question or After-sales Service

Customer Center-Quick Responsive Service, Excellent technical support

82-1644-5481